

UNIVERSITY OF NOVI SAD  
TECHNICAL FACULTY „MIHAILO PUPIN“  
ZRENJANIN, REPUBLIC OF SERBIA

with partners

Politehnica University, Timisoara, Romania  
Obuda University, Hungary  
Mogilev State University of Food Technologies,  
Belarus

Proceedings



5<sup>th</sup> INTERNATIONAL CONFERENCE

# “ECOLOGY OF URBAN AREAS 2016”

Zrenjanin, 30th September 2016  
Serbia

**UNIVERSITY OF NOVI SAD  
FACULTY OF TECHNICAL SCIENCES "MIHAJLO PUPIN"  
ZRENJANIN, REPUBLIC OF SERBIA  
with partners  
POLITECHNICA UNIVERSITY, TIMISOARA, ROMANIA  
OBUDA UNIVERSITY, HUNGARY  
MOGILEV STATE UNIVERSITY OF FOOD TECHNOLOGIES,  
BELARUS**

**V International Conference  
„Ecology of Urban Areas 2016“**

# **P R O C E E D I N G S**

**Zrenjanin,  
30th September 2016**

---

**Organizer:**

University of Novi Sad, Faculty of Technical Sciences "Mihajlo Pupin", Zrenjanin, Republic of Serbia

**Partners:**

Politehnica University, Timisoara, Romania

Obuda University, Hungary

Mogilev State University of Food Technologies, Belarus

**Publisher:**

University of Novi Sad, Faculty of Technical Sciences "Mihajlo Pupin"

Djуре Djakovica bb, Zrenjanin, Republic of Serbia

**For publisher:**

Milan Pavlović, Ph.D, Full Professor, President of Organizing Committee of the Conference

**Reviewers:**

Ph.D Milan Pavlović, Faculty of Technical Sciences "Mihajlo Pupin", University of Novi Sad, Republic of Serbia

Ph.D Vjekoslav Sajfert, Faculty of Technical Sciences "Mihajlo Pupin", University of Novi Sad, Republic of Serbia

Ph.D Duško Letić, Faculty of Technical Sciences "Mihajlo Pupin", University of Novi Sad, Republic of Serbia

Ph.D Vladimir Šinik, Faculty of Technical Sciences "Mihajlo Pupin", University of Novi Sad, Republic of Serbia

Ph.D Bogdana Vujić, Faculty of Technical Sciences "Mihajlo Pupin", University of Novi Sad, Republic of Serbia

**Technical preparation and design:**

Kazi Zoltan

**Cover design:**

Stanislava Sindelić, Kazi Zoltan

**Circulation:** 60

The Conference is supported by the Ministry of Education, Science and Technological Development of Republic of Serbia; Ministry of Energy, Development and Environmental Protection; Provincial Secretariat for Science and Technological Development; Provincial Secretariat for Protection of Environment and Sustainable Development.

**ISBN 978-86-7672-291-4**

CIP - Каталогизacija у публикацији  
Библиотека Матице српске, Нови Сад

502.22:711.4(082)

**INTERNATIONAL Conference "Ecology of Urban Areas" (5 ; 2016 ; Zrenjanin)**

Proceedings [Elektronski izvor] / V International Conference "Ecology of Urban Areas 2016", Zrenjanin, 30th September 2016 ; [organizer] Faculty of Technical Sciences "Mihajlo Pupin", Zrenjanin with partners Politehnica University, Timisoara, Romania ... [et al.]. - Zrenjanin : Faculty of Technical Sciences "Mihajlo Pupin", 2016. - 1 elektronski optički disk (CD-ROM) : tekst, slika ; 12 cm

Nasl. sa naslovnog ekrana. - Tiraž 60. - Bibliografija uz svaki rad. - Registar.

ISBN 978-86-7672-291-4

a) Урбана екологија - Зборници  
COBISS.SR-ID 308621831

## **International Scientific Committee**

Ph.D Ioana Ionel, Politehnica University of Timisoara, Romania

Ph.D Dorin Lelea, Politehnica University of Timisoara, Romania

Ph.D Mirjana Vojinovic Miloradov, professor emeritus, FTN, University of Novi Sad, Republic of Serbia

Ph.D Milan Pavlovic, dean TF "M. Pupin", University of Novi Sad, Republic of Serbia

Ph.D Sadhan K Ghosh, Centre for Quality Management System, Jadavpur University, India

Ph.D Alexandr Mironchik, Mogilev State University of Food Technologies, Belarus

Ph.D Lubomír Šooš, Faculty of Mechanical Engineering, Bratislava, Slovak Republic

Ph.D Milan Kljajin, J. J. Strossmayer University of Osijek, Faculty of Mechanical Engineering in Slavonski Brod, Croatia

Ph.D Hosam E.A.F. Bayoumi Hamuda, Obuda University, Hungary

Ph.D Milan Opalic, Faculty of Mechanical Engineering and Naval Architecture, University of Zagreb, Croatia

Ph.D Caner Zambak, Vice-president of B.E.N.A, Turkey

Ph.D G. Vasilikiotis, Vice-president of B.E.N.A, Greece

Ph.D Klaus Kuhnke, Hochschule Osnabruck, Germany

Ph.D Roberto Raga, Universita Degli Studi Di Padova, Italy

Ph.D Kiril Lisickov, Ss. Cyril and Methodius University in Skopje, Faculty of Technology and Metallurgy – Skopje, Republic of Macedonia

Ph.D Stojan Simic, University of East Sarajevo, BIH

Ph.D Borut Kosec, University of Ljubljana, Faculty of Natural Sciences and Engineering, Slovenia

Ph.D Miroslav Stanojević, Faculty of Mechanical engineering, University of Belgrade

Ph.D Biserka Dimiskovska, University "Ss. Cyril and Methodius", Institute of Earthquake Engineering and Engineering Seismology, Republic of Macedonia

Ph.D Željko Kamberović, Faculty of Technology and Metallurgy, University of Belgrade

Ph.D Slavko Arsovski, Faculty of Mechanical Engineering in Kragujevac, University of Kragujevac, Republic of Serbia

Ph.D Vjekoslav Sajfert, TF "M. Pupin", University of Novi Sad, Republic of Serbia

Ph.D Duško Letić, TF "M. Pupin", University of Novi Sad, Republic of Serbia

Ph.D Bogdana Vujić, TF "M. Pupin", University of Novi Sad, Republic of Serbia

Ph.D Vlastimir Nikolić, Mechanical Engineering Faculty, University of Niš, Republic of Serbia

Ph.D Ljiljana Živković, Faculty of Occupational Safety, University of Niš, Republic of Serbia

Ph.D Nenad Živković, Faculty of Occupational Safety, University of Niš, Republic of Serbia

## **Organizing Committee**

Ph.D Milan Pavlović, president, Faculty of Technical Sciences “Mihajlo Pupin”, University of Novi Sad, Republic of Serbia

Ph.D Vjekoslav Sajfert, Faculty of Technical Sciences “Mihajlo Pupin”, University of Novi Sad, Republic of Serbia

Ph.D Duško Letić, Faculty of Technical Sciences “Mihajlo Pupin”, University of Novi Sad, Republic of Serbia

Ph.D Fransisc Popescu, Politehnica University of Timisoara, Romania

Ph.D Bogdana Vujić, Faculty of Technical Sciences “Mihajlo Pupin”, University of Novi Sad, Republic of Serbia

Ph.D Vladimir Šinik, Faculty of Technical Sciences “Mihajlo Pupin”, University of Novi Sad, Republic of Serbia

Ph.D Zoltan Kazi, Faculty of Technical Sciences “Mihajlo Pupin”, University of Novi Sad, Republic of Serbia

MSc Olivera Paunović, Faculty of Technical Sciences “Mihajlo Pupin”, University of Novi Sad, Republic of Serbia

MSc Una Marčeta, Faculty of Technical Sciences “Mihajlo Pupin”, University of Novi Sad, Republic of Serbia

MSc Miroslav Vulić, Faculty of Technical Sciences “Mihajlo Pupin”, University of Novi Sad, Republic of Serbia

MA Aleksandar Đurić, Faculty of Technical Sciences “Mihajlo Pupin”, University of Novi Sad, Republic of Serbia

## INTRODUCTION

University of Novi Sad, Technical faculty “Mihajlo Pupin” from Zrenjanin, in partnership with Politehnica University from Timisoara in Romania, Obuda University from Hungary and Mogilev State University of Food Technologies from Belarus has organized the Fifth International Conference of Ecology of Urban Areas 2016 (URBANECO 2016). This partnership significantly improves the quality of conference organization and work, as well as contribution in area of regional cooperation with other universities and scientific institutions.

The objectives of the Conference URBANECO 2016 are: presentation of current knowledge and the exchange of experiences from the field of sustainable development of urban areas which is one of the major problems of modern civilization. The ecological aspect is the dominant factor in achieving sustainability. The importance of ecological aspect has developed a need for an International Conference "Ecology of Urban Areas 2016" which has the goal to integrate scientific, technological and experimental knowledge in this field. Another importance is gathering researchers from this field with aim of expanding regional and international cooperation, raising the level of professional and scientific work at University of Novi Sad and Technical faculty “Mihajlo Pupin”, expanding cooperation with institutions and encouraging young researchers within this field. Taking into account that this Conference is international, the importance of this event is obvious for the town of Zrenjanin, Banat region, Vojvodina and Serbia. Organization of URBANECO 2016 by University of Novi Sad, Technical faculty “Mihajlo Pupin” from Zrenjanin represents this scientific-educational institution as one of the major representatives of economic and social development in Banat.

Within this Collection of papers are presented all accepted papers received for V International Conference Ecology of Urban Areas 2016. The papers are divided into following sessions: Air quality, Management of solid urban waste, Water quality in urban areas (ground water, drinking water, waste water and facilities), Economics of sustainable development of urban areas, Noise and vibrations in urban areas, Electro and electro-magnetic pollution in urban areas, Climate changes and urban pollution, Spatial planning and greening in urban areas, Development of urban ecology through educative and information activities, ICT in the ecology of urban areas, Accidents in urban areas, Environmental aspects of traffic in urban areas, Impact of agricultural activities to urban area, Public health and the ecology of urban areas, Soil and degradation of soil, and Transfer stations in the system of management of solid communal waste.

We would like to express our gratitude to the Ministry of Education, Science and Technological Development of Republic of Serbia; Ministry of Energy, Development and Environmental Protection; Provincial Secretariat for Science and Technological Development; Provincial Secretariat for Protection of Environment and Sustainable Development.

Finally, we wish to thank all the authors of papers and participants in the Conference in hope that we will continue our cooperation successfully in the future and that each new year will bring better ideas and solutions to help raise awareness of the responsibility we hold today for the well-being of future generations.

Zrenjanin, September 2016.

President of the Organizing Committee  
Ph.D Milan Pavlović

## WORD OF THANKS

**We wish to thank Provincial Secretariat for Science and Technological Development, Republic of Serbia for supporting the organization of V International Conference „ECOLOGY OF URBAN AREAS 2016“**

**Conference participants are from the following countries:**



Serbia



Romania



Bulgaria



Hungary



Belarus



Turkey



Bosnia and Herzegovina



Libya



Croatia



Spain



FYR Macedonia



Montenegro



Iran



Norway

## CONTENTS

<b>AIR QUALITY.....</b>	<b>11</b>
FILTERING SYSTEM IN URBAN AREAS .....	12
Ioana Ionel, László Makra, Milan Pavlovic, Daniel Bisorca, Ramon Mihai Balogh, Nicolae Stelian Lontis, Aleksandar Đuric	
ANALYZING THE LEVEL OF HIGH TROPOSPHERIC OZONE DURING THE SUMMER 2013 IN SKOPJE, R.MACEDONIA .....	21
Bobi Stoimenovski, Kosta Mitreski, Andreja Naumoski, Danco Davcev	
EMISSION DISPERSION MODELLING OF A COAL FIRED 420 T/H STEAM BOILER IN A COAL/BIO MASS CO-FIRING SCENARIO. AIR QUALITY ASSESSMENT .....	26
Francisc Popescu, Bogdana Vujic, Milan Pavlovic, Adrian Eugen Cioabla, Aleksandar Djuric, Adrian Tenchea	
SIMULATION OF AIR POLLUTION DISPERSION FROM POINT SOURCES AND CROSS-BORDER IMPACT USING SIMULATION SOFTWARE ADMS 5 .....	30
Aleksandar Đurić, Bogdana Vujić, Francisc Popescu, Una Marčeta, Miroslav Vulić	
THE INFLUENCE OF WIND POWER ON THE ENVIRONMENT .....	38
E. Škrgić, S. Mirjanić	
CERTAIN MODELS IN THE ANALYSIS OF AIR POLLUTION .....	46
Stevo K. Jaćimovski, Vjekoslav D. Sajfert, Jovan P. Šetrajić, Slobodan Miladinović	
<b>MANAGEMENT OF SOLID URBAN WASTE .....</b>	<b>54</b>
DEVELOPMENT OF SUSTAINABLE WASTE MANAGEMENT SYSTEM IN NOVI SAD WASTE MANAGEMENT CENTRE .....	55
Višnja Mihajlović, Mladenka Novaković	
ENVIRONMENTAL IMPACT OF RECYCLING ACCUMULATORS AND BATTERIES WASTE.....	60
Žarko Vranjanac, Nenad Živković, Ljiljana Živković	
SUSTAINABLE TECHNOLOGIES IN RECYCLING OF MOTOR VEHICLES, ELV .....	69
Milan Pavlović, Miroslav Vulić, Slavko Arsovski, Aleksandar Tomović	
<b>WATER QUALITY IN URBAN AREAS (GROUND WATER, DRINKING WATER, WASTE WATER AND FACILITIES).....</b>	<b>74</b>
BACTERIOLOGICAL MONITORING AND WATER QUALITY OF DANUBE RIVER AT BUDAPEST TERRITORY .....	75
Hosam BAYOUMI HAMUDA	
SLUDGE REDUCTION AND GENERAL PERFORMANCE IN A COMBINED US+OSA SYSTEM .....	88
Pablo Maria Romero Pareja, Carlos Alberto Aragón Cruz, José María Quiroga Alonso, Maria Dolores Coello Oviedo	
CO-SUBSTRATES INFLUENCE ON METHANE GENERATION THROUGH WASTE WATER ANAEROBIC DIGESTION .....	94
Adriana Raluca Wächter, Reinhold Wächter, Ioana Ionel	
GROUNDWATER QUALITY WITH RESPECT TO THE LEVELS OF NITRATE AND FLUORIDE IN URBAN AREA OF MALAYER CITY AND THE ASSOCIATED HEALTH RISK .....	102
Mohamad Sakizadeh, Fatemeh Mehrabi Sharafabadi, Eshagh Shayegan	
APPLICATION OF NATURAL INORGANIC SORBENT (PEMZA) FOR REMOVAL OF CR(VI) IONS FROM WATER RESOURCES .....	109
Hamdije Memedi, Katerina Atkovska, Kiril Lisichkov, Mirko Marinkovski, Zoran Bozinovski, Stefan Kuvendziev, Arianit Reka, Shaban Jakupi	
THE APPLICATION OF EDUCATIONAL EQUIPMENT FOR WASTEWATER TREATMENT.....	117
Marina Šćiban, Vesna Vasić, Dragana Kukić, Jelena Prodanović, Zita Šereš	
NOVEL TRENDS IN WASTEWATER TREATMENT BY USING MEMBRANE BIOREACTORS.....	124
Erhan Mustafa, Kiril Lisichkov, Mirko Marinkovski, Stefan Kuvendziev, Zoran Bozinovski	



BAUXITE BASED GEOPOLYMER AS A NOVEL ADSORBENT FOR HEAVY METALS REMOVAL FROM AQUATIC SOLUTIONS .....	129
Irena Nikolić, Milena Tadić, Ivana Milašević, Dijana Đurović, Zoltan Kazi, Bogdana Vujić	
MEASUREMENT OF FREE CHLORINE IN SWIMMING POOL WATER BY FIBER OPTIC SENSOR .....	133
Boris Obrovski, Ivana Mihajlović, Jovan Bajić, Mirjana Vojinović Miloradov, Dragan Adamović, Branislav Batinić, Miloš Živanov	
EFFICIENCY OF ZNO/SNO <sub>2</sub> NANO POWDER CATALYST FOR PHOTODEGRADATION OF PHARMACEUTICALLY ACTIVE WATER POLLUTANTS .....	138
Mladenka Novaković, Veselin Bežanović, Tamara Ivetić, Ivana Mihajlović, Goran Štrbac, Dragana Štrbac, Maja Đogo	
KINETIC AND EQUILIBRIUM STUDIES OF CD <sup>2+</sup> ADSORPTION ONTO LOW-COST ADSORBENT PREPARED FROM PLUM KERNELS .....	143
Sabolc Pap, Nikola Boskovic, Jelena Radonic, Dragan Adamovic, Maja Sremacki, Olivera Paunovic, Maja Turk Sekulic	
SEPARATION OF PESTICIDE CARBENDAZIM FROM WATER BY ACTIVATED CARBON.....	151
Ali Hgeig, Mladenka Novaković, Mirjana Vojinović Miloradov, Ivana Mihajlović	
COMPARISON OF EXPERIMENTAL AND THEORETICAL OXYGEN SATURATION, IN THE AERATION TREATMENT OF REFINERY WASTE WATER .....	155
Mirjana M. Ševaljević, Milan Pavlović, Stojan N. Simić, Miroslav M. Stanojević, Miladin V. Ševaljević	
<b>SOIL AND DEGRADATION OF SOIL .....</b>	<b>159</b>
EFFECT OF HEAVY METALS AND TEMPERATURES ON TRACE GAS EMISSIONS FROM AGRICULTURAL SOIL.....	160
Abdousalam A. ALGAIDI, Hosam BAYOUMI HAMODA, Hamed ABDORHIM	
ECOLOGICAL AND FUNCTIONAL ROLES OF PGPR IN BROWN FOREST SOIL ECOSYSTEM OF GÖDÖLLŐ, HUNGARY .....	166
Hosam BAYOUMI HAMUDA, Abdoussalam A. KHALIF	
ADSORPTION PROPERTIES OF MODIFIED FORMS OF ZEOLITE NH <sub>4</sub> NAY.....	175
Blagica Cekova, Erhan Mustafa, Viktorija Bezhovska, Filip Jovanovski	
LAND USE ANALYSES OF BUILT UP AREAS IN THE 19-20 <sup>TH</sup> CENTURIES IN THE GÖDÖLLŐ HILLSIDE, HUNGARY.....	179
Krisztina Demény	
HEAVY METALS IN AGRICULTURAL SOIL.....	184
Gordana Ludajić, Lato Pezo, Jelena Filipović, Jelena Kiurski-Milošević, Aleksandra Šučurović	
CONTAMINATION INDICES AND HEAVY METAL CONCENTRATIONS IN THE LEAVS OF PERENNIAL PLANT SPECIES IN THE URBAN ZONE OF SABAC, SERBIA .....	189
Mirjana Antonijević Nikolić, Kosana Popović, Dušan Stanojević	
AVAILABLE CONCENTRATIONS OF CU, MN, NI, PB AND ZN .....	195
IN SOILS NEAR URBAN ROADS Aleksandra Mihailović, Bogdana Vujić, Jordana Ninkov, Milica Vučinić Vasić, Stanko Milić, Savka Adamović, Robert Lakatoš	
THE QUALITY OF AGRICULTURAL SOILS NEAR INDUSTRIAL ZONES OF THE CITY OF NOVI SAD.....	201
Jordana Ninkov, Aleksandra Mihailović, Dušana Banjac, Milorad Živanov, Ivana Stanivuković, Snežana Jakšić, Jelena Marinković	
<b>CLIMATE CHANGES AND URBAN POLLUTION .....</b>	<b>208</b>
PROTECTION FROM CLIMATE CHANGES IN THE REPUBLIC OF SERBIA AND INTERNATIONAL LAW .....	209
Nadezda Ljubojev, Bogdana Vujic, Dragica Ivin	
<b>ECONOMICS OF SUSTAINABLE DEVELOPMENT OF URBAN AREAS.....</b>	<b>218</b>
STATISTICAL ANALYSIS FOR BIOGAS PRODUCTION FROM TWO DIFFERENT BATCHES UNDER THE SAME CONDITIONS .....	219
Gavrila Trif-Tordai, Adrian Eugen Cioabla, Delia-Gabriela Calinoiu	

GLOBAL ISSUES AND URBANIZATION: RELATION BETWEEN GLOBAL SOCIETAL CHALLENGES AND SOIL SECURITY FOR SUSTAINABLE DEVELOPMENT .....	225
Hosam BAYOUMI HAMUDA	
COMPARATIVE RESULTS IN ANAEROBIC FERMENTATION OF SOME AGRO-INDUSTRIAL RECIPES INSIDE A PILOT INSTALLATION.....	240
Adrian Eugen Cioabla, Dorin Lelea, Francisc Popescu, Gavrilă Trif-Tordai, Alina Gabriela Dumitreț	
SEGMENTS OF SUSTAINABLE DEVELOPMENT OF THE CITY OF ZRENJANIN .....	245
Mila Kavalić, Sanja Stanisavljev, Marko Vlahović, Branko Markoski, Erika Tobolka	
<b>ELECTRO AND ELECTRO-MAGNETIC POLLUTION IN URBAN AREAS.....</b>	<b>251</b>
THE CONCEPT OF A POWER PLANT BASED ON THE SEEBECK – PELTIER EFFECT .....	252
Cătălin – Virgil Rădulescu, Ioana Ionel	
POSSIBILITIES OF VALUABLE RAW MATERIAL EXTRACTION IN THE PROCESS OF RECYCLING OF REFRIGERATORS .....	259
Tijana Marinković, Bojan Batinić, Una Marčeta, Mladenka Novaković, Čedomir Ribić	
<b>ACCIDENTS IN URBAN AREAS .....</b>	<b>266</b>
ACCIDENTAL EVENTS OF PRIMARY SHORT-CIRCUIT OF ELECTRICAL INSTALLATIONS – FORENSIC ANALYSIS.....	267
V.M. Zorić, S.S. Dmitrašinović, V. Petrović, M. Vojinović Miloradov, I. Mihajlović, V. Sajfert	
<b>PUBLIC HEALTH AND THE ECOLOGY OF URBAN AREAS .....</b>	<b>277</b>
HEALING GARDENS IN THE SCOPE OF PUBLIC HEALTH.....	278
Aysun TUNA, Parisa GÖKER	
RAISING AWARENESS ABOUT LINKAGE BETWEEN ENVIRONMENTAL CONTAMINATION RISK AND PROVIDING FOOD SECURITY TO POPULATION IN THE REPUBLIC OF SERBIA .....	284
Vesela Radović, Bogdana Vujić, Ekaterina Arabaska	
EQUILIBRIUM STUDY FOR THE PROCESS OF REMOVAL OF NI(II) IONS FROM AQUEOUS SOLUTIONS BY NATURAL BENTONITE.....	292
Katerina Atkovska, Hamdije Memedi, Kiril Lisichkov, Gordana Ruseska, Stefan Kuvendzjev, Mirko Marinkovski, Anita Grozdanov	
SORPTION BEHAVIOR DEPENDENCE OF PESTICIDE CARBENDAZIM ON DIFFERENT SOIL PROPERTIES .....	298
Nevena Živančev, Srđan Kovačević, Boris Obrovski, Mirjana Vojinović Miloradov, Milan Dimkić	
INDOOR RADON MEASUREMENTS USING SOLID STATE NUCLEAR TRACK DETECTORS IN ELEMENTARY AND SECONDARY SCHOOLS IN ŠABAC, SERBIA .....	303
Svetoslav Lazarev, Luka Nenadović, Jelena Đuričić-Milanković, Bojan Damjanović	
<b>ENVIRONMENTAL ASPECTS OF TRAFFIC IN URBAN AREA.....</b>	<b>308</b>
ANALYSIS OF THE IMPACT OF TRAFFIC DENSITY ON AIR QUALITY AT TOLL BOOTH NAIS ON HIGHWAY E75.....	309
Nikola Mišić, Aca Božilov, Ivica Stamenković, Amelija Đorđević, Nenad Živković, Ljiljana Živković	
<b>NOISE AND VIBRATIONS IN URBAN AREAS .....</b>	<b>317</b>
USING PLANT MATERIALS FOR NOISE POLLUTION IN CITYSCAPE .....	318
Aysun TUNA, Parisa ALIASGHARI KHABBAZI	
NOISE EMISSION WITHIN THE PLANT FOR PRIMARY PROCESSING AND STORAGE OF SCRAP METAL.....	324
Jelena Kiurski-Milošević, Jovanić Dušan, Danijela Jašin, Gordana Ludajić, Aleksandra Šučurović	
EXPOSURE TO WHOLE-BODY VIBRATION, TOOLS FOR CALCULATING DAILY EXPOSURES AND MEASUREMENT.....	331
Vladimir Šinik, Željko Despotović, Slobodan Janković	
HEALTH SURVEILLANCE , HEALTH RISKS, SIGNS AND SYMPTOMS FOR HAND-ARM VIBRATION.....	340
Vladimir Šinik, Slobodan Janković, Željko Despotović	

EXPOSURE TO HAND-ARM VIBRATION, TOOLS FOR CALCULATING DAILY EXPOSURES AND MEASUREMENT.....	348
Vladimir Šinik, Željko Despotović, Slobodan Janković	
<b>SPATIAL PLANNING AND GREENING IN URBAN AREAS.....</b>	<b>358</b>
ECOLOGICAL BUILDING CULTURE AND GREEN BUILDINGS; VERTICAL AND ROOF GARDENS... 359	
Aysun TUNA, Parisa GÖKER	
RESHAPING OF HUMAN CONSCIOUSNESS THROUGH SUSTAINABLE DORMITORY .....	366
Miljan Šunjević, Mirjana Vojinović-Miloradov, Darko Reba, Ivana Mihajlović	
<b>DEVELOPMENT OF URBAN ECOLOGY THROUGH EDUCATIVE AND INFORMATION ACTIVITIES .....</b>	<b>372</b>
SIGNIFICANCE AND ROLE OF INFORMAL PRACTICAL EDUCATION OF SCHOOL POPULATION AS A FACTOR FOR DEVELOPMENT OF URBAN ECOLOGY .....	
Neda Nikolic, Vladan Paunovic, Aleksandar Dragasevic	
ENVIRONMENTAL EDUCATION OF PUPILS IN TECHNOLOGICAL AND INFORMATION TECHNOLOGY TRAINING .....	379
Ivan Tasić, Jelena Jankov, Marjana Pardanjac, Erika Eleven	
SPECIFICS OF EDUCATION OF LOCAL GOVERNMENT HUMAN RESOURCES FOR THE DEVELOPMENT OF URBAN ECOLOGY .....	386
Neda Nikolic, Vladan Paunovic, Aleksandar Dragasevic	
<b>ICT IN THE ECOLOGY OF URBAN AREAS .....</b>	<b>392</b>
SMART HOMES AND SECURITY ISSUES.....	393
Ana Štajminger, Josip Naglić	
AN INTRODUCTION ON LITERATURE OF SMART CITY .....	399
Ali Zeynali Azim, Mostafa Basiri, Mohammad Zeynali Azim	

## **AIR QUALITY**

V International Conference  
„ECOLOGY OF URBAN AREAS“2016

## FILTERING SYSTEM IN URBAN AREAS

Ioana Ionel<sup>1\*</sup>, László Makra<sup>2</sup>, Milan Pavlovic<sup>3</sup>, Daniel Bisorca<sup>1</sup>, Ramon Mihai Balogh<sup>1</sup>,  
Nicolae Stelian Lontis<sup>1</sup>, Aleksandar Đuric<sup>3</sup>

<sup>1</sup> Politehnica University of Timisoara, Faculty for Mechanical Engineering,  
Mihai Viteazu Blvd., No.1, 300222, Timisoara, Romania

<sup>2</sup> Institute of Economics and Rural Development, University of Szeged,  
No. 15 Andrassy Street, 6800 Hódmezővásárhely, Hungary

<sup>3</sup> Technical Faculty Mihajlo Pupin, University of Novi Sad, Djure Djakovica Str., Zrenjanin, Serbia

\*ioana.ionel@upt.ro, makra@geo.u-szeged.hu, milanpavlovic50@gmail.com, daniel\_bisorca@yahoo.co.uk,  
ramon.balogh@upt.ro, nicolae.lontis@upt.ro, alekszr@yahoo.com

### ABSTRACT

*Air pollution is becoming a serious environmental problem, especially in the urban areas because of the impact on the physical and mental health. Pollution with particles, especially smaller than 10  $\mu\text{m}$ , is affecting the health of people. Limits are imposed by national regulations, in order to control the air quality. Standard methods were developed, in order to have a general, comparative significance. The responsibility for complying with the defined limits of air quality goes to national governments and the local administrations, which must launch laws and choose technical and innovative solution capable to guarantee achievement of the objectives imposed by the European Union (Directive 2007.10.12). The creation of air filtering systems is one of the most recent contributions among the different air pollution cleaning methods. The article presents comparative results concerning the effectiveness of such a filtering system, mounted in Timisoara city, in location Sf. Gheorghe Square.*

**Key words:** air quality, PM species, reduction of PM concentrations, fine particles.

### CONTEXT AND SCOPE OF THE RESEARCH

Air pollution is not only an environmentally relevant problem, but also a global health emergency, affecting 84 % of European cities as the defined European limits (PM<sub>10</sub>), for more than 40 days a year, are exceeded. Also it is attested that only in 60 seconds are necessary for the PM<sub>2.5</sub> pollutants to pass the pulmonary barrier and enter into the blood. Pollutant concentrations vary from one country to another, depending on urban density and the presence of industrial zones that cause high pollutant emissions due to air-conditioning systems, residential activities, not at last transportation and industrial and energy processes. According to the general accepted definition, particulate matter - PM, also known as particle pollution, is a complex mixture of air-borne particles and liquid droplets composed of acids (such as nitrates and sulphates), ammonium, water, black (or "elemental") carbon, organic chemicals, metals, and soil (crustal) material (EPA, <https://www3.epa.gov/region1/airquality/pm-what-is.html>). PM, as a dangerous pollutant species is currently classified into two categories (EPA, <https://www3.epa.gov/region1/airquality/pm-what-is.html>).

Figure 1 presents a comparison of these groups' dimensions, even less than 10  $\mu\text{m}$ , versus normal dimensional items:

**Coarse particles** (PM<sub>10-2.5</sub>) such as those found near roadways and dusty industries range in particle size from 2.5 to 10  $\mu\text{m}$ . The coarse particle standard (known as PM<sub>10</sub>) includes all particles less than 10 microns in size.

**Fine particles** (or PM<sub>2.5</sub>) such as those found in smoke and haze have particle size less than 2.5  $\mu\text{m}$ .

PM<sub>2.5</sub> is referred to as **primary** if it is directly emitted into the air as solid or liquid particles, and is called **secondary** if it is formed by chemical reactions of gases in the atmosphere. Major sources of primary fine particles include cars and trucks (especially those with diesel engines); open burning; wildfires; fireplaces, woodstoves, and outdoor wood boilers; cooking; dust from roads and construction; agricultural operations; and coal and oil-burning boilers. Major sources of secondary fine particles are power plants and some industrial processes, including oil refining and pulp and paper production.

About 60% of PM<sub>10</sub> actually consists of PM<sub>2.5</sub>, in other words, dust particles with a diameter of less than 2.5 microns.

Toxic air pollutants get into the body mainly through breathing. They can also be ingested (for example, children eating soil contaminated with lead) or absorbed through the skin (Evaluating Exposures to Toxic Air Pollutants: A Citizen's Guide, Originally published as EPA 450/3-90-023, March 1991).

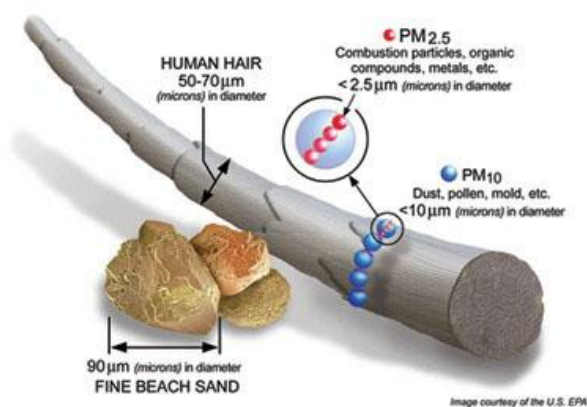

Figure 1. Intuitive comparison for the PM species with dimensions of regular objects, (according <https://airnow.gov/index.cfm?action=aqibasics.particle>, and [https://www.epa.gov/sites/production/files/2016-09/pm2.5\\_scale\\_graphic-color\\_2.jpg](https://www.epa.gov/sites/production/files/2016-09/pm2.5_scale_graphic-color_2.jpg))

The size of particles is directly linked to their potential for causing health problems. Fine particles (PM<sub>2.5</sub>) pose the greatest health risk. These fine particles can get deep into lungs and some may even get into the bloodstream. The EPA document (<https://www3.epa.gov/airnow/particle/pm-color.pdf>) explains more about who is at risk from exposure to fine and coarse particles, and includes simple measures that can be taken to reduce health risks. People with heart or lung diseases, older adults and children are most likely to be affected by particle pollution exposure. However, even if you are healthy, you may feel temporary symptoms if you are exposed to high levels of particle pollution. Numerous scientific studies connect particle pollution exposure to a variety of health issues, including (<https://airnow.gov/index.cfm?action=aqibasics.particle>): irritation of the eyes, nose and throat, coughing, chest tightness and shortness of breath, reduced lung function, irregular heartbeat, asthma attacks, heart attacks, and/or premature death in people with heart or lung disease.

According the data and results from Health effects of particulate matter, Policy implications for countries in Eastern Europe, Caucasus and central Asia, World Health Organization 2013, ([http://www.euro.who.int/\\_\\_data/assets/pdf\\_file/0006/189051/Health-effects-of-particulate-matter-final-Eng.pdf](http://www.euro.who.int/__data/assets/pdf_file/0006/189051/Health-effects-of-particulate-matter-final-Eng.pdf)) Figure 2 presents the population exposure, expressed as annual mean concentration of PM<sub>10</sub>, weighted by the population in cities with data, in 403 cities in 34 WHO European Member States for 2010. In only 9 of these 34 Member States, PM<sub>10</sub> levels in at least some cities are below the

annual WHO air quality guideline (AQG) level of  $20 \mu\text{g}/\text{m}^3$ . Almost 83% of the population of the cities for which PM data exist is exposed to  $\text{PM}_{10}$  levels exceeding the AQG levels. Although this proportion remains high, it is an improvement compared to previous years, with average  $\text{PM}_{10}$  levels slowly decreasing in most countries in the last decade.

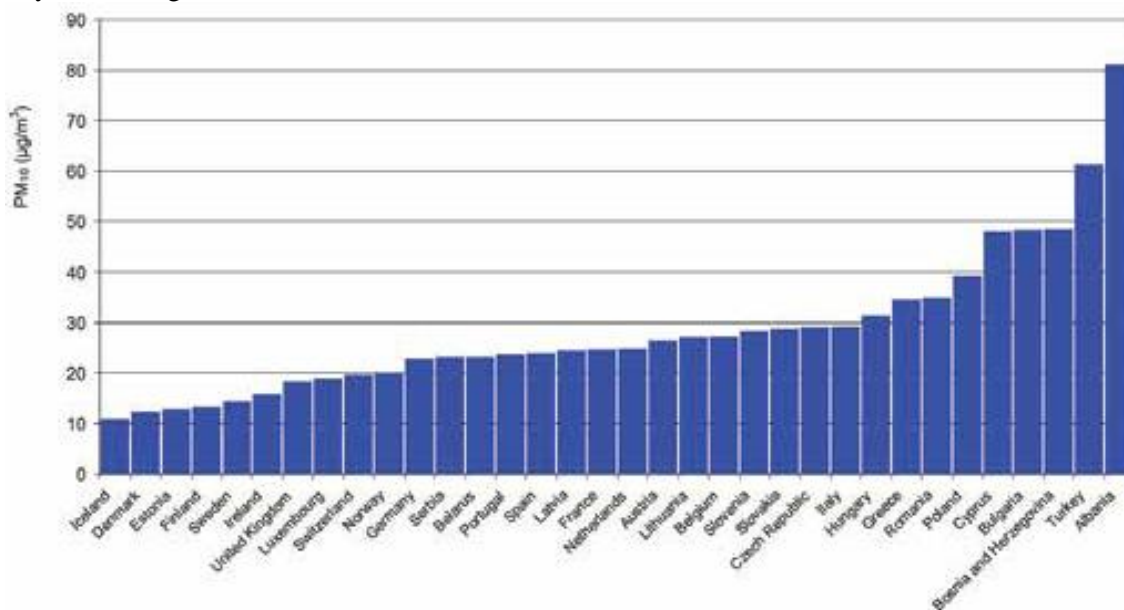

Figure 2. Population-weighted annual mean  $\text{PM}_{10}$  concentrations in cities by WHO European Member States, urban and suburban background locations, 2010 (Health effects of particulate matter. Policy implications for countries in Eastern Europe, Caucasus and Central Asia, World Health Organization 2013, [www.euro.who.int](http://www.euro.who.int))

I. Ionel et al, 2010 reports about the possible mass exchange phenomena in lungs, outlining the possibility of special matter mass transfer. The smaller the particle, the larger is the surface area available for interaction with the respiratory tract, and for adsorption of biologically active substances ([http://www.euro.who.int/\\_\\_data/assets/pdf\\_file/0005/112199/E79097.pdf](http://www.euro.who.int/__data/assets/pdf_file/0005/112199/E79097.pdf)).

Particles are deposited in the lungs by one of four different ways: interception, impaction, sedimentation, and diffusion. In general, particles having an aerodynamic diameter of greater than  $10 \mu\text{m}$  are deposited in the nasopharyngeal region (upper airway passages - nose, nasal cavity and throat) largely by impaction (see Figure 3). This mechanism is prominent because of the high air speed and the many turns in the nasopharyngeal airways. The changes in airflow direction cause many particles to hit the walls of the air passage and so the particles deposit or settle in this region (according to the specialists from the Canadian Centre for occupational Health and Safety and according A. D. Kappos, 2008).

Further, one concludes that smaller particles with an aerodynamic diameter of about  $0.003$  to  $5 \mu\text{m}$  are deposited in the trachea-bronchial and alveolar regions. Sedimentation is the most common way because at this point the air has slowed enough for particles to "settle" out. When the air gets to the alveolar region (the lower lung area), it has slowed even more. The air is essentially calm. Particulates that make it this far into the lungs are usually  $0.5 \mu\text{m}$  or smaller (according the Canadian Centre for occupational Health and Safety and A. D. Kappos, (2008)).

They enter the lung essentially by randomly landing on the membrane or other parts of the lung.

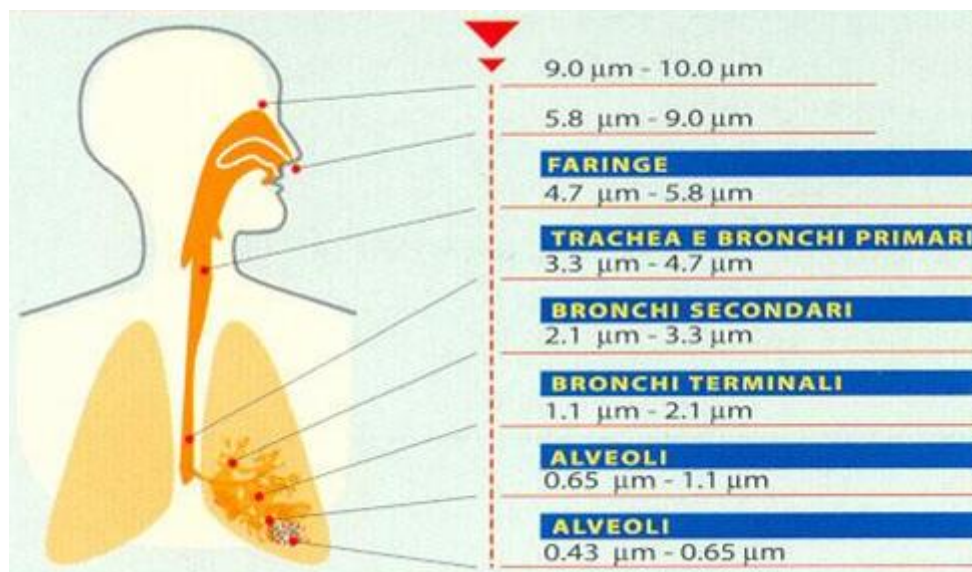

Figure 3. Level of pulmonary deposits according to particle size: Pharynx, Trachea and primary bronchi, Secondary bronchi, Terminal bronchi, Alveoli (Air Pollution Reduction Systemlife: A Possible Solution)

Traffic-related pollution is associated with the onset of asthma in children. Its effect on adult-onset asthma is poorly investigated. The study of N. Künzli et al. 2009, investigated associations between the 11-year change (1991-002) in home outdoor traffic-related particulate matter up to 10 µm in diameter (TPM<sub>10</sub>) and the incidence of asthma.

Each developed country launched a regulation for the maximum admitted levels of pollutants. Limiting PM pollution in the air protects human health and the environment for sure. In Romania, such regulation referring to PM has already been adopted and implemented (Law NO 104/2011), fully according to EU legislation (Directive 2008/50/CE from May, 21<sup>th</sup>, 2008). Moreover, the legislation indicates how often during a year the level can be exceeded (concerning the daily average).

One found evidence that residential exposure to traffic is associated with asthmatic and bronchitic symptoms, in particular with attacks of breathlessness, wheezing with breathing problems, wheezing without a cold, and regular phlegm. The findings in a random sample of the adult population of Switzerland provide further support to the hypothesis that traffic exhausts are relevant to respiratory health (<http://ephtracking.cdc.gov/showAirHIA.action>). Also, one found a tendency for stronger respiratory effects in never smokers and in men. L Bayer-Oglesby et al. 2006 concluded that living close to main streets or in a dense street network increases the risks for certain respiratory symptoms in adults, particularly for asthma-related symptoms such as attacks of breathlessness and wheezing and for bronchitic symptoms such as regular cough and phlegm.

Ch Schindler et al. 2009, indicate that reductions in ambient particle concentrations may have beneficial effects on the respiratory health of adults within few years even in areas with moderate to low levels of air pollution. Moreover, they suggest that efforts to reduce particulate pollution should be sustained irrespective of improvements already achieved, as the potential for reversibility of symptoms was even higher at lower initial exposure levels.

Under these conditions, perspective filtering systems (for outdoor use) were developed. They are expected to ensure control over air quality in areas primarily affected by pollution problems. The Filtering System in fact works like a technological lung, inhaling polluted air and exhaling filtered air. Inside the station there are four complementary filtering stages. An example of a filtering possibility in open air conditions is the Systemlife innovative filter system, enabling city air to be purified within a working range of 350 m and covering a surface area of about 400,000 m<sup>2</sup>. Thanks to an advanced



technology filter system, the Systemlife Filter Station draws in the polluted air continuously, retaining the fine dust, pollutants and smells and returning the clean air to the atmosphere (see <http://www.systemlife.ro/Eng/systemlife.php>). The filtration station sucks in polluted air continuously, retains fine dust particles, pollutants and odours and returns clean air into the atmosphere, due to an automatic control panel (*Climate Box*). It works in four filtering stages (Figure 4), the filtering efficiency being guaranteed by an automatic filter washing process. The influence of a Filtering Station covers distances of 320/350 m and a surface area of about 150,000-250,000 m<sup>2</sup>, purifying about 200,000 m<sup>3</sup> of air per day (operating 20 hours/day), thus contributing to the reduction of the PM pollution level.

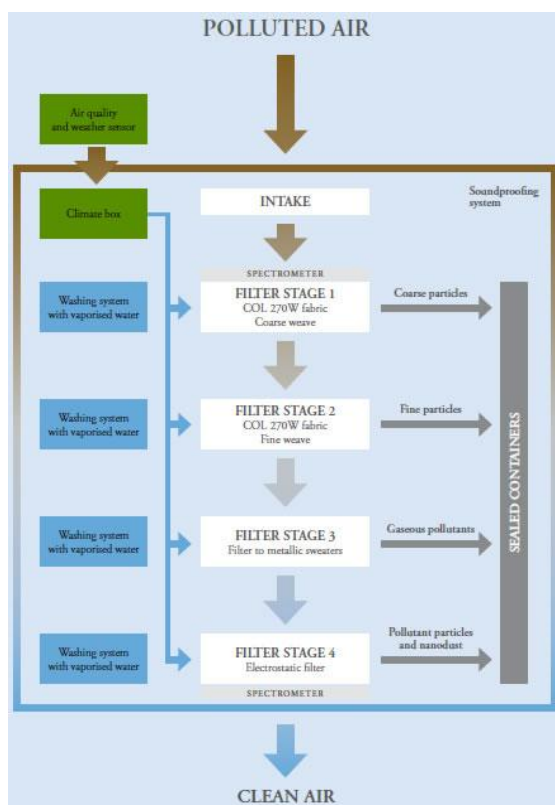

Figure 4. Stage filtering system of the Systemlife Filtering System (<http://www.systemlife.ro/Eng/systemlife.php>)

The case study was planned under the circumstances of infringement planning from the EC to the city, as the maximum admitted values exceeded the standard accepted number.

Table 1 presents the number of exceeding events concerning the PM threshold value of 50 µg/m<sup>3</sup>.

Table 1: The number of exceeding for the PM<sub>10</sub> concentrations, reported officially by the environmental measuring stations in the city.

Year	TM1 environmental measuring station (Calea Sagului)	TM5 environmental measuring station (Calea Torontalului)	No. of exceeding per year
2010	51	40	91
2011	64	56	120
2012	14	24	38
2013	7	23	30
2014	5	28	33
2015	19	22	41

## METHODOLOGY

Two measuring techniques were used: *gravimetry* (as a standard method) with an LSV3 impactor, and *laser spectrometry* (having a major advantage of depicting much more dimensions and working continuously). Two episodes were analyzed: 1) the filtering system was functional, 2) the system was not in function. The location selected for the filtering system was in the historical area of Timisoara (Sf Gheorghe Square).

In the EC one has to apply the standard method indicated by the document EN 12341:2014 (Ambient air – Standard applying the gravimetric measurement method - GMM), which supersedes EN 12341:1998 and EN 14907:2005. This European Standard describes a standard method for determining the PM<sub>10</sub> or PM<sub>2.5</sub> mass concentrations of suspended particulate matter in ambient air by sampling the particulate matter on filters and weighing them by means of a balance. Measurements are performed with samplers with inlet designs, operating at a nominal flow rate of 2.3 m<sup>3</sup>/h, over a nominal sampling period of 24 h. Measurement results are expressed in µg/m<sup>3</sup>, where the volume of air is the volume at ambient conditions near the inlet at the time of sampling. This standard is offering a method which is chosen, in comparison to for example the β-ray absorption method (BAM). S. E. Shin et al. (2011) measured the mass concentrations of particulate matter less than 10 µm in size (PM<sub>10</sub>) by BAM and GMM and have shown consistent difference, not very clearly explained.

Thus, for comparison of the measured values, the GRIMM instrument, working according spectrometry, (according to the model M\_E\_IAQ\_1108-1109-Spec\_v2p4, Portable Laser Aerosolspectrometer and Dust Monitor Model, GRIMM 1.108/1.109) was selected. It is an optical dust mass measuring systems for PM<sub>10</sub> and PM<sub>2.5</sub>, measuring not only the dust mass in real-time, but also the particle sizes and their distribution in different size ranges, simultaneously. The standard fractions of interest are: (1) Inhalable fraction – the mass fraction of total airborne particles which is inhaled through the nose and mouth, (2) Thoracic fraction – the mass fraction of inhaled particles penetrating beyond the larynx, (3) Respirable fraction – the mass fraction of inhaled particles penetrating to the unciliated airways.

## RESULTS AND DISCUSSIONS

Figure 5 indicates the comparison between the results for the PM<sub>10</sub> concentrations measured with both systems, under two conditions: with functional and non-functional Filtering system.

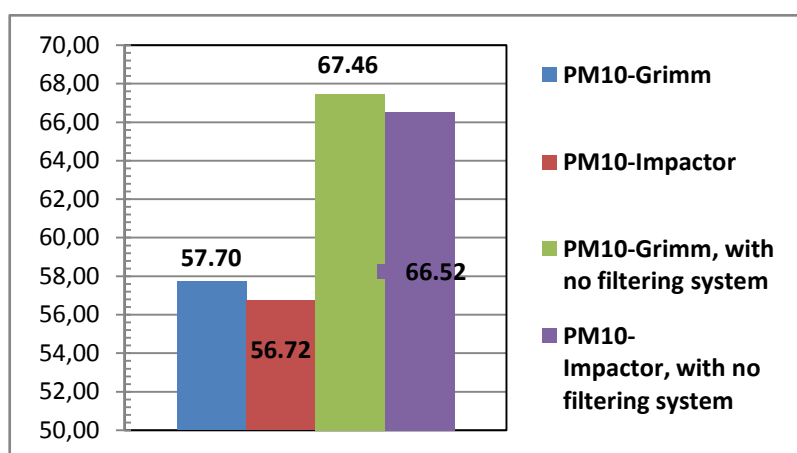

Figure 5. Comparison of the results for the PM concentrations, expressed in µg/m<sup>3</sup>, determined with standard (LSV3 impactor) and accepted spectrometer (GRIMM), for both episodes (with and without filtering system in function).

The different maximum levels indicated are all over the threshold. But still, when the filter is active, the values are less smoothly. Also, the distance (even small) between the locations of the two instruments, together with the level at which they sucked the air for analysis, were smoothly different.

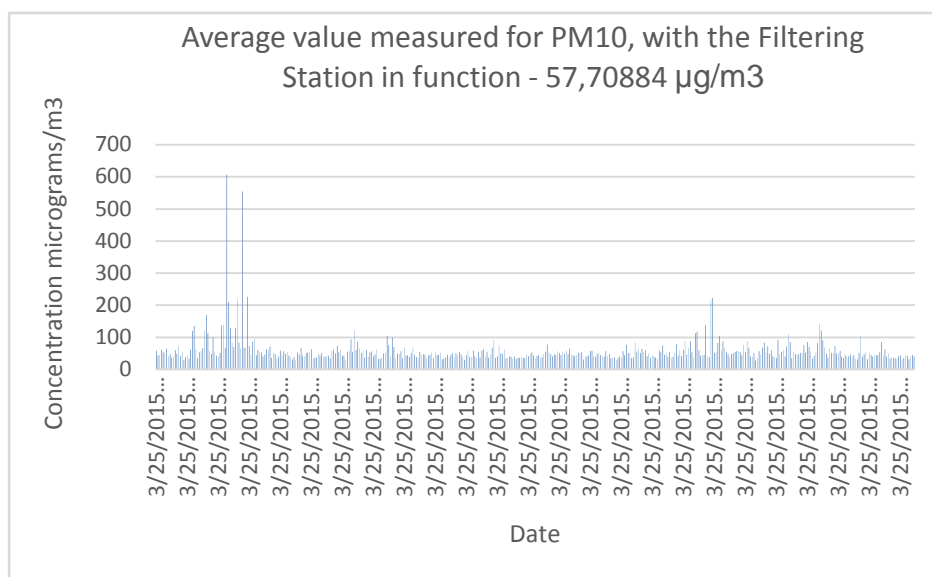

Figure 6. Average value for the  $PM_{10}$  concentrations, measured during the episode when the filtering station was functional.

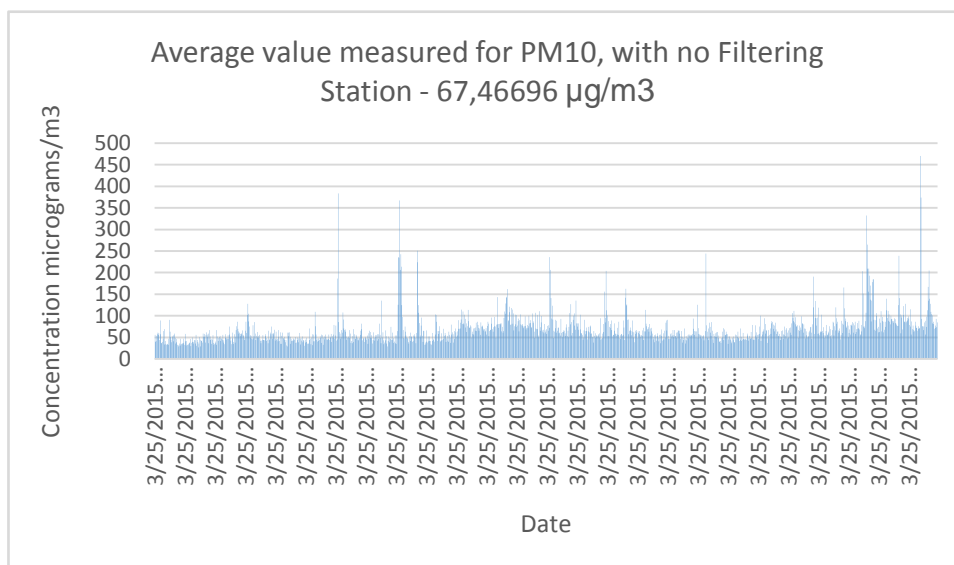

Figure 7. Average value for the  $PM_{10}$  concentrations, measured during the episode when the filtering station was not functional.

The average value of the  $PM_{10}$  concentrations for the investigated period is less in the case of the functioning of the filtering system (see Figures 6 and 7).

The filtering station is more active for coarse particles ( $PM_{10}$ ), but best for the very small ones (Inhalable, thoracic), and less sensible to alveoli,  $PM_{2.5}$  and  $PM_1$  (Figure 8). The explanation can be depicted in the integrated filtering system that presents also an electrostatic stage, which works differently for smaller or larger particles.

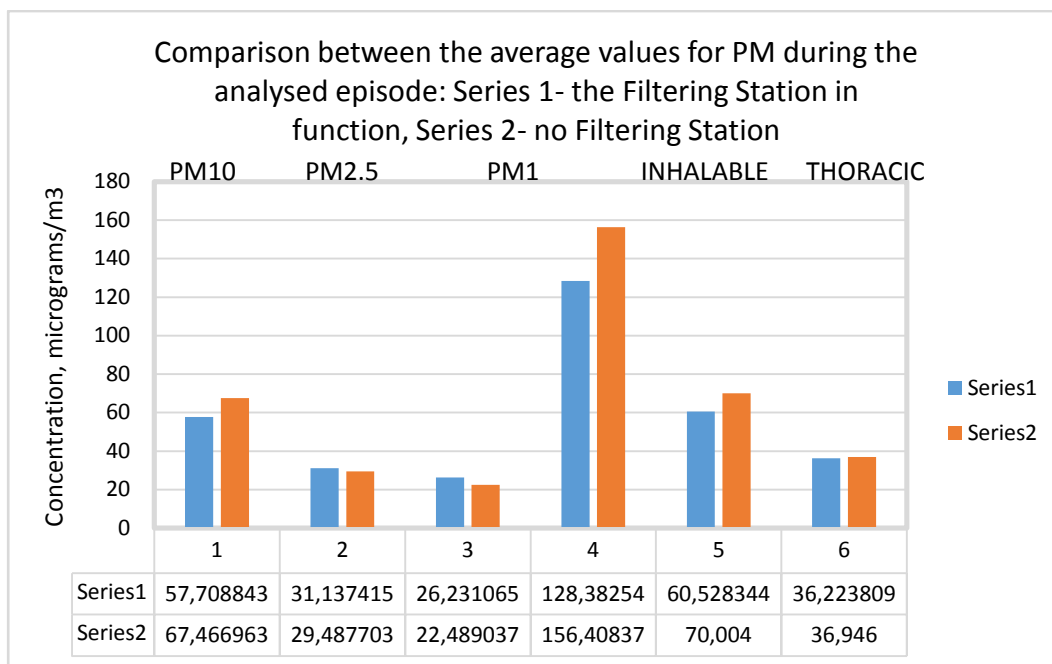

Figure 8. Comparison of the two episodes for similar particle sizes.

## CONCLUSIONS

The open air filtering systems are a novel technology. The research concerning their efficiency in removing the particles from a central city region was presented. One determined that the system can reduce the concentrations of very small particles, which are the most dangerous for human being. Nevertheless, the place where the systems are mounted must be carefully selected and planned, as the influence of the cleaning process is limited. Measuring the PM species by different technical options (methods) can conclude to more detailed results. Further research for measuring and filtering the very small sized particles is necessary.

## ACKNOWLEDGEMENT

The research presented was generated as a result of the Contract 119/29.04.2015 financed by the Timisoara Municipality, based on the dissemination program in the frame of the projects BanatAir (Sustainable development for Banat region by means of education and scientific research & development in transboundary air quality monitoring issues, cod 385 MIS-ETC <http://banatair.mec.upt.ro>, project financed by the IPA CBC Programme Romania Serbia) and TransAirCulture Contract (Contribution to sustainable development by assessing the transboundary air pollution upon the cultural/turistical heritage in HU-RO border, financed by the Hu-Ro Cross-Border Cooperation Programme 2007-2013, ID HURO/1001/139/1.3.4, <http://mec.upt.ro/transaircultor/>). It is partially supported also by ACTRIS2, a Research Infrastructure project, funded by the European Union's Horizon 2020 research and innovation programme, under the grant agreement No. 654169 and previously under FP7 grant agreement No. 262254.

## LITERATURE

- \*\*\*, EPA, <https://www3.epa.gov/region1/airquality/pm-what-is.html>
- Evaluating Exposures to Toxic Air Pollutants: A Citizen's Guide, Originally published as EPA 450/3-90-023, March 1991 <https://airnow.gov/index.cfm?action=aqibasics.particle>, accessed September 2016
- \*\*\*, EPA, [https://www.epa.gov/sites/production/files/2016-09/pm2.5\\_scale\\_graphic-color\\_2.jpg](https://www.epa.gov/sites/production/files/2016-09/pm2.5_scale_graphic-color_2.jpg), accessed September 2016
- \*\*\*, EPA, <https://www3.epa.gov/airnow/particle/pm-color.pdf>, accessed September 2016

- \*\*\*, World Health Organization 2013, Policy implications for countries in Eastern Europe, Caucasus and central Asia, ([http://www.euro.who.int/\\_\\_data/assets/pdf\\_file/0006/189051/Health-effects-of-particulate-matter-final-Eng.pdf](http://www.euro.who.int/__data/assets/pdf_file/0006/189051/Health-effects-of-particulate-matter-final-Eng.pdf), accessed September 2016
- I. Ionel, S. Mochizuki, O. Comsa, D. Lelea, (2010), Three dimensional numerical simulation of the reciprocating flow in a branching tube network, *Heat and Mass transfer*, 46-903-910, doi 10.1007/s00231-010-0638-y, p. 903-905
- \*\*\*, WHO Working group, Health Aspects of Air Pollution with Particulate Matter, Ozone and Nitrogen Dioxide, Report on a WHO Working Group Bonn, Germany 13–15 January 2003, [http://www.euro.who.int/\\_\\_data/assets/pdf\\_file/0005/112199/E79097.pdf](http://www.euro.who.int/__data/assets/pdf_file/0005/112199/E79097.pdf)
- \*\*\*, Canadian Centre for occupational Health and Safety, [https://www.ccohs.ca/oshanswers/chemicals/how\\_do.html](https://www.ccohs.ca/oshanswers/chemicals/how_do.html), accessed September 2016
- A. D. Kappos, P. Bruckmann, Th. Eikmann, N. Englert, U. Heinrich, P. Höpfe, E. Koch, G. H.M. Krause, W. G. Kreyling, K. Rauchfuss, P. Rombout, V. Schulz-Klemp, W.R. Thiel, H.-E. Wichmann, (2004), Health effects of particles in ambient air, *International Journal of Hygiene and Environmental Health*, Volume 207, Issue 4, Pages 399-407
- \*\*\*, <http://ephtracking.cdc.gov/showAirHIA.action>
- \*\*\*, Air Pollution Reduction Systemlife: A Possible Solution, <http://www.systemlife.ro/Teste%20si%20Certificari/DOC.4%2023236-gb-risposta%20all'inq.%20atmos.%20inglese.pdf>
- N. Künzli, P.-O. Bridevaux, L.-J. S. Liu, R. Garcia-Esteban, C. Schindler, M. W. Gerbase, J. Sunyer, D. Keidel, T. Rochat, (2009), Traffic-related air pollution correlates with adult-onset asthma among never-smokers, *Thorax*;64:664-670 doi:10.1136/thx.2008.110031.
- L. Bayer-Oglesby, Ch. Schindler, M. E. Hazenkamp-von Arx1, Ch. Braun-Fahrlander, D. Keidel, R. Rapp, N. Kunzli, O. Braendli, L. Burdet, L.-J. Sally Liu1, Philippe Leuenberger, Ursula Ackermann-Liebrich, (2006), *American Journal of Epidemiology*, DOI: 10.1093/aje/kwj338, October 10, p. 1-9
- Ch. Schindler, D. Keidel, M.W. Gerbase, E. Zemp, R. Bettschart, O. Brndli, M. H. Brutsche, L. Burdet, W. Karrer, B. Knopfli, M. Pons, R. Rapp, L. Bayer-Oglesby, N. Knzli, J. Schwartz, Lee-J. S. Liu, U. Ackermann-Liebrich, Th. Rochat, and the SAPALDIA Team, (2009), *Improvements in PM10 Exposure and Reduced Rates of Respiratory Symptoms in a Cohort of Swiss Adults (SAPALDIA)*, *Am J Respir Crit Care Med*. Vol 179. pp 579–587,
- \*\*\*, <http://www.systemlife.ro/Eng/systemlife.php>, accessed by September 2016-09-24
- S. E. Shin, Ch. H Jung, Y. P. Kim, Analysis of the Measurement Difference for the PM10 Concentrations between Beta-ray Absorption and Gravimetric Methods at Gosan, Aerosol and Air Quality Research, 11: 846–853, print / 2071-1409 online doi: 10.4209/aaqr.2011.04.0041
- \*\*\*, M\_E\_IAQ\_1108-1109-Spec\_v2p4, Portable Laser Aerosolspectrometer and Dust Monitor Model, GRIMM 1.108/1.109, <http://www.grimm-aerosol.com/>, accessed September 2016-09-24

V International Conference  
„ECOLOGY OF URBAN AREAS“ 2016

**ANALYZING THE LEVEL OF HIGH TROPOSPHERIC OZONE  
DURING THE SUMMER 2013 IN SKOPJE, R. MACEDONIA**

**Bobi Stoimenovski, Kosta Mitreski, Andreja Naumoski, Danco Davcev**

Ss. Cyril and Methodius University in Skopje,  
Faculty of Computer Science and Engineering, Skopje, Macedonia  
bbstoimenovski@gmail.com; {kosta.mitreski\*, andreja.naumoski, danco.davcev}@finki.ukim.mk

**ABSTRACT**

*Ozone is a health-hazardous air pollutant and its level is increased with increasing of the air temperature. In this paper, we have analyzed the summer period from 01.06.2013 to 30.09.2013 in Skopje, R. Macedonia. The influence of the environmental parameters to the ozone level was determined by applying the decision trees. The main objective of this research is to determine the threshold temperature value(s) for which the high ozone values will exceed the limit values. According to different types of decision trees, we found the temperature thresholds of 30.15°C, which resulted in the highest ozone levels.*

**Key words:** *threshold ozone, decision tree, environmental parameters, troposphere.*

**INTRODUCTION**

We have all heard about the ozone layer, located at an altitude of 25-30 kilometres and a width of 20 kilometres that protects us from harmful UV radiation of the Sun, thus protecting life on Earth. This is called "Good ozone layer". However, ground-level ozone (Ozone located in the troposphere) or the so-called "Bad ozone layer" occurs as a byproduct of certain human activities across the globe. Ozone is the only pollutant of nature that is not obtained directly from the source of pollution, but as a result of interaction of nitrogen oxides, volatile organic compounds and meteorological conditions.

The growing number of residents, the majority of vehicles, new industrial plants, global warming is one of the reasons for increased amounts of ozone in the troposphere. Unlike most other air pollutants, ozone is not emitted directly into the air from a source. Ozone is formed by the interaction with the sun[6], particularly ultraviolet light, carbon and nitrogen oxides emitted from vehicles, power plants using fossil fuels, refineries and other industries.

While the ozone in the stratosphere, it protects us from UV radiation, but in the troposphere regarding the environment this pollutant causes adverse effects on growth and reproduction of plants, reduces agricultural yields, affects the ecosystems through changes in water movement, the cycle of minerals / nutrients, habitats, causes disintegration of organic materials, affects the destruction of nylon, rubber and other materials, hurts or destroys animal tissue and it is especially hazardous for people who work outdoors or have respiratory problems.

When ground-level ozone reaches high levels, people should be informed to take extra precautions because respiratory tissue might be damaged, as well as gum tissue, causing damaging cells through oxidation, etc. This can affect the performance of athletes, the occurrence of frequent asthma attacks, irritation of the eyes, chest pain, coughing, vomiting, headaches, exacerbated heart disease, bronchitis and emphysema[13].

Despite the evidence of the harmful effects of increased concentration of ground-level ozone has on humans and vegetation, there is constant growth of this pollutant in the EU, US and in other parts of the world[4]. The World Health Organisation[14] emphasises the risk from elevated concentrations of ozone on human health and vegetation and gives instructions for setting the limit value of 100µg/m<sup>3</sup> eight-hour daily ozone concentration, although the EU regulation is still with limit value of 120µg/m<sup>3</sup>.

It should be noted that there is no 100% safe threshold level and some individuals may be at risk with limit values less than the recommended ones [1,2,3].

Similar research is being done in R. Slovenia for the town Ljubljana [15] but we would like to extend our research for the town Skopje with more measurements data and more pollution parameters.

## **DATA AND METHODOLOGY**

To study the effect and the ratio of meteorological and environmental parameters data mining methods were used. For this purpose a reliable statistical database of meteorological and environmental parameters was created.

We focus our research for one of the Municipalities in Skopje, the Karposh Municipality because according to the information published on their Web, they reported "exceeding 8 hours of ground-level ozone" [10, 11, 12].

At higher temperatures there are higher ozone values, such that our goal will be to determine the threshold temperature value at which ground-level ozone exceeds the limit values set by the 2002/3/EC Directive. The value of ground-level ozone according to this directive is set to  $120\mu\text{g} / \text{m}^3$  eight-hour maximum that may be overcome no more than 25 times a year. The average value when the public must be immediately informed is overcoming  $180\mu\text{g}/\text{m}^3$ , while the alert threshold is at  $240\mu\text{g}/\text{m}^3$ .

With proper ranking of the considered parameters of the primary pollutants that participate in the creation of ozone, it is possible to identify specific emitters of primary pollutants that initiate the creation of ground-level ozone. Yet the most important contribution of this paper is the possibility to alert the population of most affordable meteorological parameter - the temperature, for possible high concentrations of ozone. This information can be very useful for the risk group of people that will know the temperature at which to apply the advice of doctors. The institutions should be informed in alarm situations when there is increase of air pollution in urban areas and the need for reduction and regulation of emissions in order to obtain better air quality.

The database is consisted of parameters such as ozone, carbon monoxide and nitrogen dioxide, taken from the database of the Ministry of Environment and Spatial Planning of the Republic of Macedonia from the measurement station of Karposh in the period from 01.03.2013 to 31.12.2013. The database also contains parameters such as temperature humidity and pressure, taken from the database of Hydrometeorological Office in the Republic of Macedonia taken from the base station "Rabbit Hill" in the period from 01.03.2013 to 31.12.2013. All data taken from these databases are numerical. The database is composed of hourly data in the given time period. 43.185 processed data means that only less than 2% are missing from total of 44.064 data. Later on, the analysis is limited to the summer months (June, July, August and September) and 17.223 data from the total of 17.568 data have been processed in this period, retaining the trend of lack of less than 2% of total data. All data was previously processed to meet the demands of selected open source software for data search – WEKA[5].

## **RESULTS AND DISCUSSION**

The initial examination was conducted with LeastMedSq to establish whether ozone data is linear temperature-dependent or not. However, according to the results we believe that the relationship is nonlinear. In order to determine what is the impact of the other attributes to the ozone, we rank attributes according to the attribute appraiser in WEKA, RreliefFAttributeEval. He implements the instance-based RReliefF method [8] to assessing the relevance of attributes. We use 10-fold cross-validation to calculate the relevance of a multitude of functions and their differences. Ranking of the yearly database parameters is presented in Table 1.

Table1: - Ranking of the attributes with RReliefF in correlation with their relevance for prediction of the ozone concentration in the period from 01.03.2013 to 31.12.2013.

Rank	1	2	3	4	5
Parameters	Pressure	Humidity	Temperature	CO	NO2

In Table2 the ranking of the parameters from 01.06.2013 to 30.09.2013 is given.

Table2 : Ranking of the attributes with RReliefF in correlation with their relevance for prediction of ozone concentration in the period from 01.06.2013 to 30.09.2013

Rank	1	2	3	4	5
Parameters	NO2	Temperature	Pressure	CO	Humidity

Comparing the two tables we can see that nitrogen oxide and temperature have a higher rating in terms of rating of parameters throughout the year. The reason for this is the interaction between NO2 and UV radiation in the formation of ozone. The atmospheric chemistry of ground-level ozone creation is shown on Figure 1.

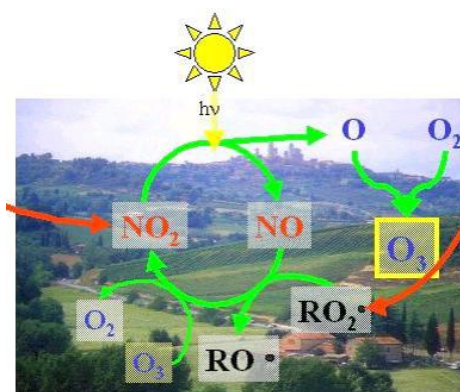

Figure 1: Ground storm chemistry of ground-level ozone [16]

WEKA enables us the availability and distribution of all attributes. They are illustrated on the figures below.

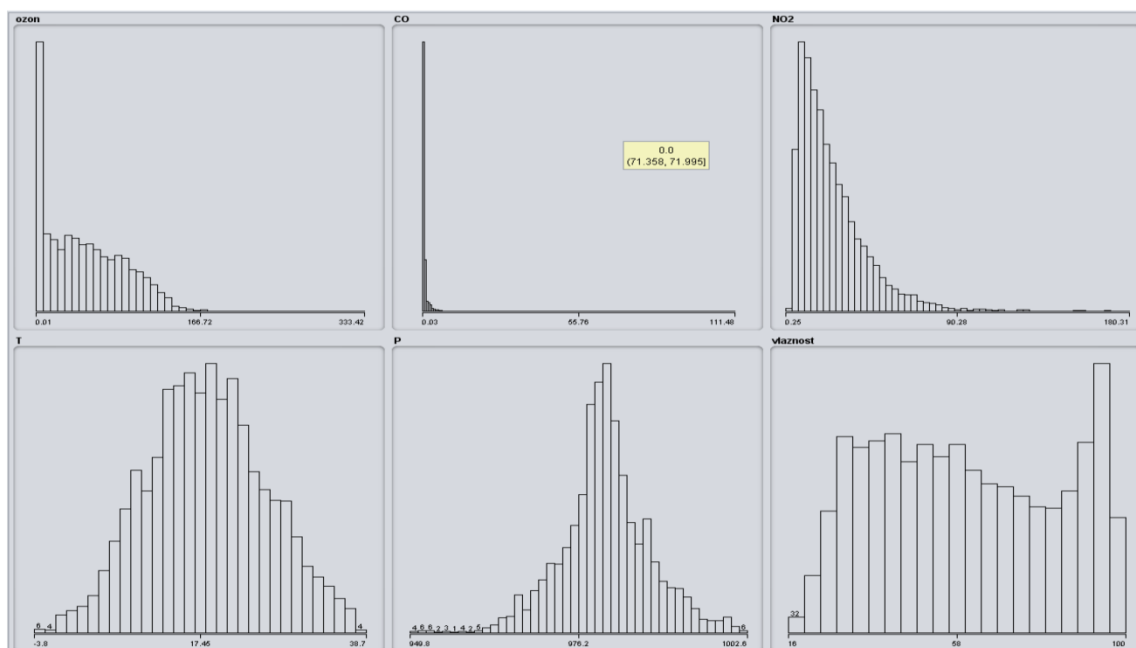

Figure 2: Distribution of attribute value into data in the period from 01.03.2013 to 31.12.2013



Availability and distribution of all attributes in the period from 01.06.2013 to 30.09.2013 is shown in Figure 3.

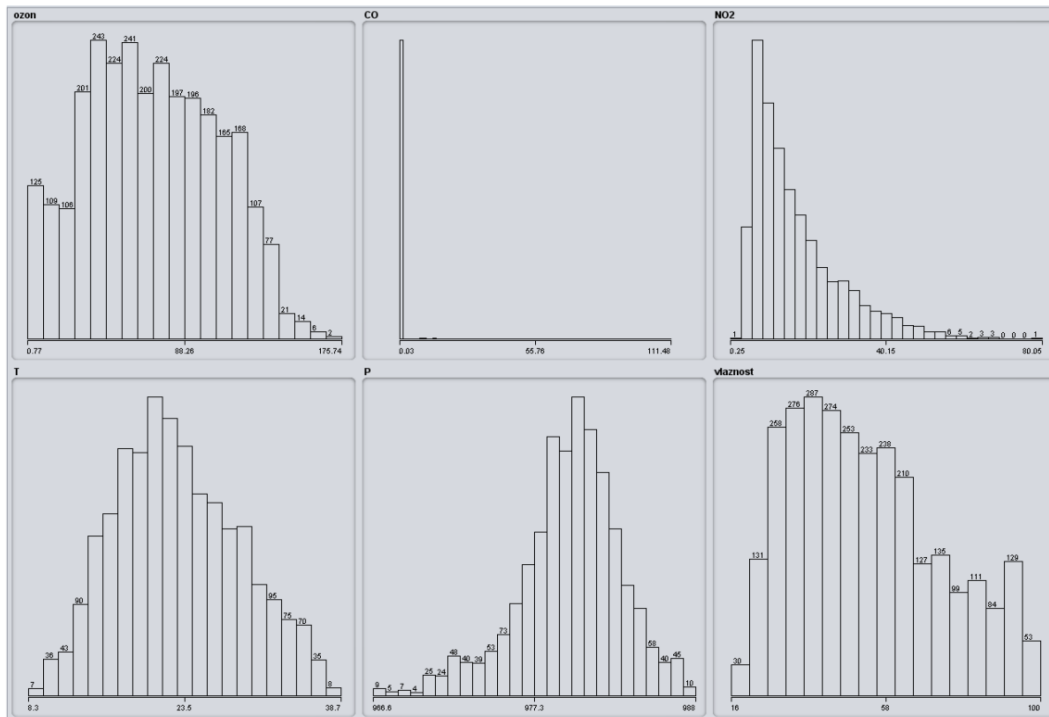

Figure3: Distribution of attribute values into data in the period from 01.06.13 to 30.9.13

For the decision tree we used the model tree (MT). This tree was built by using the M5R algorithm [7] in the WEKA package for data mining. Because of the dependence of the creation of ozone from the high temperatures we will adjust the decision tree to the period from 01.06.2013 to 30.09.2013.

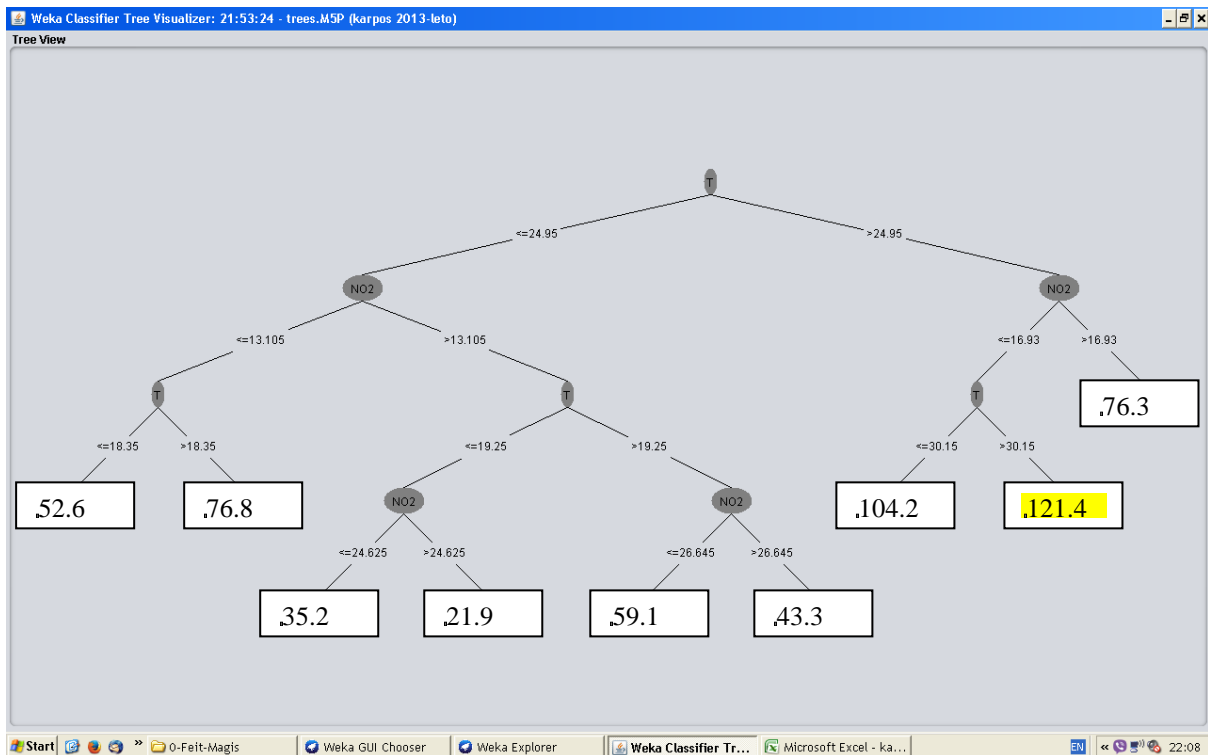

Figure 4: Model tree with all parameters

The rules leading to the prediction of high ozone values are: IF NO<sub>2</sub><16.03 AND IF Temp>30.15 THEN O<sub>3</sub>=121.4. We get a correlation coefficient>0.8 for the model tree. We found a threshold temperature at 30.15 which leads to higher ozone values.

## CONCLUSION

Ozone is a health-hazardous air pollutant and its level is increased with increasing of the air temperature. In this paper, we have analyzed the summer period of 2013 in Skopje, R. Macedonia. The M5P algorithm was used to analyze the data by creating decision tree, helping us to find threshold values which determine high ozone concentrations.

The main objective of this research is determination of the threshold temperature value(s) for which the high ozone values will exceed the limit values. According to different types of decision trees, we found the temperature thresholds of 30.15°C, which resulted in the highest ozone levels.

## ACKNOWLEDGMENTS

This work was supported (by using their data bases) from the Hydro- meteorological Institute-Skopje and the Ministry of Environment and Spatial Planning of the Republic of Macedonia. It was partially financed by the Faculty of Computer Science and Engineering, Skopje, R. Macedonia

## REFERENCES

- [1] EC. *Council Directive 96/62/EC of 27 September 1996 on ambient air quality assessment and management*. Retrieved from: <http://eur-lex.europa.eu/legalcontent/EN/TXT/?uri=CELEX:31996L0062>.
- [2] EC. *Directive 2002/3/EC of the European Parliament and of the Council of 12 February 2002 relating to Ozone in ambient air*. OJL 67, 3 March 2002. Retrieved from: <http://eur-lex.europa.eu/legalcontent/EN/TXT/?uri=celex:32002L0003>
- [3] EC. *Directive 2008/50/EC of the European Parliament and of the Council of 21 May 2008 on ambient air quality and cleaner air for Europe*. Retrieved from: <http://eurlex.europa.eu/legalcontent/EN/TXT/?uri=CELEX:32008L0050>.
- [4] European environment agency (EEA). 2012. *Air quality in Europe — 2012 report*. EEA Report No 4/2012, Copenhagen.
- [5] Hall, M., Frank, E., Holmes, G., Pfahringer, B., Reutemann, P., and Witten, I. 2009. The WEKA Data Mining Software: An Update. *SIGKDD Explorations*, 11, 1: 10–8.
- [6] Lee, J.D., Lewis, A.C., Monks, P.S., et al. 2006. Ozone photochemistry and elevated isoprene during the UK heatwave of August 2003. *Atmos. Environ.* 40, (Dec. 2006), 7598–7613. DOI= doi:10.1016/j.atmosenv.2006.06.057.
- [7] Quinlan, R.J. 1992. Learning with Continuous Classes. In: *Proceedings of the 5th Australian Joint Conference on Artificial Intelligence*. World Scientific, Singapore, 343–348.
- [8] Robnik-Sikonja, M., and Kononenko, I. 2003. Theoretical and Empirical Analysis of ReliefF and RReliefF. *Mach. Learn.* 53, (Oct. 2003), 23–69.
- [9] Salvato, J., A., Nemerow, N., and Agardy, F., J. 2003. *Environmental engineering*. Fifth edition. John Wiley & Sons: New Jersey.
- [10] Ministry of Environment and Spatial Planning of the Republic of Macedonia, 2013, [http://airquality.moep.gov.mk/?page\\_id=1505](http://airquality.moep.gov.mk/?page_id=1505)
- [11] Hydrometeorological Office in Skopje, 2013, <http://www.meteo.gov.mk/>
- [12] National Hydrometeorological Service – R. Macedonia, 2013, Bazina meteoroloskipodatoci, [http://www.meteo.gov.mk/index.php?option=com\\_content&view=category&id=30&Itemid=59&lang=mk](http://www.meteo.gov.mk/index.php?option=com_content&view=category&id=30&Itemid=59&lang=mk)
- [13] Williams, S., Nitschke, M., Weinstein, P., Pisaniello, D.L., Parton, K.A., and Bi, P. 2012. The impact of summertemperatures and heatwaves on mortality and morbidity in Perth, Australia 1994 –2008. *Environ. Int.* 40 (Apr 2012), 33–38. DOI= doi:10.1016/j.envint.2011.11.011.
- [14] World Health Organization (WHO). 2006. *Air quality guidelines for particulate matter, Ozone, nitrogen dioxide and sulfur dioxide. Global update 2005. Summary of risk assessment*. WHO, Geneva.
- [15] Johanna A. Robinson, Sašo Džeroski, David Kocman, Milena Horvat “Analyzing the formation of high tropospheric Ozone during the 2015 heatwaves in Ljubljana with data mining” Proceedings of the 18th International Multiconference, INFORMATION SOCIETY – IS 2015, Volume A, pp.96–99.
- [16] Tropospheric ozone, (2011), Prof. Dr. Ivan Grzhetik, Chemical Engineering- Beograd.

V International Conference  
„ECOLOGY OF URBAN AREAS“ 2016

**EMISSION DISPERSION MODELLING OF A COAL FIRED 420 T/H  
STEAM BOILER IN A COAL/BIO MASS CO-FIRING SCENARIO. AIR  
QUALITY ASSESSMENT**

**Francisc Popescu<sup>(1,3)</sup>, Bogdana Vujic<sup>(2)</sup>, Milan Pavlovic<sup>(2)</sup>, Adrian Eugen Cioabla<sup>(1)\*</sup>,  
Aleksandar Djuric<sup>(2)</sup>, Adrian Tenchea<sup>(4)</sup>**

<sup>(1)</sup> University Politehnica Timisoara, Faculty of Mechanical Engineering, Romania

<sup>(2)</sup> Technical Faculty “Mihajlo Pupin” Zrenjanin, Serbia

<sup>(3)</sup> EcoAge Engineering, Romania

<sup>(4)</sup> Timisoara Regional Directorate of Legal Metrology, Romania

francisc.popescu@upt.ro

**ABSTRACT**

*The paper will present a possible scenario of improvement of air quality by using biomass as co-fuel in a coal fueled power plant. The case scenario will focus on the most used steam boiler in Romanian energy sector, the 420 t/h steam boiler. A case study of the advantages on using biomass co-firing in an existing coal (lignite) fired boiler is presented, with an emphasis on local and regional air quality improvement.*

**Key words:** ADMS5, stack emissions, air quality, biomass, co-firing.

**INTRODUCTION**

Atmospheric pollution is a major problem facing all nations of the world. Rapid urban and industrial growth has resulted in vast quantities of potentially harmful waste products being released into the atmosphere. The atmosphere is the largest imaginable chemical reactor in which pollutants may be converted into more harmful or harmless substances. Societies have been reserved to accept, or have simply failed to recognize the limitations of the cleaning properties of the atmosphere and self-adaptation of the ecosystem Planet, with no remnant damages or preventing a non-equilibrium status. The consequences has been that air pollution has affected the health and wellbeing of people, has caused widespread damage to vegetation, crops, wildlife, materials, buildings and climate, and has resulted in depletion of the scarce natural resources needed for long-term economic development..

The four major groups of gaseous air pollutants by historical importance, concentration, and overall effects on plants and animals (including people), are Sulphur dioxide (SO<sub>2</sub>), oxides of nitrogen (NO<sub>x</sub>: NO, NO<sub>2</sub>), Carbon dioxide (CO<sub>2</sub>) and ozone (O<sub>3</sub>). Sulphur dioxide (SO<sub>2</sub>) and nitric oxide (NO) are primary pollutants – they are emitted directly from sources. There are numerous methods to reduce and control this pollutants, directly at the source, easily available technologies, however, at significant economic impact, especially in developing countries like Romania or Serbia. The use of available technologies, low-NO<sub>x</sub> burners with controlled air-fuel rations and staged combustion, selective catalytic reduction (SCRs) or selective non-catalytic reduction (SNCR), desulphurization units (mainly limestone based like SDA - spray-dryer absorber scrubbers) is facile but extremely expensive. This is the reason why in Romania none of the coal power plants are fitted with such technologies. Exceptions exists, but on the entire power plant, only applied at one stack (usually with 2 to 3 boilers)

A possibility to reduce both SO<sub>2</sub> and CO<sub>2</sub> emissions would be to use the biomass conferring technologies, as it would involve insignificant modification to existing Romanian coal power plants – as all of the major Romanian boilers already use the fluidized bed combustion technology. Biomass cofiring is an opportunity for consumers and power companies. Recent polls found that consumers are willing to support renewable energy programs with a higher price for electricity made from renewable

sources. For power generators, biomass may represent the most plentiful and affordable supply of locally available renewable energy. (DOE/GO, 2000)

Cofiring biomass is particularly attractive to coal generators as this is one of the simplest ways of reducing net CO<sub>2</sub> emissions from a coal-fired power plant. However, due to the difference in fuel composition, several technical issues must be addressed when considering cofiring. Recent interest is focused on biomass cofiring at high cofiring ratios. This can exacerbate the effects of these operational issues and these must be assessed in detail to prevent damage to the plant or impair its operation. These issues may be of less importance if the power plant is approaching the end of its operating life. (Rohan, 2012)

The availability of biomass is especially important when considering cofiring at high ratios. It is essential that the biomass is cultivated sustainably. It must also not affect food production or tropical rain forests. Though an individual power plant may be able to reduce its CO<sub>2</sub> emissions substantially by cofiring at high ratios or total conversion to biomass, the availability of biomass will limit this as a universal option for CO<sub>2</sub> reduction. (Rohan, 2012) In Romania, biomass carries the highest potential for green energy production in the country, amounting around 88.33 TWh per year. It is estimated that approximatively 36% of this potential is currently used, but so far, biomass usage has mainly focused on household firewood: direct burning, space heating, cooking and water heating account for around 95% of the current biomass exploitation, while industrial biomass use equals only 5%. (Bujac, 2011)

#### AIR QUALITY COAL/BIOMASS CO-FIRING SCENARIO

In order to see the direct environmental impact of coal-biomass cofiring the following scenario was proposed - the power plant taken into consideration is RomagTermo (Halanga) power plant, located near the city of Drobeta Turnu-Severin. The following data were taken into account:

- The RomagTermo is equipped with 6 type CR1244 coal powered boiler, each producing 420 t/h of steam at 140 bar. The boilers are fitted 3 at one stack, with a total of two stacks at 243 meter and 280 meters. The steam is feeding four 50 MW generators, one of 25 MW and one of 22 MW;
- In this scenario two boilers at each stack were considered in function, at nominal rate;
- The average emission factors for NO<sub>x</sub> and SO<sub>2</sub> where based on authors direct measurements conducted in the past 10 years and are presented in table 1;
- The power plant has no NO<sub>x</sub> or SO<sub>2</sub> emission reduction/control facilities;

The meteorological data where considered for 5 different hours of the same day.

*Table 1: Emission factors included in the scenario*

No.	Stack	Emission factors for 100% coal [g/s]		Emission factors for coal-biomass ration of 70/30 [g/s SO <sub>2</sub> ]	Emission factors for coal-biomass ration of 50/50 [g/s SO <sub>2</sub> ]
		NO <sub>x</sub>	SO <sub>2</sub>		
1.	Stack 1 – boilers K1 + K2	71.02650	1871.3992	1309.979498	935.6996416
2.	Stack 2 – boilers K5 + K6	93.67761	1873.3769	1311.363879	936.6884852

The results obtained are presented in figures 1 and 2.

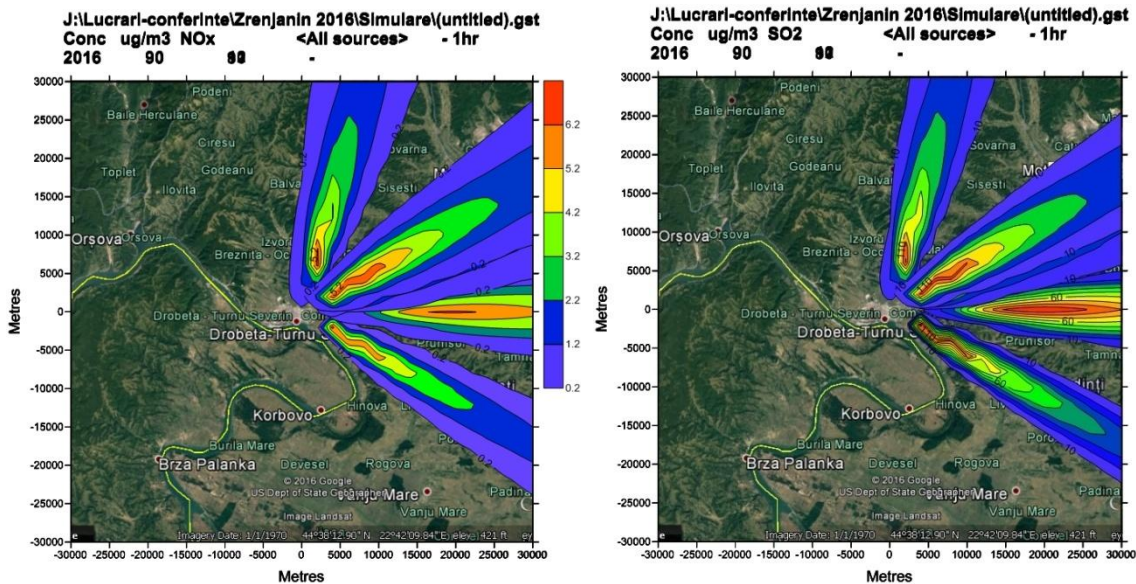

Figure 1. NO<sub>x</sub> and SO<sub>2</sub> dispersion for 100% coal combustion

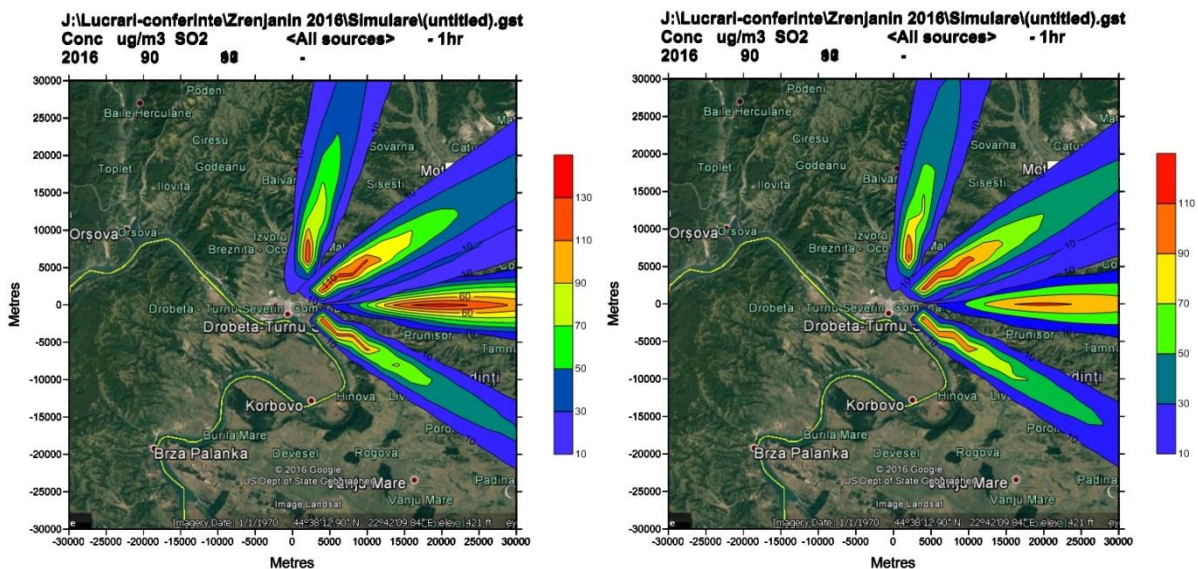

Figure 2. NO<sub>x</sub> and SO<sub>2</sub> dispersion for 100% coal combustion

## DISCUSSIONS AND CONCLUSIONS

In the dispersion maps produced by the considered scenario, at 30 and 50% biomass cofiring scenario one can observe that not only that the SO<sub>2</sub> concentration in ambient air are reduced with the expected ratios (from a maximum of ~160 μg/Nm<sup>3</sup> to ~140 μg/Nm<sup>3</sup> for 30% biomass and ~110 μg/Nm<sup>3</sup> for 50% biomass cofiring) but, more significantly one can notice the important reduction of the area affected by the pollution.

It is evident that the use of biomass cofiring in existing coal power plant will not reduce SO<sub>2</sub> emissions at levels accepted by EU and national regulation. However, it will significantly reduce the economic costs (due to size reduction) of needed desulphurization facilities.

It is widely considered that biomass firing and co-firing in large coal-fired power boilers, both in existing and new build plant, is a very attractive option for the utilization of biomass materials for power production, and for the delivery of renewable energy, in terms of the capital investment

requirement, the security of supply, the power generation efficiency and the generation cost. (Livingstone, 2016)

There are three main options to use the biomass for power production, in conventional steam cycle plants:

- The build-up of new, dedicated biomass power plants
- The cofiring of biomass in existing coal power plants – large pulverized bed boilers
- And the conversion of pulverized coal boilers to 100% biomass combustion

It is already known that the great majority of clean biomass materials of industrial importance have sulphur contents that are significantly lower than those in most coals and, in the great majority of cases, they also have similar or lower chlorine levels. The impact of biomass co-firing, therefore, in the great majority of cases is to reduce the acid gas abatement, and hence reduce the limestone usage and plant operating costs. The great majority of biomass materials also have significantly lower levels of most of the key trace element and heavy metal species than most coals, and the duties of the waste water treatment plants are reduced. This is not the case, of course, for a number of the biomass-based waste materials. (Livingstone, 2016)

However, the most important issues in case of biomass cofiring in coal power plants, are:

- The capital investment requirements of power plant conversion projects are very much lower than the investment costs of a new build power plant;
- The reliability and security of the supply of the power generated are higher than most other forms of renewable energy;
- The power generation efficiency and the generation costs are much better than those associated with industrial scale biomass power plants. (Livingstone, 2016)
- And, most importantly, the use on biomass cofiring will boost local and regional economy, as the biomass supply can only be local/regional

One implementation barrier of biomass-coal cofiring can be the fact that for large scale utility power generation projects, acquiring steady, year-round supplies of large quantity of biomass can be difficult. This is why special concern, involvement and development of dedicated national government programmes and long term plans are mandatory. Another biomass byproduct that could be used efficiently in large scale coal based boilers cofiring technology could be biogas with high methane percentage (over 70%) produced locally from regional landfill biodegradable wastes. (Cioabla, 2012)

## **ACKNOWLEDGMENT**

This work was supported by a grant of the Romanian National Authority for Scientific Research and Innovation, CNCS – UEFISCDI, project number PN-II-RU-TE-2014-4-1043.

## **REFERENCES**

- DOE, (2000). Biopower fact sheet – Biomass cofiring: A renewable Alternative for Utilities, U.S. Department of Energy (DOE), National Renewable Energy Laboratory, DOE/GO-102000-1055
- Rohan Fernando, (2012). Cofiring high ratios of biomass with coal, *Profiles*, no 12/2, IEA Clean Coal Centre
- Bujac Florin, (2011). Evaluating the potential of renewable energy sources in Romania, M.Sc. Program of Sustainable Energy Planning and Management Aalborg University, Denmark.
- Livingstone W.R, (2016). The status of large scale biomass firing. The milling and combustion of biomass materials in large pulverised coal boilers, ISBN 978-1-910154-26-7, IEA Bioenergy: Task 32

V International Conference  
„ECOLOGY OF URBAN AREAS“ 2016

**SIMULATION OF AIR POLLUTION DISPERSION FROM POINT SOURCES AND CROSS-BORDER IMPACT USING SIMULATION SOFTWARE ADMS 5**

**Aleksandar Đurić<sup>1\*</sup>, Bogdana Vujić<sup>2</sup>, Francisc Popescu<sup>3</sup>, Una Marčeta<sup>2</sup>, Miroslav Vulić<sup>2</sup>**

<sup>1</sup>Faculty of Technical Sciences, University of Novi Sad, Serbia

<sup>2</sup>Technical Faculty “Mihajlo Pupin”, University of Novi Sad, Serbia

<sup>3</sup>Faculty of Mechanical Engineering, University Politehnica Timisoara, Romania

\*alekszr@yahoo.com

**ABSTRACT**

*Air pollution is a serious problem, both for health and ecosystem biodiversity conservation. EU directives, national legal frame and current scientific knowledge impose to perform environmental impact studies for any significant investment (industrial facilities or constructions – e.g. roads). A significant part of any environmental study is focused on the investment impact on air quality. A fast and accurate tool to evaluate the pollutants dispersion into atmosphere is complex model to simulate the criteria pollutants propagation over a certain area of interest. As air pollution does not know boundaries, barriers or regions, the airborne pollutants dispersion in cross border areas is even more important as has potential to threaten wider communities or ecosystems. The purpose of using the software CERC ADMS 5 to simulate the dispersion of pollution aims to predict what happens to the pollutants and how they spread. In this paper a simulation scenario of air pollution dispersion from several of the largest point sources (power plants, chemical industry, etc) in the region of Vojvodina and Romanian Banat was conducted. The aim of the paper are to indicate the levels of pollution and areas under the cumulative influence of CO, SO<sub>2</sub> and PM.*

**Key words:** Air pollution, CERC ADMS 5, simulation, Cross-border impact.

**INTRODUCTION**

Air pollution, although it represent serious problem in which different toxic elements are made in process of combustion in the form of suspended particles with different diameters PM<sub>10</sub> and PM<sub>2.5</sub>, nitrogen oxide, sulfur oxide, is characterized by one important characteristic, and that is the fact that for air pollution country borders does not exist.

At the level of air pollution from various sources of pollution and the amount of their concentration is largely dependent on weather conditions. On the spreading of pollution may affect primary and secondary meteorological parameters [Rao, MN, H.V.N Rao, 2007]. Pollutants in the air, under of influence of metrological parameters in greater or lesser extent affect on air quality and environment from both sides of border. Purpose of making this work is to identify and evaluate over-border mutual influence of thermal power plants and industrial plants on both side of the border. With numerical modeling dispersion of pollutants it is possible to relatively accurately determine direct influence in quality of air and environment, identify critical and endangered areas and enable taking specific steps to alleviate these negative influences or eliminate them if that is necessary.

To a greater extent, when designing and constructing thermal power plants and industrial plants, locations are very good defined by tracking of long-term meteorological parameters. Climate change in the world, and therefore change of meteorological parameters lead us to the necessity that existing impacts of pollutants needed to be checked and verified. The developed dispersion software models allow that without long term following up on the terrain, in a relatively short period of time and on the basis of quality of input parameters to determine what is going on in a wide environment.

## MATERIAL AND METHODS

### Study area

Research conducted of pollutants dispersion in the atmosphere in work was done in Banat. Area of Banat is 28526 km<sup>2</sup> in size and includes areas of Serbia, Romania and Hungary. In Serbia, to Banat belong areas of North, South and Middle Banat. In Romania these are the areas of Timis, Karas – Severin, Mehedinci and Arad, and in Hungary that is part of country area of Csongrad. In Serbia, size of Banat is 9276 km<sup>2</sup>, in Romania 18966 km<sup>2</sup> and to Hungary belong 284 km<sup>2</sup>. The territory of Banat is mostly lowland area with a large numbers of microforms of relief and the alluvial plains of the River Danube, Tisa, Begej, Tamiš, Karaš and Nera. Except alluvial plains, relief of Banat follows terraces, loess, sandy terrains and small part belongs to a mountain which highest peak represent Vršačke planine with Gudurčin vrh (641m).

The size of analyzed area is 40000 km<sup>2</sup>, respectively 200x200 km area so it would be covered the entire territory of Banat and some part of neighboring areas to determine influence outside of the border of Banat and to see optimal display of data.

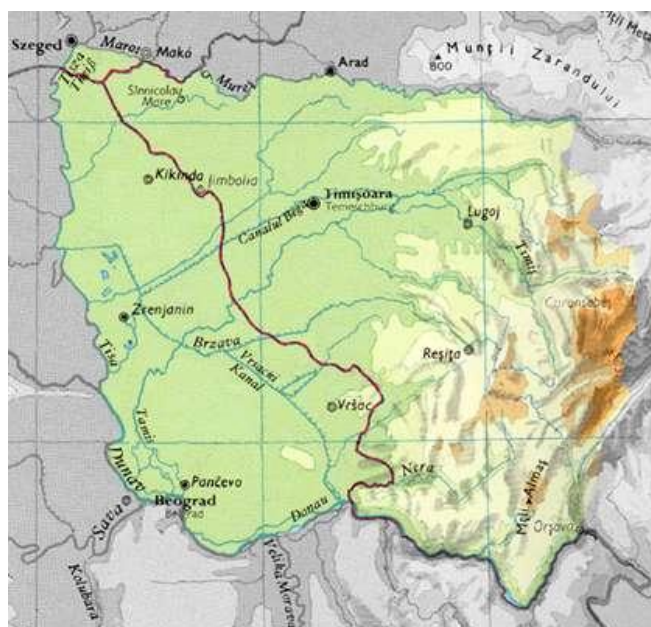

Figure 1. Modern Banat (<http://www.hongrieforum>)

The total population in the region of Banat is 1838463 and they represent a population that is, depending on meteorological parameters in a greater or lesser extent, exposed to every day pollutions under the foreign industry and energy output systems. Of the total population in the Serbian part of Banat live 665397 inhabitants, Romanian 1011145 inhabitants and in Hungary, respectively only the city of Szeged live 161921 inhabitants. Most of the population lives in urban areas and the largest cities are Zrenjanin, Pančevo, Kikinda, Vršac, Borča, Novi Sad, Kovin, Bela Crkva, Timisoara, Resita, Lugoj, Caransebeș, Boksa, Nova Moldava, Oravica, Sannicolau Mare, Orșava, Oțelu Roșu, Jimbolia, Lipova, New Arad and New Szeged in Hungary (<http://en.wikipedia.org/wiki/Banat>).

### ADMS

ADMS 5 – is the dispersion model that can simulate a wide range of pollution from diffuse sources of pollutants. That is a new generation dispersion model that uses two parameters in order to define the boundary layer of the atmosphere, the height of the boundary layer and the Monin-Obukov length, as well as adjusted Gus's distribution of concentrations in order to calculate the dispersion in convective



conditions. With dispersion model we can calculate the long-term and short-term concentrations and spreading fluxes from continuous sources, streams, line, surface and volume sources. The paper presents the emission data point sources, or thermal energy output sources chimney and chimneys of boiler plants, and industrial plants of chemical industries. Data that characterize emitter are height and diameter of the chimney, the type of pollution sources (spot or line), the speed and flow of the flue gas, its temperature and the geographic coordinate of emitters in space [ADMS 5, 2015].

### **MODEL INPUT DATA**

To create the simulation, data of thermal power plants that are found in Banat and that for the most part threaten air quality both in Serbian, as well as in the Romanian part of Banat will be used. Considering that for creation of simulations, except data about emissions of pollutants, an important figure represents meteorological data, we will use the most representative data from the field. Area in which research will be done is quite large and there are different meteorological characteristic parameters. For this work we will use meteorological parameter of central Banat.

### **EMISSION**

Table 1. Represents emission data of thermal power plants on Banat area. In the analyzed plants are involved the largest power plants that are located in the border region of Banat, and that may have a direct cross-border impact. Thermal power plants using lignite, fuel oil and natural gas as fuel for production of heat and electricity. In the process of burning fuel using coal, pollution emissions are expressed in NO<sub>x</sub>, SO<sub>2</sub> and suspended particles with a diameter of 10 μm, respectively known as PM<sub>10</sub>. These pollutants represent pollutants whose concentrations directly affect air quality. For the purposes of the simulation, emission values in g/s were used which are obtained with estimation of annual values of pollutant emissions from thermal power plants. Temperature value of the flue gases as a very important element in simulations and gas spreading, are taken daily medium values, even though at these values the deviations are minimal.

Table 1. Sources of pollution in the region of Banat region ([www.envirobanat.ro](http://www.envirobanat.ro))

Name	Process description	Height	Diameter	Fuel	Flue gas temperature		Flue gas exit velocity	Pollutant mass flow [g/s]			
		m	m		°C	K		NOx	CO	SO2	PM
ROMAG TERMO Halanga	heat and power	243	8.3	lignite	145	418	17.2	295.9758	49.3083	3983.1940	62.8266
	heat and power	280	8.3	lignite	140	413	15.9	308.2148	55.4525	3864.5240	15.5483
CET SUD, Timisoara	heat and power	165	5.04	lignite	151	424	14.5	83.4868	34.4200	1542.2540	13.2554
	heat and power	170	5.04	lignite	145	418	13.2	54.2664	22.3730	812.1254	8.6160
CET CENTRU, Timisoara	heat and power	48	2.5	NG	125	398	15.2	10.5542	2.5875	-	-
	heat and power	48	2.5	NG	124	397	15.1	11.2545	1.5480	-	-
	heat and power	48	2.5	NG	124	397	15.4	12.5421	2.3452	-	-
HIP Petrohemija Pančevo	etilene	30	1.5	NG	230	503	13.21	0.805	0.925		0.0363
		24	1.8	HF	230	503	13.76	0.91	0.5	0.94	0.361
		24	1.8	NG	230	503	13.76	0.75	0.33		0.033
		24	1.8	HF	215	488	14.52	0.86	0.44	7.69	0.305
	power & heat	40	2	NG	203	476	6.44	2.72	0.22		0.166
		40	2	HF	313	586	6.31	10.02	0.27	37.72	0.72
		40	2	HF	353	626	6.31	6.47	0.22	11.16	0.783
NIS Refinerija nafta Pancevo	oil refinery	9.15	1.14	G	120	393	4.96	0.195	0.0283		
		44.7	2.25	G	120	393	23.88	13.05	6.62	57.542	2.41
		156	2.4	G	120	393	26.49	1.42	0.86	4.55	0.152
		156	2.44	G	120	393	11.5	1.81	6.248	5.008	0.184
		156	2.44	G	120	393	1.8			9.74	
		21	1.1	G	120	393	9.1	0.335	0.0638	0.24	0.00916
		23	1	G	120	393	7.44	0.201	0.066	0.186	0.01805
		36	1.8	G	120	393	24.5	8.68	1.077	36.861	0.708
AT Radijator Zrenjanin		11.4	0.75	NG			5.51	0.097			
		5	2.5				29.54	0.207		0.248	
		12	0.4				18.74	0.07			
		12	0.28				28.32	0.025			
MSK Kikinda	Methanol & acetic acid	50	2.8		117	390	6.6	3.64	0.363		0.05
		30	0.7		430	703	13.25	0.29	0.025	0.022	0.0027

## METEOROLOGY

Meteorology parameters are perhaps the most influential parameters affecting the dispersion of pollutants in the middle, and therefore their evaluation and selection significantly affect the quality of research results. The area of research is the size of 200x200 km, or 40000 km<sup>2</sup> and therefore area is characterized by different characteristic meteorological parameters. Over choosing meteorological parameters from different weather stations, parameters of several different spatial areas were analyzed in which are plants whose emissions will be analyzed. Data from the meteorological station that were available were related to the area of central Banat and the city of Zrenjanin, southern Banat and the town of Kikinda and the city of Smederevo and Kostolac. When analyze of the data, we came to the conclusion that the most representative meteorological data represent data from meteorological stations in Zrenjanin.

Operation of thermal power plants is most intense during the winter months as it is in those periods, except for production of electricity, hot water is also being produced in most of the storage facilities which is used for heating of residential buildings in the remote heating system. For this reason we used data from a winter period for forming of meteorological parameters, i.e. the period of heating season from 1. November 2014. – 1. March 2015. And during the heating season plants that produce electricity operate at full capacity because in this period the use of electric power for heating rooms is intensified.

Figure 2. shows the wind rose meteorological data from winter 2014/2015 which will be used in the forming of the pollution dispersion scenarios.

ADMS\Prekogranični uticaj termotoplana\prekogranični integrisanilPrekogranični - Banat .

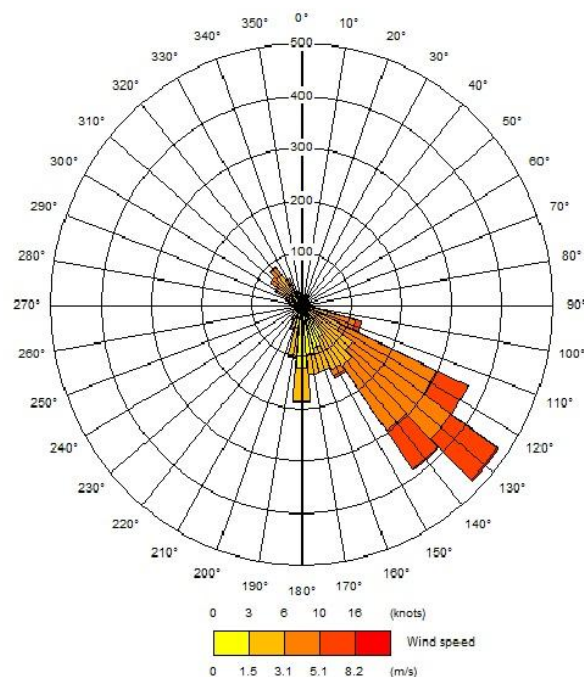

Figure 2. Wind rose - winter 2014/2015

Meteorological parameters show that in the maximum wind speed 8.8 m/s south - east wind is dominant and the average wind speed is 2.67 m/s. To form the scenarios, beside the basic meteorological parameters, direction and wind speed we using data on temperature, relative humidity and cloud cover. In the period November 2014 - March 2015 temperatures moved in the range of -12 °C to 24 °C, average temperature was 6.01 °C. The average relative humidity in the analyzed period was 78.12 %.

**RESULTS AND DISCUSSION**

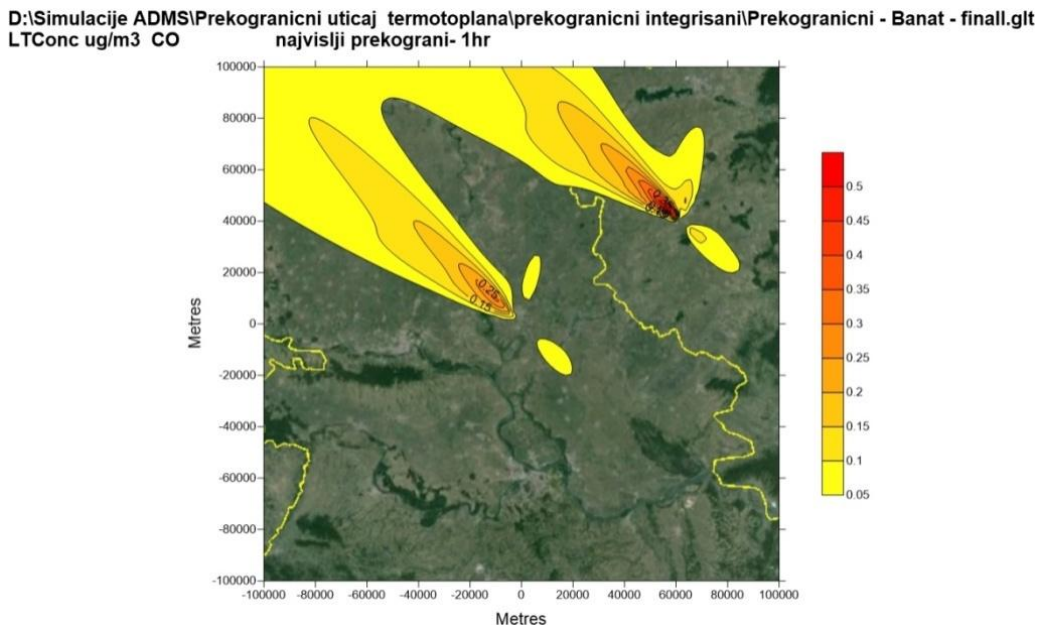

Figure 3. CO concentration in analyzed area

Figure 3. shows a simulation of CO propagation of in the analyzed area. The concentration of CO varied in the range of 0.05 - 0.5  $\mu\text{g}/\text{m}^3$ . This concentration is far below the limits prescribed in the legislation of the Republic of Serbia for ambient air which is prescribed at 10  $\text{mg}/\text{m}^3$  averaged 8 hours. It is also far smaller than the average value of 3  $\mu\text{g}/\text{m}^3$  when averaging performed annually, which is perhaps more relevant in our case, considering that it is a long-term simulation analysis of 4 months period [“Sl. glasnik RS”, br, 11/2010].

Conditioned with metrological parameters, most burdened larger settlements with these pollutants are settlements that are located in the northern part of Banat from both the Romanian and the Serbian side of the border. These are the following settlements: Kikinda, Kanjiža, Kneževac, Zrenjanin, Timisoara, Arad, Subotica and Szeged.

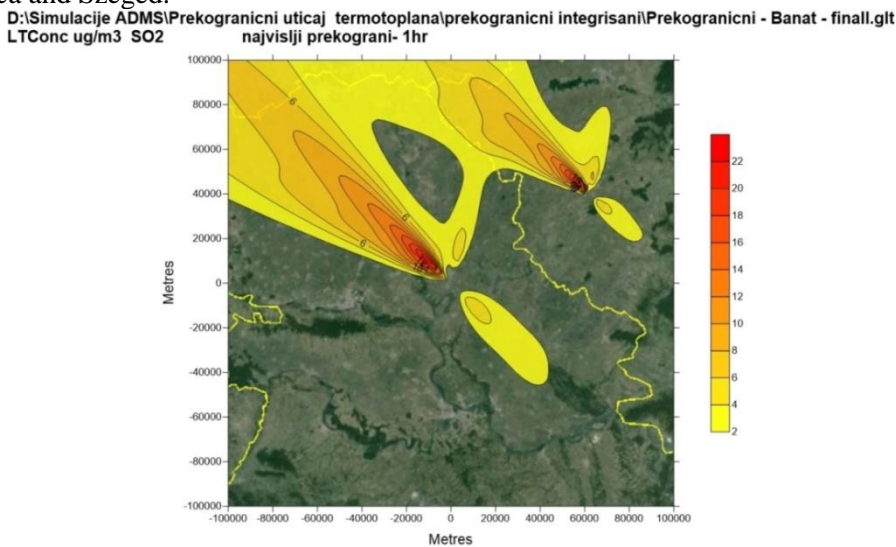

Figure 4. SO2 concentration in analyzed area

Concentration of SO<sub>2</sub> in analyzed area moved within range of 2-22 µg/m<sup>3</sup>. This pollutant is produced by burning of coal, which is used for production of heat, and therefore production of electrical energy in hot water facilities. Thermal power systems in Serbia using coal as energent in drastically lesser extent. In Romania this energent is in a much greater exploitation and to a larger degree is used by thermal power plants - heating plants in the immediate vicinity of Timisoara. The projected concentration in level of 22 µg/m<sup>3</sup> is below the upper limit value, which is 125 µg/m<sup>3</sup> for the averaging period of 24 hours, respectively far below the value of 350 µg/m<sup>3</sup> in the case of averaging on 1 hour period.

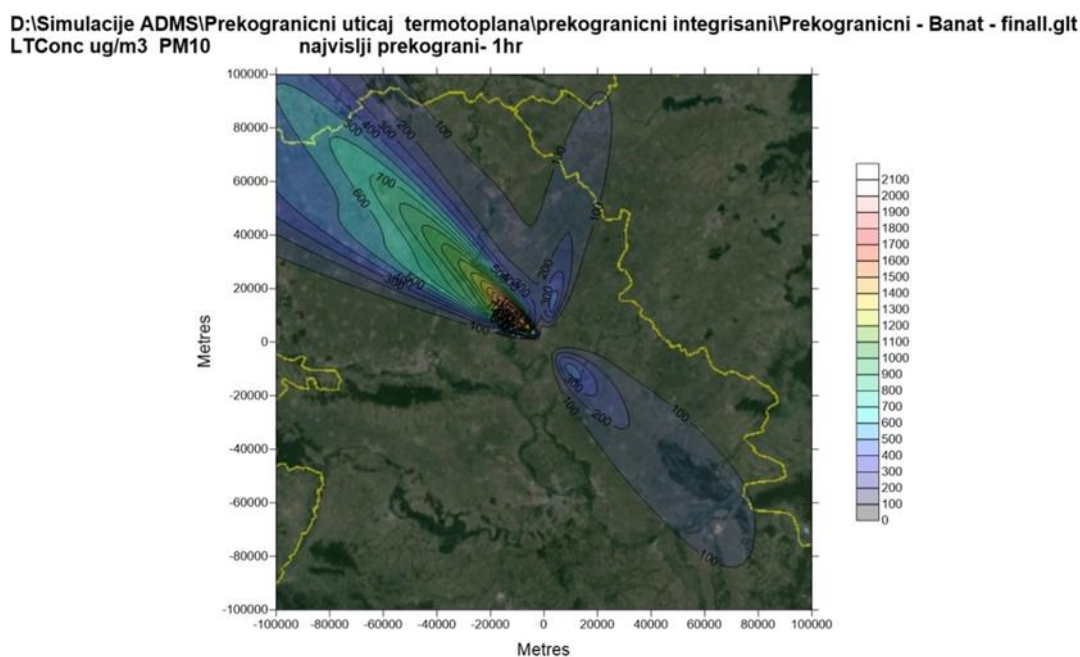

Figure 5. PM10 concentration in analyzed area

The concentrations of suspended particles PM10 in the analyzed area near the source was over 2000 µg/m<sup>3</sup>, although the concentration over long distances (over 50 km) amounted to 200 - 700 µg/m<sup>3</sup>. Sources of this pollutant are primarily thermal power plant in Zrenjanin. The concentrations of this pollutants as well as the concentrations of other pollutants is far below the upper limit value which is 50 µg/m<sup>3</sup> in case of averaging on 24 hours and 40 µg/m<sup>3</sup> in the case of averaging on annual level [Directive 2008/50/EC].

## CONCLUSION

Simulations of pollutants dispersion created by emission from thermal power plants in the region of Banat with the Romanian and Serbian sides show us that there is cross-border impact. Conditioned by meteorological data used for forming simulation clearly indicate that the most vulnerable areas are parts of Central and Northern Banat. The concentrations of pollutants are far below the upper limits prescribed by the legislation of the European Union and the Republic of Serbia on the ambient air quality. The results show that there is no doubt influence and that these plants affect on the overall air quality in the region. These plants represent only a small part of emission sources, and the results show that their participation is very important. To create a more comprehensive picture of air quality in the region, it is necessary to include as many pollution emitters as can in the future as well as traffic pollution as a line source of pollution. Traffic nowadays is becoming increasingly dominant source of pollution, whose negative impacts likely to be felt beyond the borders of the country where the pollutants were emitted.

## **ACKNOWLEDGEMENT**

This paper is a result of the research activities, data and result obtained using the equipment and software under the project 'Sustainable DEVELOPMENT OF AN RESEARCH CENTER IN BANAT DANUBE AREA AND FLOW THROUGH SCIENTIFIC RESEARCH AND ENVIRONMENTAL SIMULATION TOOLS ACCESS AND EVALUATION THREATS, " MIS CODE 1425, which is financed by the IPA CBC ROMANIA - SERBIA.

## **REFERENCES**

- ADMS5 user manual, 2015, Cambridge Environmental Experts Consultants, Cambridge, UK  
Directive 2008/50/EC of the European Parliament and of the Council of 21 May 2008 on ambient air quality and cleaner air for Europe  
<http://www.hongrieforum.com/phpbb/viewtopic.php?t=2499&sid=9dab32744f497c303333b2d43087083c>  
<http://en.wikipedia.org/wiki/Banat>  
<http://www.envirobanat.ro>  
Rao, M.N., Rao H.V.N. (2007), Air Pollution, Tata McGraw-Hill Publishing Company Limited, ISBN 0-07-451871-8.  
Uredba o monitoringu i zahtevima kvaliteta vazduha, ("Sl. glasnik RS", br, 11/2010)

V International Conference  
„ECOLOGY OF URBAN AREAS“ 2016

## THE INFLUENCE OF WIND POWER ON THE ENVIRONMENT

E. Škrgić, S. Mirjanić

Faculty of Natural Sciences, University of Banja Luka, Bosnia & Herzegovina

### ABSTRACT

*One of the ways of dealing with the electricity demand is exploitation of wind energy. Negative effects which the use of wind turbines has on the environment and which are the result of its work have also been considered. The current review of the wind energy in the area of Bosnia and Herzegovina has been given in this paper.*

**Key words:** *wind energy, the environment, negative effects of wind energetics.*

### INTRODUCTION

For thousands of years wind has been used as a source of power. According to historical records, sailboats (felucca) in ancient Egypt were actuated by the wind power. In Persia, wind power was transformed into mechanical energy, so it could be used to pump water or grind grain. At that time, other energy sources were unknown, except from slaves and animals which were used for manual labour. Wind power also helped Columbus to travel to America. There are millions of windmills worldwide used to pump water. During the 1990s there were 600000 windmills just in Argentina, 250000 in Australia and 100000 in southern Africa. In this paper the focus is going to be on the windmills mainly used to generate electrical power.

The increase in global demand for electricity is present nowadays, not only in industrialised countries (whose standards demand more power per inhabitant annually) but also in countries with galloping economy. To satisfy these needs the question how to meet future energy demands must arise. Keeping in mind today's environmental problems caused by the use of fossil fuels, solutions for the alternative energy sources are being imposed. Increasing investments in various forms of alternative energy have opened great opportunities for wind power industry.

Economic crisis in 1973 and environmental problems both contributed to mass production of wind power plants. The success of windmills implementation is also the result of technological advances in production.

Despite the fact that certain forecasts predicted only local significance for individual households<sup>1</sup>, wind energy is getting a greater perspective for wider application. The technology of wind power plants has made substantial progress, although there is still enough space for improvements. The fact is that when it comes to profitability it's a factor that does not support this type of power units. The growing environmental awareness of energy consumers must also be noted, bearing in mind the exhaustion of traditional sources, what certainly makes this issue a current discussion topic. The key issue is the criterion of cost effectiveness which is dependent on adequate location with favourable winds. It must be emphasized that this does not refer to the high intensity winds, but the constant long blowing winds. Although the wind is a stochastic phenomenon, we can predict it.

### WIND TURBINES

Wind speed, or the available amount of energy generated from the wind is a decisive factor for locating the wind turbine. That is why available data both from nearby meteorological stations and the measurements of wind speed from a certain location are required. The process of characterization is a

---

<sup>1</sup> Ristić M., O energiji, str 51

relatively long process which takes at least 12 months. In addition to the measurement results, the theoretical distribution functions of wind speed, such as Weibull and Rayleigh are used too. Standard measurements of wind speed are carried out at the height of 10m<sup>2</sup>.

Essential feature of wind is being described by speed and direction. Wind strength in meteorological practice is expressed by the visual effect in so-called Beaufort scale (Francis Beaufort 1774–1857). Smoke rising vertically upward, just as motionless leaves, is, according to the mentioned scale marked as 0 degree. The strongest wind, that desolates, is marked with 12 on the scale. Its speed reaches over 32,7 m/s. Wind direction is determined by the side of the world from which it blows.

Configuration of the terrain can lead to a significant increase in wind speed, as in the case of so-called "Tunnel effect". When the wind passes through the notch, or between tall buildings, where the area is significantly narrowed it comes to wind compression and an increase in the speed of its flow. The hill effect is often used when choosing the location of turbines. The air becomes compressed by crossing the hills where it comes to an upward turn with the increase of wind speed. The mentioned positive effects can be interesting when selecting potential locations for power plants.

Depending on the way how the blades exploit wind energy (classification by aerodynamic effect), we can distinguish those that operate on the principle of force resistance those are wind turbines with resistant action (drag device) and those that operate on the principle of buoyancy buoyancy effect (lift devices). There are those that combine both models. Wind turbine blades which operate on the principle of resistant action have a lower efficiency than those which operate on the principle of buoyancy and that is the main reason why the buoyancy type blades or the combined type are mainly used.

Betz's Law determines the maximum energy we can get from the wind or the fluids flowing at a certain speed. The moving particles have kinetic energy, according to this flowing wind also has kinetic energy. After getting over an obstacle, in this case the turbine, wind gives over apart of its energy. The consequence of this is that on the other side of the turbine wind speed is lower than the speed that has reached the turbine and that could be reached in an ideal case. Under the ideal case is considered that all the air behind the turbine is stopped, and thereby the turbine had taken over all of the energy or power. In reality, mentioned situation is impossible, because the air must flow when it passes the turbine. According to Betz's law, an ideal turbine, which reduces the speed for 2/3, has a maximum amount of efficiency of 16/27 or 59.3%. Practical amount of energy transformation is of course lower and amounts between 35% and 45%.

The most important device in terms of wind energy is the wind turbine. This is a relatively complex device, which, powered by wind power, generates electricity.

There are various types of wind power plants, and a typical example is shown in Figure 1:

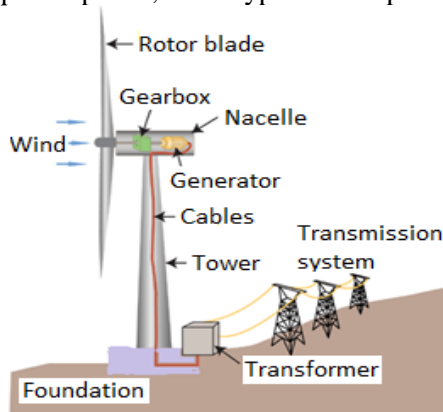

Figure 1. Basic elements of a wind power plant

<sup>2</sup> [http://www.firewords.net/definitions/10-meter\\_wind\\_speed.htm](http://www.firewords.net/definitions/10-meter_wind_speed.htm)



Basic parts of wind turbine are shown in Figure 2<sup>3</sup>.

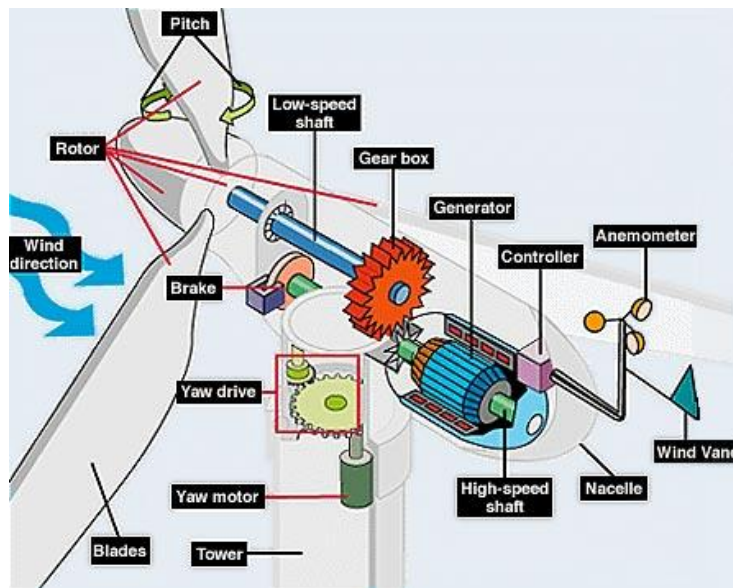

Figure 2. Classical wind turbine components

The image shows main parts. Of course, the number of components is much higher. In order to simplify, some parts, such as the cooling system, engine and gearbox shock absorbers are omitted. When it comes to the negative sides of wind turbine, and especially of wind parks, it is important to mention the noise they make. There are two sources of noise when they operate, aerodynamic and mechanic. When air masses come to an obstacle (blade) they split and as a result of the flow disturbance a characteristic noise appears. Besides the mentioned noise there is also a noise made by the mechanical parts that rotate inside a case (cogged transporters, bearings,...). New findings in the development of wind turbines have led to a significant decrease of the noise level in comparison with previous generations. This decrease amounts from 5 to 10 dB(A). Noise levels are shown in table 1:

Table 1.

Source of noise	Distance [m]	Level of noise [dB]
Pain tolerance threshold		140
Boat horn	30	130
Jet engine	60	120
Cargo train	30	70
Vacuum cleaner	3	70
Highway	30	70
Small wind turbine (10 kW)	36	57
Large transformer	40	55
Wind in trees	12	55
Cross road with traffic lights	30	50

Source of noise	Distance [m]	Level of noise [dB]
-----------------	-----------------	------------------------

<sup>3</sup> <http://www.thesolarguide.com/wind-power/turbine-parts.aspx>

Average household		50
300 kW wind turbine	120	45
USW 56-100 turbine	240	45
Audibility threshold		0

By increasing the distance from a wind turbine the level of noise decreases, which can be compared with the other sources of noise. The imagery is taken from<sup>4</sup>, and it shows the comparative review of the different individual noise sources.

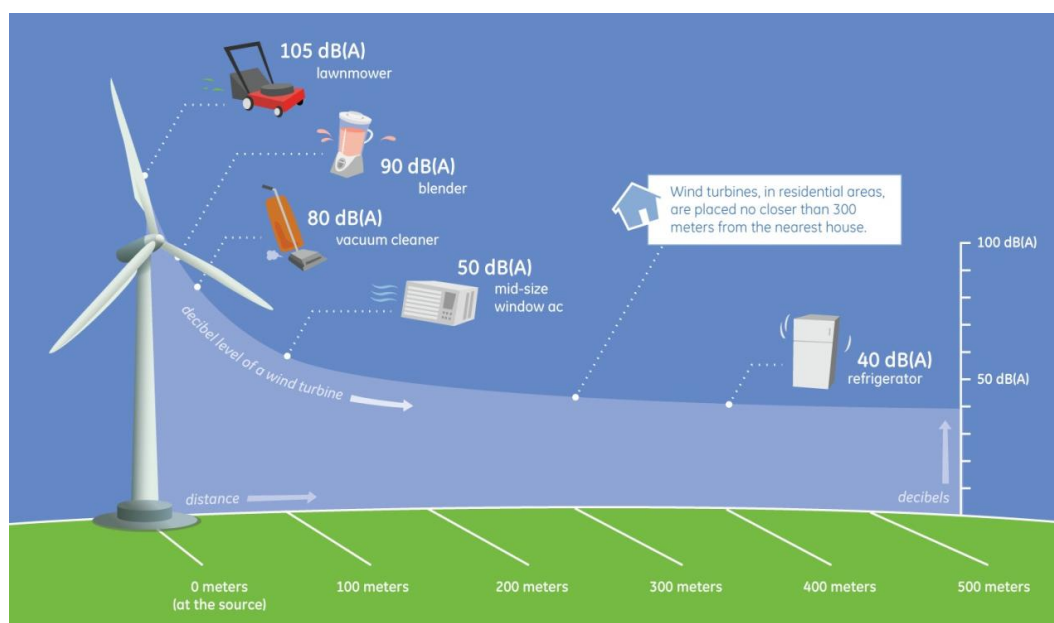

Figure 3. The noise level compared with other different sources. Acceptable noise level for residential buildings is below 45 dB

There is also the effect of shadow influence. This refers to the shadow that comes from the rotor blades during the sunny periods. Shadow can have adverse influence on people who live near wind turbines. Because of this the mentioned factor has to be taken into consideration when choosing a location.

Another problem arose lately in areas where the plants are set up, and it concerns the visual distortions of environment. There is also the possibility of animal habitats disturbances, this especially refers to propellers that can kill birds which fly into them. Namely, mountain ranges are an attractive location due to a channel effect in which the flow is intense. Such sites are common routes of migratory birds. Cooperation with environmental organizations can bring about an appropriate strategy. Wind power plant facilities require land, mostly open areas such as agricultural land. In that case, despite the fact that the facilities would take a large area, really occupancy would be considerably smaller. After the construction work on carrier pillars there would remain enough space between them to be used for initial purposes. We should mention that the stands can also be used for next generation of wind power plants. We should not forget the revenue they bring to rural communities for being set up on their land. These plants also change the appearance of nature. This effect is being moderated through appropriate design, layout as well as colour.

Simply put, the wind represents the movement or flow of air. It occurs as a result of the Sun's uneven heating of the Earth's surface.

<sup>4</sup> <http://www.gereports.com/post/92442325225/how-loud-is-a-wind-turbine/>

According to estimates, in general, 1,700 GW of wind power is available. Unfavorable areas should be excluded from this amount, what leads to an estimated approximate amount of 72 to 170 GW. In addition, there are characteristic winds in certain areas called local winds.

Wind energy represents a transformed form of solar energy and therefore ranks among the renewable energy sources. As long as the Sun is present, the winds will blow in nature. Thus, like other renewable sources, besides geothermal and tidal energy, the Sun is an indirect source of wind energy. According to some estimates, it is believed that less than 3% (according to some meteorologists 1%) of solar energy that falls on the earth is being converted into wind energy.

State in terms of wind energy in the B&H and Republic of Srpska

In order to exploit the wind potential, the appropriate environment for the development of alternative energy sources must be created. The efforts of EU member states are aimed at so-called 20-20-20 principle. Namely, it's an effort to reduce energy consumption and eliminate energy losses, in addition to increasing the use of energy from renewable sources up to 20% in Member States by the year of 2020. The estimated improvement of energy usage effectiveness is 20%, and 20% is also the estimated reduction of harmful gases emission into the atmosphere. South-east European countries are also trying to implement the mentioned 3·20% strategy by building a series of wind power plants. Bosnia and Herzegovina also committed itself to the mentioned principle. As a result, A National Action Plan for the use of renewable energy sources in Bosnia and Herzegovina was adopted. The aim of enacting the appropriate legal solutions is to encourage the production and consumption of electricity from the so-called renewable energy sources and cogeneration plants, as well as the removal of obstacles for an increase in usage of renewable energy sources, including the administrative ones. Taking into account the specific arrangements of the country, a brief overview of the legal legislation will be given for both parts.

The Federation government has declared the use of renewable energy sources and cogeneration plants as a case of general interest in 2010. In terms of legal legislation the relevant legal acts were also adopted in 2010. The Federal government passed a decree on the use of renewable energy sources and cogeneration. Appropriate legislative amendments to Regulation followed in March and December 2011. The Draft Law on use of renewable energy sources and efficient cogeneration (REC) followed in 2010<sup>2</sup>, and after that, the Law on energy efficiency in the Federation, according to which the cantons are obliged to make plans for their energy efficiency. The Decree on stimulating the production of electricity from REC and determining compensation for encouragement was issued in 2014. According to the issued regulations, REC can be treated, depending on the installed power, as micro plants up to, and including 150Kw, mini plants from 150kW to, and including 1MW, small plants from 1MW to, and including 10MW, large plants over 10KW. It is important to mention the Charge regulation from 2010 by which 0.001KM/kWh (without VAT) must be paid by all end consumers. This is being shown as a separate item on the electricity bills in order to enhance the electricity production from REC.

At the beginning of 2011 the Government of Republic of Srpska has issued a Decree on Generation and Consumption of Energy from Renewable Sources and Co-Generation. The same year in March the Regulation of production and consumption of energy from renewable sources and cogeneration has been issued. The Law on Energy efficiency from 2013 among other areas, also treats the Law on renewable energy sources and efficient cogeneration. Amendments and additions to the Law followed during the year. Regulation of production planning and consumption of energy from renewable sources has been issued in 2013 through an Action plan of RS for the use of renewable energy sources. Amendments on Regulations of enhancing the production of energy from renewable sources and efficient cogeneration followed in April 2016. The charge for end consumers for enhancing the production from renewable sources for 2016 is 0.0025KM/kWh (without VAT). There is a number of regulations and decrees on the issue in RS and they are available at the webpage of the Regulatory board for energetics of RS (<http://www.reers.ba/lat/node/1298>).

There is an Association of renewable sources energy producers in Bosnia and Herzegovina whose official website is <http://apeor.com/>. Development strategies for Federation of BiH and also RS, reference prices for the current year and many other documents are available on this webpage.

WPP Moštre 1,350 kW, on Visoko location, was released in BiH in 2013.

According to the following are being prepared for release:

WPP Orlovača, Livno, 20 generators of 2,1 MW power each

WPP Baljci, Tomislavgrad, 16 generators of 3 MW power each

WPP Gradina, Tomislavgrad, 35 generators of 2 MW power each

WPP Bitovnja, Konjic, unknown number of generators and power

WPP Medvedak, Bihać, unknown number of generators and power

WPP Rostovo, Bugojno, unknown number of generators and power

WPP Vlašić, Travnik, unknown number of generators and power

WPP Podveležje, Mostar, 16 generators most likely to be 3 MW each

WPP Kamena 1, Livno 25 generators, 2 MW each

WPP Bahtijevca, Mostar-Konjic, 18 generators, 2 MW each

WPP Morine, Nevesinje, 20 generators, 2 MW each

WPP Grebak, unknown

WPP Mesihovina, Tomislavgrad, 22 generators, 2,5 MW each

WPP Velika Vljajna, Mostar, 16 generators, 2 MW each

WPP Poklečani, Posušje, 36 generators, 2 MW each

WPP Livno (Borova Glava), 26 generators, 2 MW each

WPP Mokronoge, Tomislavgrad, 35 generators, 2 MW each

WPP Srđani, Tomislavgrad, 15 generators, 2 MW each

WPP Planinica, Mostar, 21 generators, 2 MW each

WPP Crkvine, 12 generators, 2 MW each

WPP Velja Međa, Ravno, 9 generators, 2 MW each

WPP Debelo Brdo, Livno, 26 generators, 2 MW each

WPP Kamena, 8 generators, 2 MW each

WPP Pločno, 17 generators, 2 MW each

WPP Podveležje, 15 generators, 3 MW each

WPP Glamoč 1 (Slovinj), Glamoč, 41 generators, approximately 3 MW each

WPP Glamoč 2 (Dževa), Glamoč, 19 generators approximately 2 MW each

WPP Hrgud, Berkovići, 16 generators, 3 MW each

WPP Mučevača, Livno, 30 generators, 2,1 MW each

WPP Relaks, Posušje, 10 generators, 3 MVA each

WPP Jelovača, Tomislavgrad, unknown

WPP Ivovik, Tomislavgrad, 42 generators, 2 MW each

WPP Derale, Bosansko Grahovo, 29 generators, 3 MW each

WPP Trusina, Nevesinje, 17 generators, 3 MW each.

## CONCLUSION

Power energetics is a relatively young field, but with a huge and persistent collecting of knowledge and experience, it is emerging as one of the promising energy sources. The variety of innovative technological solutions that significantly improve the efficiency and reduce the price of gained kWh have to be added to this. Electricity generated from wind power currently has a cost of 5-8 € cents per kWh, and predictions are that it will fall below 4 € cents. The total cost of power production consists of three items: the capital (investment) costs that include the total investment, which consists of the conditions of financing (interest and repayment period), operation and maintenance costs, as well as fuel costs. Unlike the conventional energy sources fuel costs are not present with wind energy. Out of the total amount the best price obtained from gas is in the amount of 0.036 € / kWh, followed by thermal power plants in the amount of € 0.046 / kWh. Price obtained from nuclear power plants as

well as from wind turbines is € 0.057 / kWh. Data were taken from<sup>5</sup>. Certain disagreements over prices are present, because, according to other sources, the best price is for the energy obtained from thermal power plants. The differences are most likely present due to the availability and accessibility of a certain energy in electricity production for a specific country. Nonetheless, the fact is that the price decrease of kWh produced from wind generators is present, what is clearly shown in Fig 46:

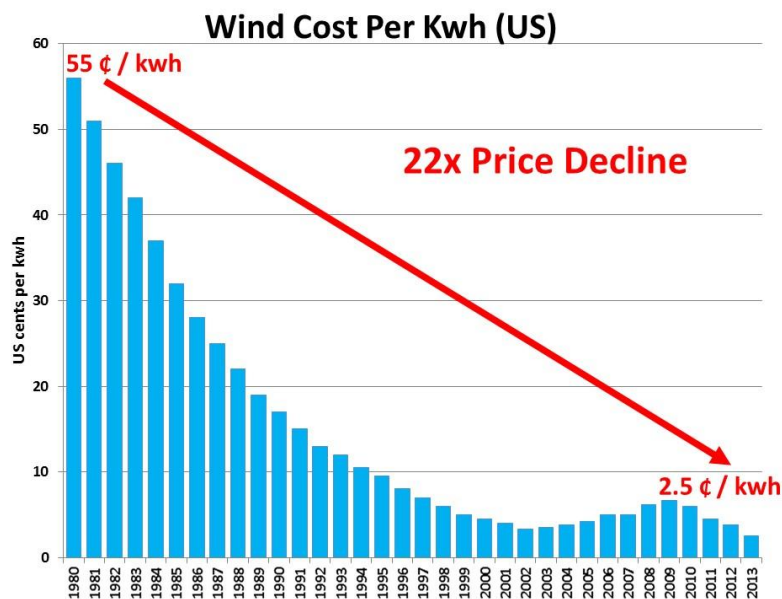

Figure 4. Trend of constant decrease in prices per kWh

The image taken from 7 shows a trend of decrease in the price of energy produced per kWh in the last fifteen years. Small wind power plants might be of interest for "small consumers", that is the application of wind energy for the household. When it comes to areas remote from the regular electricity network, one of the solutions for the problem of electrification are wind power plants, which can be used as the primary power source (e.g. for cottages). These can be used as an additional source of energy, in addition to the primary sources from the electricity network or generators, which can be connected to the alternate networks through the appropriate electronic devices (converters). Of course, resulting energy storage devices – batteries should not be forgotten.

This concept is interesting for objects that are located away from the main distribution networks.

## REFERENCES

- Brumme A. Wind Energy Deployment and the Relevance of Rare Earths: An Economic Analysis, Springer Gabler, Technische Universität Chemnitz, Germany, 2014.
- Busby, Rebecca L.: Wind power : the industry grows up, PennWell, Tulsa, 2012.
- Chortis I.D, Structural Analysis of Composite Wind Turbine Blades, Springer, University of Patras, Greece, 2013.
- [http://en.wikipedia.org/wiki/Wind\\_gradient](http://en.wikipedia.org/wiki/Wind_gradient)
- Gvozdenac D., B.Nakomčić-Smaragdakis, B. Gvozdeanac-Urošević, Obnovljivi izvori energije, Fakultet tehničkih nauka, Novi Sad, 2011.
- [http://www.ieee.hr/\\_download/repository/DR10MBajcic.pdf](http://www.ieee.hr/_download/repository/DR10MBajcic.pdf)
- Kaltschmitt M, Streicher W, Wiese A. Renewable Energy Technology, Economics and Environment, Springer-Verlag, Berlin, Germany, 2007.
- <http://marjan.fesb.hr/~fbarbir/PDFs%20Obnovljivi%20izvori/Dodatni%20materijali%20i%20predavanja/Energija%20vjetra%20Matijasevic%20CTT.pdf>
- Pavlović, T. M., Milosavljević, D. D., Mirjanić, D. Lj.: Obnovljivi izvori energije, Akademija nauka i umjetnosti Republike Srpske, Banja Luka 2013.

<sup>5</sup>[http://powerlab.fsb.hr/turbostrojevi/Vjetroturbine\\_i\\_postrojenja.pdf](http://powerlab.fsb.hr/turbostrojevi/Vjetroturbine_i_postrojenja.pdf)

<sup>6</sup><http://rameznaam.com/wp-content/uploads/2014/10/Wind-Power-Cost-per-Kwh.jpg>

[http://powerlab.fsb.hr/turbostrojevi/Vjetroturbine\\_i\\_postrojenja.pdf](http://powerlab.fsb.hr/turbostrojevi/Vjetroturbine_i_postrojenja.pdf)

Ristić M. D., O energiji, Zavod za udžbenike i nastavna sredstava, Beograd 1995

Schaffarczyk, A.: Understanding wind power technology : theory, deployment and optimisation, John Wiley & Sons, UK, 2014.

[http://tesla.pmf.ni.ac.rs/people/nesiclj/predavanja/fizika\\_okoline/2012/vetar%20i%20hidrosfera.pdf](http://tesla.pmf.ni.ac.rs/people/nesiclj/predavanja/fizika_okoline/2012/vetar%20i%20hidrosfera.pdf)

<http://www.unizd.hr/Portals/6/nastavnici/Sanja%20Lozic/Klima%204.pdf>

Vaughn N. Wind energy: renewable energy and the environment, CRC Press, USA, 2009.

Wizelius T.: Developing Wind Power Projects -Theory and Practice, Earthscan, UK, 2007.

V International Conference  
„ECOLOGY OF URBAN AREAS“ 2016

## CERTAIN MODELS IN THE ANALYSIS OF AIR POLLUTION

Stevo K. Jaćimovski<sup>1</sup>, Vjekoslav D. Sajfert<sup>2</sup>, Jovan P. Šetrajčić<sup>3</sup>, Slobodan Miladinović<sup>1</sup>

<sup>1</sup>Academy of Criminalistic and Police Studies, Belgrade, Serbia

<sup>2</sup>University of Novi Sad, Technical Faculty “Mihajlo Pupin”, Zrenjanin, Serbia

<sup>3</sup>University of Novi Sad, Faculty of Sciences, Department of Physics, Novi Sad, Serbia

Academy of Criminalistic and Police Studies, Belgrade, Serbia

stevo.jacimovski@kpa.edu.rs, sajfrtv@open.telekom.rs, jovan.setrajcic@df.uns.ac.rs,

slobodan.miladinovic@kpa.edu.rs

### ABSTRACT

*This paper discusses possible models for analyzing the spread of air pollution from stationary point sources. The model for solving the diffusion equation in turbulent atmosphere is analyzed first. The equation is solved analytically and requires a specific solution for the corresponding initial and boundary conditions. This type of equation is then solved numerically using the Mathematica 8 software package. Finally, the statistical Gaussian model for the spread of air pollution is analyzed with the same initial and boundary conditions by using the Screen 3.5 software package. The results of all three approaches are given simultaneously with their advantages and disadvantages specified.*

**Key words:** air pollution, stationary point sources, diffusion equation in turbulent atmosphere, Gaussian statistical model.

### INTRODUCTION

Emission of harmful substances into the atmosphere adversely affects the state of the atmosphere, which represents a vital component of nature. In order to limit the negative share of harmful substances in the atmosphere, certain norms regarding their permissible values have been determined and an automatic monitoring of air quality control has been introduced. Automatic stations measure the concentration of various impurities in the air. The level of pollution is determined by comparing the measured concentration with the maximum permissible concentration which is acceptable since it does not affect human health.

Regardless of the fact that the information obtained through measuring stations represents the actual state of the atmospheric air in places in which the measurement is made, the causes of air pollution remain unknown. Furthermore, such information indicates the level of pollution only in certain points and cannot provide us with an adequate picture of the air quality in the entire desired territory. In order to solve these problems, mathematical modeling of the spread of air pollution is done, which makes it possible to assess the level of pollution in the desired point without performing adequate measurements. In addition, the use of mathematical modeling can predict changes in the atmospheric air for a longer period of time. Also, different hypothetical situations can be created (e.g. construction of a new factory which would represent a potential source of air pollution) and measures to prevent air pollution can be planned in advance. The modeling requires a complex consideration of many factors, such as the parameters of the sources of pollution, current meteorological state of the atmosphere, conditions of pollutant scattering at a given site, properties of pollutant substances, etc.

### SOME MATHEMATICAL MODELS IN THE ANALYSIS OF AIR POLLUTION DISTRIBUTION

In the analysis of the air pollution process, there is a substantial difference in whether it originates from stationary or mobile sources. As a rule, if air pollution comes from mobile sources it is of local character and reaches a low altitude. Air pollution from stationary sources (chimneys of factories, power plants, boilers, technological facilities etc.) reaches up to 150m and above and spreads over long distances. Air impurities in the air form air dispersion systems and due to turbulent movement and

other processes in the atmosphere they linger long in the air (Berlyand, 1985). Starting from the mathematical description method of the process of scattering impurities, different classes of models of air pollution analysis can be distinguished (Euler, Gauss, etc.).

**The Euler method**

During the 1980s, a group of researchers from the Faculty of Science in Novi Sad, gathered around academic Bratislav Tošić, conducted modeling of the spread of air pollution. In several works, for different conditions, they found analytical solutions of the equation of turbulent diffusion in the case of point sources of impurities in 1D, 2D and 3D case (Tošić 1982; Tošić 1984; Tošić 1988; Kapor 1983; Kapor 1988). When formulating the equations describing the process of spreading of impurities in the atmosphere and the change in their concentrations over time, it should be noted that the equations describe the mean values of concentration.

In a one-dimensional case, the diffusion equation in the non-stationary case can be written as:

$$\frac{\partial u}{\partial t} + v_x \frac{\partial u}{\partial x} = D \frac{\partial^2 u}{\partial x^2} - pu + f(x, t) \tag{1}$$

If we consider a point source, the source function can be written in the form:

$$f(x, t) = A\varphi(t)\delta(x) \tag{2}$$

where  $A\varphi(t)$  represents the amount of pollutants emitted in one second, and  $\delta(x)$  is the Dirac delta function. To make the situation as realistic as possible, it is assumed that:

$$\varphi(t) = \begin{cases} 0; & t \in (0, t_1) \\ 1; & t \in (t_1, t_2) \\ 0; & t \in (t_2, 2T) \end{cases} \tag{3}$$

where  $0 < t_1, t_2 < 2T; t_2 > t_1$ . Also, it is assumed that the source emits pollutants in the interval of  $t_2 - t_1$ .

This equation can be solved analytically (Tošić, 1982). The function  $\varphi(t)$  is developed into Fourier series in the form

$$\varphi(t) = \sum_{\nu=-\infty}^{+\infty} \frac{i}{2\pi\nu} \left( e^{-i\frac{\pi\nu}{T}t_2} - e^{-i\frac{\pi\nu}{T}t_1} \right) e^{i\frac{\pi\nu}{T}t}; \quad \nu \neq 0 \text{ @ } a_0 = \frac{t_2 - t_1}{2T} \tag{4}$$

and the solution is sought in the form

$$u(x, t) = \sum_{\nu=-\infty}^{+\infty} \int_{-\infty}^{+\infty} dk e^{ikx} u_\nu(k) e^{i\frac{\pi\nu}{T}t} \tag{5}$$

For boundary conditions  $u(\pm \infty, t) = 0$ . Assuming that the concentration of pollutants becomes equal to zero for  $t = 0$  the particular solution of equation (1) can be written in the form

$$u^\pm(x, t) = \frac{A(t_2 - t_1)\omega_0}{4\pi\sqrt{\alpha}} e^{-\left(\sqrt{\alpha m \frac{v_x}{2D}}\right) |x|} + \Upsilon \tag{6}$$

$$\Upsilon = \frac{A}{\pi} \sum_{\nu=1}^{+\infty} \frac{e^{-\left(\rho_\nu + \frac{v_x}{2D}\right) |x|} \sin \frac{\nu\omega_0}{2} (t_2 - t_1)}{r_\nu^2 + \rho_\nu^2} \cdot \left[ \frac{e^{-\rho_\nu |x|} \sin \nu\omega_0 t - r_\nu |x| - \frac{\nu\omega_0}{2} (t_2 - t_1)}{r_\nu^2 + \rho_\nu^2} + \rho_\nu \cos \nu\omega_0 t - r_\nu |x| - \frac{\nu\omega_0}{2} (t_2 - t_1) \right]$$

Here



$$\begin{aligned}
 r_v &= \frac{1}{\sqrt{2}} \frac{v_x}{v} \sqrt{\alpha^2 + \frac{v^2 \omega_0^2}{D^2}} - \alpha \frac{v_y}{v} \omega_0^{1/2}; \quad \omega_0 = \frac{\pi}{T} \\
 \rho_v &= \frac{1}{\sqrt{2}} \frac{v_x}{v} \sqrt{\alpha^2 + \frac{v^2 \omega_0^2}{D^2}} + \alpha \frac{v_y}{v} \omega_0^{1/2} \\
 \alpha &= \frac{v_x}{2D} \frac{\partial^2}{\partial x^2} + \frac{p}{D}
 \end{aligned}
 \tag{7}$$

it is clear that  $u^+(x, t)$  is valid for  $x > 0$  and  $u^-(x, t)$  for  $x < 0$ .

For the purpose of numerical solving of the equation (6) the following parameter values were adopted:

$$v = 4 \text{ m}; D = 1.39 \cdot 10^{-2} \text{ m}^2 / \text{s}; p = 2 \cdot 10^{-3}; A = 10^{12}$$

The result is shown in Figure 1 (Jaćimovski, 2012).

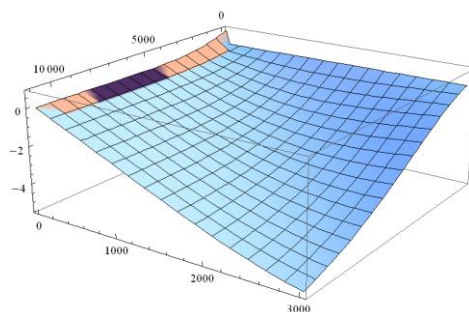

Figure 1. 3D view of distribution of the concentration of pollutants by described equation (1)

The monograph (Martinson, 2002) the two-dimensional case was analyzed. If within the square area  $\Omega$  there are sources which emit pollutants, where the dimensions  $L$  of the area are so large that the concentration of pollution on the borders of the area can be considered negligible. We analyze the case when the source of pollution can be described by a function  $Q(x, y, t)$ . In the diffusion approximation the non-stationary distribution of concentrations of air pollution  $u(t, x, y)$  is determined as a solution to the next boundary conditions (Berlyand, 1975):

$$\begin{aligned}
 \frac{\partial u}{\partial t} + v_x \frac{\partial u}{\partial x} + v_y \frac{\partial u}{\partial y} - D \Delta u - pu + Q(M, t) &= 0, \quad M \in \Omega; \\
 u(M, 0) &= 0, \quad M \in \Omega; \\
 u(P, t) &= 0, \quad P \in \partial \Omega, \quad t \geq 0.
 \end{aligned}
 \tag{8}$$

Here  $D$  is the turbulent diffusion coefficient;  $v_1, v_2$  - coordinates of wind speed vector  $v_0$ , which is considered a constant value;  $p$  - absorption coefficient of air pollution.  $M$  is a point inside the space  $M \in \Omega$ . The function  $Q(M, t) = \sum_{j=1}^N \varphi_j(t) \delta(M, M_j)$ ;  $\delta(M, M_j) = \delta(x - x_j) \delta(y - y_j)$  is the force by which the source ejects pollutants. In this case, the equation has an analytical solution of the following form (Martinson, 2002):

$$u(x, y, t) = \frac{4Q_0}{L^2} e^{-\frac{v_x(x-x_0) + v_y(y-y_0)}{2D}} \prod_{n=1}^N \prod_{m=1}^N \left(1 - e^{-\lambda_{nm} t}\right) \frac{\sin \frac{n\pi x}{L} \sin \frac{n\pi x_0}{L} \sin \frac{m\pi y}{L} \sin \frac{m\pi y_0}{L}}{\lambda_{nm}}
 \tag{9}$$

where

$$\lambda_{nm} = \frac{D\pi^2}{L^2}(n^2 + m^2) + \frac{v_0^2}{4D} + p \tag{10}$$

In the case where  $t \in \mathbb{A}$  the solution is obtained in the case of stationary sources. In addition to the analytical expression, a numerical solution can also be found. For the solution of partial differential equation in a rectangular field  $\Omega = \{(x,y): 0 \leq x \leq L, 0 \leq y \leq L\}$ , we used the Mathematica 8 software package. The sought function  $u(t, x,y)$  is numerically and graphically given in 3D. The density of pollution sources is described with the stationary function of the type  $Q(x,y) = \exp[-(x^2+y^2)]$ . If there was a solitary point source of constant power, for example  $Q(x, y, t) = Q_0 \delta(M, M_0)$ , where  $Q_0$  is a positive constant, the program would be unable to find the solution to the equation (8). The result of numerical calculation is given in Figure 2

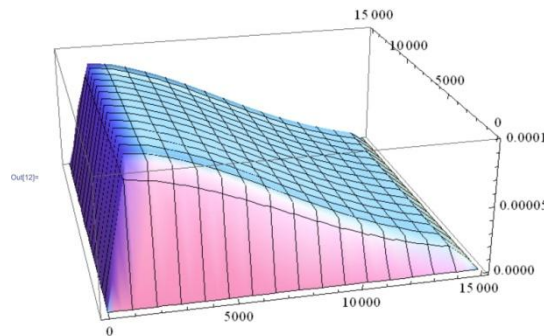

Figure 2. 3D shows the distribution of air pollution by described equation (8)

The semi-empirical equation of turbulent diffusion of the general form was analyzed by Stepanenko, Voloshin and Tipcov and it has the form (Stepanenko 2008):

$$\frac{\partial u}{\partial t} + v_x(t) \frac{\partial u}{\partial x} + v_y(t) \frac{\partial u}{\partial y} + v_z(t) \frac{\partial u}{\partial z} = k_x(t) \frac{\partial^2 u}{\partial x^2} + k_y(t) \frac{\partial^2 u}{\partial y^2} + k_z(t) \frac{\partial^2 u}{\partial z^2} - p(t)u(t) + Q(t)\delta(t - t_k)\delta(x - x_s)\delta(y - y_s)\delta(z - z_s) \tag{11}$$

In the above equation  $Q$  represents the mass of impurities which are separated at the moment  $t=0$  at the coordinate beginning  $(x_s, y_s, z_s)$ . Impurities are momentarily discharged at the moment  $t_k$ , the power of the source is  $Q(t_k)$ ;  $v_x(t)$ ,  $v_y(t)$ ,  $v_z(t)$  are the projections of the wind speed to the appropriate coordinate axes,  $\delta$  the Dirac delta function,  $p(t)$  speed of reduction (precipitation) of impurities over time, and  $k_i; i \in \{x, y, z\}$  are the turbulent diffusion coefficients. The turbulent diffusion coefficient depends on the meteorological conditions prevailing in the atmosphere at various distances from the ground surface. For simplicity, we will assume that their values are constant. The solution of the z-axis of the equation (11) possesses certain characteristics, since the vertical spread of impurities depends on the thermodynamic structure of the boundary layer of the atmosphere and the interaction of impurities with its boundaries. Therefore, for this equation boundary conditions are as follows:

$$k_z \frac{\partial u}{\partial z} + v_z u + \beta u = 0, \quad z = z_0 \tag{12}$$

$$\lim_{x,y \in \mathbb{A}} u(t, x, y, z) = 0$$

In (12)  $\beta$  is a parameter that characterizes the interaction of impurities with the ground surface. The basic dynamic parameter of the surface is the relief  $z_0$ , i.e. zero level from which the logarithmic wind profile is measured. The position of the lowest limit  $z_0$  coincides with the height of the relief layer.

When the impurities that precipitate are light, they interact with the surface and at the same time they either bounce off it  $\beta=0$  or are absorbed  $\beta \rightarrow \infty$ . These facts are taken into account when determining the vertical profile of the concentration of impurities.

The solution of the equation (11) for the stationary case  $Q(t) = Q = const$  takes the form (Stepanenko 2008):

$$u(x, y, z) = \frac{Q e^{\frac{v_x x + v_y y + v_z(z-h)}{2k_x + 2k_y + 2k_z}}}{4\pi \sqrt{k_x k_y k_z}} \times \left[ e^{-\frac{1}{2} \frac{x^2 + y^2 + (z-h)^2}{k_x + k_y + k_z} \sqrt{\frac{v_x^2 + v_y^2 + v_z^2}{k_x + k_y + k_z}}} + e^{-\frac{1}{2} \frac{x^2 + y^2 + (z+h-2z_0)^2}{k_x + k_y + k_z} \sqrt{\frac{v_x^2 + v_y^2 + v_z^2}{k_x + k_y + k_z}}} \right] + \frac{v_z + 2\beta}{k_z} \frac{Q e^{\frac{v_x x + v_y y + v_z(z-h)}{2k_x + 2k_y + 2k_z}}}{4\pi \sqrt{k_x k_y k_z}} \int_0^z e^{-\frac{v_z + 2\beta}{2k_z} \xi} e^{-\frac{1}{2} \frac{x^2 + y^2 + (z+h-2z_0-\xi)^2}{k_x + k_y + k_z} \sqrt{\frac{v_x^2 + v_y^2 + v_z^2}{k_x + k_y + k_z}}} d\xi \quad (13)$$

where  $\xi = \int_{t_k}^t k_x(t) dt$ .

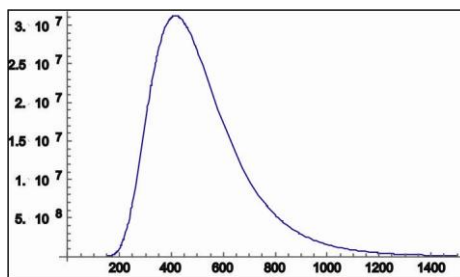

Figure 3. 2D distribution of concentrations of pollutants according to the solution of the equation (14)

In seeking a numerical solution of the equation (11) the following parameter values were adopted:

$$v_x = 4m/s; v_y = 2m/s; v_z = 1,3m/s; k_x = k_y = 0,115x^{0,73}; k_z = 0,034x^{0,73}; Q = 10^{12}; h = 34m$$

### The Gaussian Model

The simplest model for the calculation of ground-level concentrations of pollution is the Gaussian statistical model. In most countries, the models of this type are usually used in regulatory documents for the practical implementation of the assessment of air quality. In the base of this model lies the assumption that impurities emitted by a continuous point source form a column of smoke in which symmetrical distribution of the concentration of particles in relation to the axis of the column of smoke is observed. The basic equation of the Gaussian statistical model is composed of two probability density functions have the following form (Stepanenko 2009; Lazaridis 2011):

$$u(x, y, z) = \frac{Q f_F f_W}{2\pi \sigma_y(x) \sigma_z(x) \bar{v}} \exp\left(-\frac{y^2}{2\sigma_y^2(x)}\right) \exp\left[-\frac{(z-h)^2}{2\sigma_z^2(x)}\right] + \exp\left[-\frac{(z+h)^2}{2\sigma_z^2(x)}\right] \quad (14)$$

where  $Q$  is the mass flow;  $u$  - concentration of impurities in the given point of space;  $\sigma_y(x), \sigma_z(x)$  dispersions of diffusion in the direction of corresponding axes that depend on meteorological conditions which a particle covers from the source to the point with the  $x$  coordinate, whereby it is assumed that the direction of the  $OX$  axis coincides with the direction of the wind vector;  $\bar{v}$  - mean wind speed at the level of measurement;  $h$  - effective height of the source;  $f_F$  and  $f_W$  - corrections on the reduction of the cloud of impurities due to the dry precipitation of impurities.

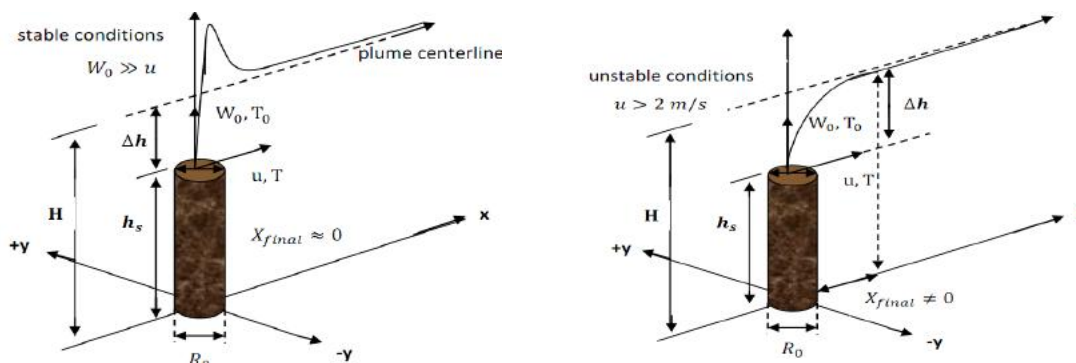

Figure 4. Graphic representation of the assumptions of expansion of air pollution at the Gaussian model (taken from Dragović 2012)

In the equation (14)  $\sigma_y$ ,  $\sigma_z$  are horizontal and vertical dispersion of impurities distribution. In order to determine these dispersions the following relations are used:

$$\sigma_y = Ax^a; \sigma_z = Bx^b \quad (15)$$

where  $A, a, B, b$  are the coefficients that depend on the stability of the atmosphere and surface relief and are determined experimentally.

Table 1: The parameters for dispersion calculation

		A	a	B	b			A	a	B	b
Very unstable	(A)	0,527	0,865	0,28	0,90	Neutral	(D)	0,128	0,905	0,20	0,76
Unstable	(B)	0,371	0,866	0,23	0,85	Stable	(E)	0,098	0,902	0,15	0,73
Slightly unstable	(C)	0,209	0,897	0,22	0,80	Very stable	(F)	0,065	0,902	0,12	0,67

For a demonstration of this model, we will observe the Smederevo iron and steel plant influence on air quality (average one-hour concentration). For this purpose the software used is SSREENVIEW 3.5.0, license number E474AA382E2AE61A by the US Agency for Environmental Protection. When calculating the concentration of sulfur oxides the following data were used:

1. Height of the chimney
2. The inside diameter of the chimney
3. The mass flow rate of flue gases at the outlet of the chimney
4. The temperature of flue gases at the outlet
5. The characteristics of the terrain around the iron and steel plant (rural and urban areas, altitude, topographic characteristics)
6. The state of the atmosphere in terms of stability and wind speed

Figure 2: adopted parameters for the calculation of SO<sub>2</sub> distribution

PARAMETER	ŽELEZARA SMEDEREVO (iron and steel plant)
Chimney height [m]	152
The inside diameter of the chimney at the outlet [m]	6,5
Flue gas temperature at the outlet	600
The mass flow of SO <sub>2</sub> [g/s]	200
Ambient temperature [ <sup>0</sup> K]	293
Gas velocity at the chimney outlet [m/s]	2,6

Based on the annual report of the Republic Hydrometeorological Service for 2015, stability classes F and D are dominant in Smederevo. The calculations took into account that the terrain is dominated by

lowland and plain properties. It was also noted that the Smederevo iron and steel plant is located in a rural area.

After the performed analysis, the results of the air pollution distribution are given in the following figure for the given parameters.

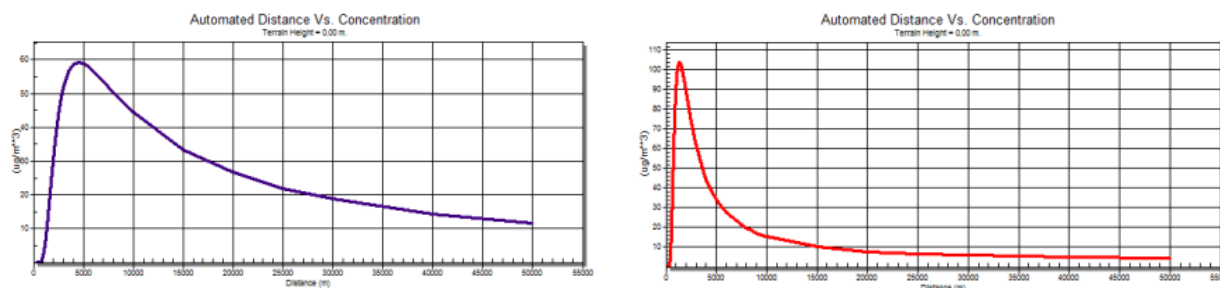

Figure 5. Distribution of  $SO_2$  concentration in the function of distance from the source for the stability class F (left) and stability class D (right) and the wind speed of 4 m/s

## CONCLUSION

The paper attempts to present some mathematical models dealing with the spread of air pollution. The process of the spread of air pollution is a complex problem due to the diversity of sources of air pollution and because there are different approaches to solving the problem. The use of the models depends on many factors related to the state of the atmosphere and geomorphological characteristics of the terrain on which the impurities spread. The paper covers the stationary and non-stationary sources, the models used being the Euler model and the Gaussian model. Due to the volume of the problem, neither air pollution from mobile sources nor the models used in the event of accidents emitting air pollution were not analyzed (e.g. the Pasquill-Gifford model). Furthermore, regulatory methodologies used in some for the analysis of the spread of air pollution were also not considered. From the considered models the most used one is the Gaussian model (being the simplest) for the analysis of the spread of impurities up to a distance of 50 km from the source. For the spread of impurities on longer distances the Euler approach is used. As can be seen from the above examples and graphical presentation of results, the models used give similar results. Since the spread of impurities through the atmosphere does not depend on the model used (and they give approximately the same results), it can be concluded that the models used are correct.

It should be noted that in addition to the use of mathematical models, the possibilities of information technologies are widely used today, especially the Geographic Information System (GIS), which is used worldwide to monitor and analyze air pollution in certain areas.

## ACKNOWLEDGEMENTS

This paper was supported by the Ministry of Education, Science and Technological Development of the Republic of Serbia no. TR 34019 and OI 171039.

## REFERENCES

1. М.Е.Берлянд, Современные проблемы атмосферной диффузии и загрязнения атмосферы, Гидрометеиздат, ст. 11-78, Ленинград, 1975.
2. М.Е.Берлянд, Прогноз и регулирование загрязнения атмосферы, Гидрометеиздат, ст. 8-79, Ленинград, 1985.
3. Dragović et.al., MATLAB Based Simulation of Dispersion of Air Pollutants from Industrial Sources, IT '12, pp. 108-111, Podgorica, ISBN 978-86-7664-102-4 (2012)
4. S.Jačimovski, S.Miladinović, V.Ilijazi, V.Zorić, I.Šetrajić, S.Armaković, J.Šetrajić, Linear expansion air pollution, Urban Eco, Ečka, 2012.
5. S.Jačimovski, J.Šetrajić, S.Miladinović, Distribucija aerozagađenja iz tačkastih izvora na primeru Železare Smederevo, Ecologica, Volume 23, No.82, pp.239 -243, ISSN0354-3285, 2016.

6. D.V.Kapor, S.D.Stojanović, M.J.Škrinjar, B.S.Tošić, The influence of Difusion on Air-Pollutant Distributions, Faculty of Sciences-University of Novi Sad, Review of Research, Volume 15, pp. 65-73, Novi Sad, 1985.
7. D.V.Kapor, M.J.Škrinjar, B.S.Tošić, The Three –Dimensional of Air-Pollutant Distribution, Faculty of Sciences-University of Novi Sad, Review of Research, Volume 13, pp. 59-70, Novi Sad, 1983.
8. M.Lazaridis, First principles of Meteorology and Air Pollutant, Springer, pp.201-232, New York, 2011.
9. Мартинсон Л.К., Малов Ю.И Дифференциальные уравнения математической физики, ст.186-189, МГТУ, Москва 2002.
10. Степаненко С.Н.,Волошин В.Г., Типцов С.В., Решение уравнения турбулентной диффузии для стационарного точечного источника, Украинский гидрометеорологический журнал, Но 3, ст. 13-25,2008.
11. Степаненко С.Н.,Волошин В.Г., Типцов С.В.,Новая формула оценки уровня загрязнения атмосферы промышленными выбросами, Украинский гидрометеорологический журнал, Но 4, ст. 227-237,2009.
12. B.S.Tošić,S.D.Stojanović, M.J.Škrinjar, D.V.Kapor, The one dimensional problem of air-pollutant distribution, Faculty of Sciences-University of Novi Sad, Review of Research, Volume 12, pp. 61-65, Novi Sad, 1982.
13. B.S.Tošić,S.D.Stojanović, M.J.Škrinjar, D.V.Kapor, Convection and Diffusion of Air Pollutants in Two Dimensions, Faculty of Sciences-University of Novi Sad, Review of Research, Volume 12, pp. 85-89, Novi Sad, 1982.
14. B.S.Tošić,S.D.Stojanović, M.J.Škrinjar, D.V.Kapor, General Theory of Three-Dimensional Air-Pollutant Distribution With Time dependent Parameters, Faculty of Sciences-University of Novi Sad, Review of Research, Volume 14, Novi Sad, 1984.
15. B.S.Tošić, S.D.Stojanović, Lj.D.Mašković, M.J.Škrinjar, J.P.Šetrajić, Propagation of the Air Pollutant in the Turbulent Atmosphere Abovethe Ground Layer, Faculty of Sciences-University of Novi Sad, Review of Research, Volume 18, pp. 41-46, Novi Sad, 1988.

## **MANAGEMENT OF SOLID URBAN WASTE**

V International Conference  
“ECOLOGY OF URBAN AREAS” 2016

**DEVELOPMENT OF SUSTAINABLE WASTE MANAGEMENT  
SYSTEM IN NOVI SAD WASTE MANAGEMENT CENTRE**

**Višnja Mihajlović\*, Mladenka Novaković**

Faculty of Technical Sciences, University of Novi Sad, Serbia  
visnjamihajlovic@uns.ac.rs, mladenkanovakovic@uns.ac.rs

**ABSTRACT**

*The complexity of the problems of environmental protection and waste management depends on a number of factors. The growth of municipal solid waste, rate of waste generation, disposal costs, environmental protection and health are few of the factors that have an impact on the improvement of solid waste management. Local communities in Serbia will face a problem of how to define, evaluate, optimize or adapt their waste treatment decisions and to meet the progress targets set at the European level. Implementation of waste treatment technologies and their relationship in order to meet the provisions of the directives depend on the environmental protection level that needs to be achieved and the future costs of the system. Implementation of biological treatment, composting and recycling of packaging and non-packaging waste can meet the European waste management targets at lowest costs.*

**Key words:** waste management, sustainability, waste treatment, costs, European waste management goals.

**INTRODUCTION**

Set of European Waste Management Directives, the Waste Framework Directive (EC, 2008), the Landfill Directive (EC, 1999) and the Packaging and Packaging Waste Directives (EC, 1994), will have a great impact on development of waste management system in waste management centers in Serbia.

Main deficiencies in solid waste management in Serbia are weak and inefficient law enforcement mechanism, fragmented inefficient organizational structures, lack or weak capacity or motivation of staff, lack of finances for investments, lack of incentives for both communal side and for the citizens. Dominant waste treatment method is still landfilling with high share of biodegradable municipal waste going to landfill, separate collection of waste is not established (Official Gazette of Republic of Serbia, 2010). Waste management in Serbia, is focused on waste collection and public health protection. Waste management centers in Serbia will have to develop waste management system in accordance with the Directives. Determination factor, will be estimation of waste quantities and their appropriate treatment. Experiences in development of waste management system and reaching the goals are different. Member States where the disposal of waste remained cheap, and where there are no fees and charges for waste disposal, the implementation of Landfill Directive and waste treatment technologies has been more slowly, unlike in countries where the implementation of the Directive on the landfill of waste, introduced fee for waste disposal, and thus gradually started to build the necessary infrastructure for waste management for example (Lasaridi, 2009; Stanic-Maruna & Fellner, 2012). In addition, in member states e.g. Poland, Bulgaria, Romania, Croatia still depend on landfilling and treatment options are rarely in place and therefore still a large amount of biodegradable waste is disposed of in landfills (Bipro, 2013).

Main focus of this paper is to identify the waste quantities, flows and cost of their treatment in order to meet the European waste goals.



## METHODOLOGY

Novi Sad is the second largest city in Serbia, with approximately 350.000 inhabitants and surface area of 701,7 km<sup>2</sup>. Novi Sad is one of the 26 regional waste management centers (Official Gazette of Republic of Serbia, 2010).

Morphological composition of municipal solid waste in Novi Sad is in Table 1. Data on morphological composition are obtained from several studies for the region of Novi Sad (Vujic *et al.*, 2010). Dominant fraction is biodegradable waste.

*Table 1: Morphological composition of waste in Novi Sad Waste Management Centers*

Waste category	%	tonnes
Garden waste	13	24737
Other biodegradable waste	33	62367
Paper	7	13704
Glass	6	10380
Cardboard	7	13666
Waxed cardboard	0.7	1408
Al-coated cardboard	0.9	1608
Metal- packaging and other	1	2371
Metal-Al cans	0.25	466
Plastic- packaging	4	8105
Plastic bags	6	11293
Hard plastic	4	8071
Textile	4	7497
Leather	0,5	1038
Nappies	3.6	6809
Fine waste particles	8	15569

Material flow analysis is chosen as a designing tool because it links waste inputs, products, residues, and allows for calculating the required plant capacities and residual flows (Stanisavljević & Brunner 2014). Technologies evaluated for waste treatment are used across the Europe, and are proven for the treatment of municipal solid waste (IPPC 2006a, IPPC 2006b, EC 1999).

Mass balance of analyzed technologies are given in table 2. (IPPC 2006a, IPPC 2006b, Alevridou et al. 2011; Stanisavljević & Brunner 2014)

*Table 2: Mass balance of waste treatment technologies*

Technology	Mass balance	Transfer coefficients
Composting	Compost	35%
	Residues	7%
	Wastewater	43%
	Off-gases	15%
Anaerobic digestion CHP	Biogas	15%
	Compost	30%
	Residues	7%
	Wastewater	48%
Incineration CHP	Bottom ash	26%
	Fly ash	4%
	Off-gases	70%

In general, it is very difficult to estimate the cost of a waste treatment plant and usually costs are estimated based on treatment plant capacity per year or as a total cost of the plant. Tsilemou & Panagiotakopoulos 2006 developed cost functions for capital (CAPEX) and operational (OPEX) costs for waste treatment at the European level (see table 3), which are used in this paper. Waste-to-energy technologies, incineration and anaerobic digestion with/without combined heat and power (CHP), are advanced technologies which are costly comparing to technically less demanding technology composting. Therefore, we have analyzed only composting and sanitary landfill and their costs and costs of reaching the European waste management goals.

Table 3. Approximate cost functions for waste treatment facility

Technology	CAPEX (€)	OPEX (€ tonnes <sup>-1</sup> )	Range (10 <sup>3</sup> tonnes year <sup>-1</sup> )
Incineration with CHP	$y = 5000 \times x^{0.8}$	$y = 700 \times x^{-0.3}$	$20 \leq x \leq 600$
Anaerobic digestion with CHP	$y = 35000 \times x^{0.55}$	$y = 17000 \times x^{-0.6}$	$2.5 \leq x \leq 100$
Composting	$y = 2000 \times x^{0.8}$	$y = 2000 \times x^{-0.5}$	$2 \leq x \leq 120$
Sanitary landfill	$y = 6000 \times x^{0.6}$	$y = 100 \times x^{-0.3}$	$0.5 \leq x \leq 60$
	$y = 3500 \times x^{0.7}$	$y = 150 \times x^{-0.3}$	$60 \leq x \leq 1500$

## RESULTS AND DISCUSSION

In 2035, total amount of generated municipal waste will be 322,769 tonnes with 2% increased rate. In order to comply with Landfill Directive, it would be necessary to treat 96,506 tonnes of biodegradable waste in composting plant. Regarding the goal of Packaging and Packaging Waste Directive, it would be necessary to recycle 36,712 tonnes of packaging waste. In addition, 28,165 tonnes of municipal waste would be necessary to recycle to comply with Waste Framework Directive. Residual waste, 168,140 tonnes which remain after separation of biodegradable waste, packaging waste and waste for recycling is disposed at sanitary landfill (see Figure 1).

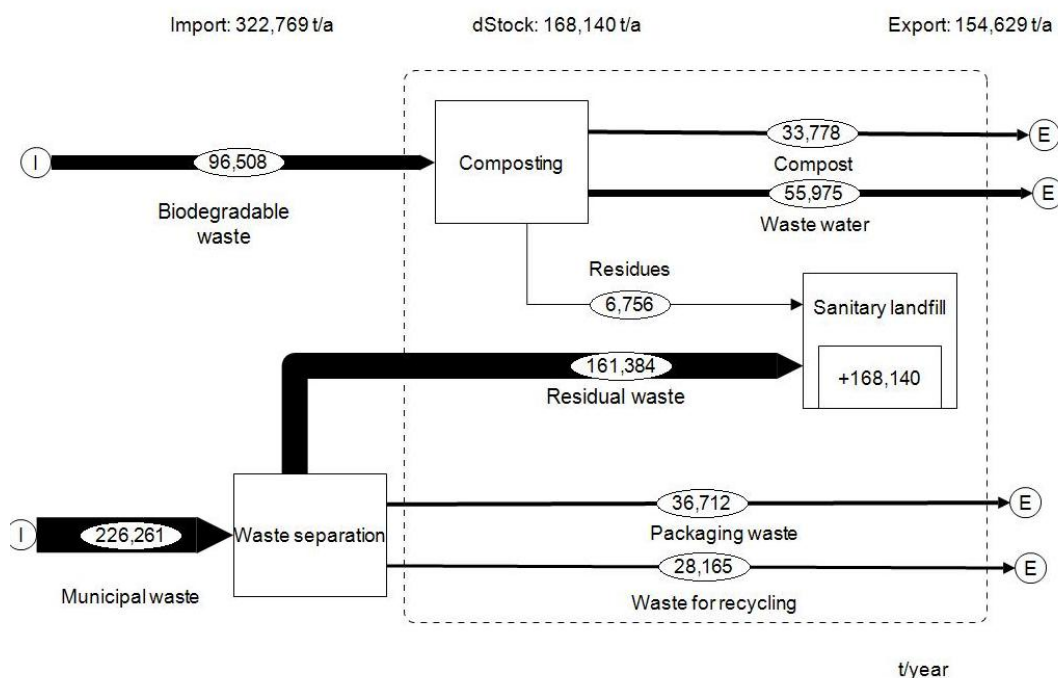

Figure 1: Material flow analysis

Sanitary landfill have the lowest cost per tonne of treated waste, and it is less desirable waste management option in waste hierarchy. Cost of the composting plant did not include the revenues

from compost and recyclables, which may reduce the overall cost. Implementation of the waste treatment technology is one of the most challenging task in development of the future waste management system.

*Table 4: Capital and operating costs of composting and sanitary landfill*

Technology	Waste quantity (t y. <sup>-1</sup> )	CAPEX (€)	OPEX (€)
Composting	96.508	19.439.281	11.838.866
Sanitary landfill	168.140	15.923.470	12.520.101
Recycling	64.877	-	-
Total costs		35.362.751	24.358.967

Implementation of analyzed waste management system will need the implementation and development of separate collection of biodegradable waste and recycles, which will increase the cost of the system. Successful implementation of waste technology and development of waste management system will need financial resources and efficient law enforcement mechanism, organizational structures and stronger enforcement mechanisms.

## CONCLUSION

Design of the waste management system in Novi Sad will face the increase of municipal waste quantities, and the need to manage it properly, in order to protect the health and environment. Fulfillment of the Waste Directives goals will be a main driver for the development of the future waste management system in Serbia (Wilson, 2009). This can be done through the strong commitment of the stakeholders and responsibility of local and national institutions in creating environment which will support the development of the well-functioning waste system. Without creating such an environment, implementation of waste treatments is hardly feasible, and cannot sustain in long term, as well as the whole waste management system itself.

## REFERENCES

- Alevridou A, Venetis C, Mallini D et al. (2001) Guidelines for development of alternative waste management, Project: Waste Network for sustainable solid waste management planning and promotion of integrated decision tools in the Balkan Region
- BiPRO (2013) Support to member states in improving waste management based on assessment of member states' performance 070307/2011/606502/SER/C2. Final report to the European Commission, Beratungsgesellschaft für integrierte Problemlösungen (BiPRO), Brussels, Belgium
- C.D. Wilson (2007) Development drivers for waste management. *Waste Management and Research* 25 (3) 198
- European Council (EC) (1994) Directive 94/62/EC on packaging and packaging waste, European Parliament and of the Council, Official Journal L 365, 20/12/1994, p. 10.-23., Luxembourg
- European Council (EC) (1999) Directive 1999/31/EC on the landfill of waste, European Parliament and of the Council, Official Journal L 182, 16/07/1999, p 1-19, Luxembourg
- European Council (EC) (2009) Directive 2009/98/EC on waste and repealing certain Directives, European Parliament and of the Council, Official Journal of the European Union L 312/3, 19/11/2008, p 3-30, Luxembourg
- I.Stanic-Maruna, J. Fellner (2012) Solid waste management in Croatia in response to European Landfill Directive. *Waste Management and Research*, 30(8), 825
- IPPC (2006a) Reference document on the best available techniques for waste incineration, European Commission - Integrated Pollution Prevention and Control
- IPPC (2006b) Reference Document on Best Available Techniques for the Waste Treatments Industries, European Commission - Integrated Pollution Prevention and Control
- K. Lasaridi (2009) Implementing the Landfill Directive in Greece: problems, perspectives and lessons to be learned, *The Geographical Journal*, 175 (4): 261
- Official Gazette of Republic of Serbia (2010) National Waste Management strategy for the period 2010-2019. Official Gazette 29/10

- Stanisavljević N & Brunner PH (2014) Combination of material flow analysis and substance flow analysis: a powerful approach for decision support in waste management. *Waste Management and Research* 32: 733-744
- Tsilemou K & Panagiotakopoulos D (2006) Approximate cost functions for solid waste treatment facilities. *Waste Management and Research* 24:310–322
- Vujić G, Jovičić N, Redžić N et al. (2010) A fast method for the analysis of municipal solid waste in developing countries – case study of Serbia. *Environmental Engineering and Management Journal* 9:1021–1029.

V International Conference  
„ECOLOGY OF URBAN AREAS“ 2016

**ENVIRONMENTAL IMPACT OF RECYCLING ACCUMULATORS  
AND BATTERIES WASTE**

**Žarko Vranjanac\***, Nenad Živković, Ljiljana Živković

University of Nis, Faculty of occupational safety in Nis, Serbia  
zarevranjanac@gmail.com; nenad.zivkovic@znrfak.ni.ac.rs; ljiljana.zivkovic@znrfak.ni.ac.rs

**ABSTRACT**

*The management of accumulators and batteries waste means the collection, transport, storage, selection, recycling and final disposal after treatment. Especially important part of managing this waste, in terms of environmental protection, is recycling. Environmental impact of recycling accumulators and batteries waste is reflected in the continuing pollution on landfills where the waste is due after the treatment, as well as irregular and illegal transportation, storage and uncontrolled recycling. The main pollutants that are contained in this waste are heavy metals like lead, mercury, nickel and cadmium, as well as sulfuric acid. In addition, during the recycling process the noise is generated, there are emissions of odors, particles of metal dust and organic compounds into the air and wastewater discharge into recipients after washing and cleaning facilities. This associated impacts are particularly pronounced when they are close to sensitive receptors, in the air, water and soil, which can cause permanent and serious consequences both for the environment and the health of children and people.*

**Key words:** *environmental impact, recycling, accumulators and batteries waste.*

**INTRODUCTION**

Increased use of accumulators and batteries, in many developed societies, had resulted with generating increasing volumes of this kind of waste. It is an essential factor for solving the impact of accumulators and batteries waste on the environment and human health. Some chemicals that are found in this waste can be found in the most remote places in the environment, animals and human beings. Economic growth, together with increasing industrialization follows a linear increase in the quantity of waste car batteries (Brunner P. and Fellner J., 2007.).

Inadequate management of accumulators and batteries waste represents a risk to human health and the environment (Inglezakis V. and Moustakas K., 2014.). Significant negative environmental effects, are especially expressed on the poorest members of the global community, as well as to vulnerable groups, women and children. It has been shown that accumulators and batteries waste containing certain chemicals that are contribute to the negative environmental impact. This negative impact is evident as a consequences that are reflected in the global and local level, starting from climate change to the degradation of nature and the contamination of air, soil and drinking water.

According to the information that are published in the report of the World Health Organization about the impact of chemicals on health, 5 million people a year lose their lives due to exposure to certain chemicals in the environment. The report warns that these figures are much higher because the chemicals are being used more and more, but there is a lack of research of their combined (cumulative) effect on the human body. According to this report, in the world die 5 million people because of the exposure to chemicals, which is 8.3% of the total number of deaths, and 86 million years of life is lost due to illness and disability caused by exposure to certain chemicals in the environment on annually base. By comparison, the number of years of life that the world population is lost for this reason, it is considerably larger than the number of years that are lost due to malignant disease (75 million years). Bearing in mind that this informations are given in the report for 2004, the

World Health Organization warns that the situation is even more dramatic, since the quantities of chemicals with negative effects increases steadily (Vranjanac Ž., 2015.).

A proper management of accumulators and batteries waste, as well as the recycling by the standards of the best available technologies (BAT) are crucial factors for ensuring the ecological balance. Based on the data of a technological characteristics for recycling accumulators and batteries waste, may be taken into consideration the impact of this waste on the environment. Consideration of the impact of accumulators and batteries waste, aims to determine (Vranjanac Ž., 2016.):

- sources of pollution and
- a mechanism of impact of this waste on the individual components of the environment (water, soil and air) and human health.

Based on this, measures and activities to minimize or eliminate the negative environmental and health impact of accumulators and batteries waste could be taken. Also, this paper work aims to draw attention to the need of carefully carrying out the recycling accumulators and batteries waste and at the same time need of controlling this process. While recycling is important for reducing the amount of waste, its illegal and improper use can lead to serious environmental implications (Brunner P. and Fellner J., 2007.).

## **RECYCLING OF ACCUMULATORS AND BATTERIES WASTE**

When they do become inoperative, lead and alkaline accumulators become the hazardous waste that requires special way of treatment. If the reduction at the source of pollution is not feasible, the next level is the reuse or recycling of hazardous waste. Recycling of accumulators and batteries waste, should be performed in a manner that is not harmful to the environment. In this way, it reduces the need for further treatment or disposal of waste in landfills, that can save an energy, water and other natural resources which results in the reduction of costs of managing this waste. This waste can be reused after recycling, returning the material to the reprocessing, mostly in the form of raw materials or simple commercial products (Jorgić R., Trumić M., 2004.).

According to the Law on Waste Management (Official Gazette of the Republic of Serbia, No. 36/2009, 88/2010 i 14/2016), recycling means any reuse operation by which waste is processed into a product, material or substance, regardless of whether used for the original or other purposes including reprocessing of organic material, except for reuse in energy production and reprocessing into materials that are intended for use as fuel or for covering landfills.

Recycling of accumulators and batteries waste, should be done according to the best available technologies (BAT), which ensure protection of human health and the environment. The choose of a provider who will carry out the recycling of waste accumulators and battery, need to have insurance that the plant is included in the standardized system of environmental protection.

In the treatment of wasted vehicles, waste from electrical and electronic products, and other equipment and devices whose components are batteries, it is necessary to separate the battery or accumulators from other parts. Recycling of accumulators and batteries waste must at least minimally to include the removal of all fluids and acids. Storage at installations for the treatment of waste batteries and accumulators, should be done at sites with impermeable surface, with adequate protection from weather conditions and in appropriate containers with lids (Stojanov A., Ugrinov D., 2010).

Recycling of accumulators waste is based on the neutralization of sulfuric acid and separation of lead, plastic and other materials that can be reused. Thus, the recycling of accumulators waste has 30% less used energy than the re-production of the battery is performed when the output of new raw materials.

Figure 1 (Jorgić R., Trumić M., 2004.) shows an overview of accumulators recycling where lead can be used in the preparation of new batteries, battery and for making ammunition, while the housing can

be reused after recycling to create new plastic products, also acid could be used in soaps and detergents, while the recyclable waste deposited at the registered dumps (eg. HW landfill in Zajača).

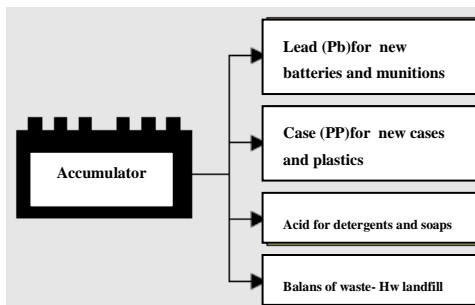

Figure 1. Overview of accumulators recycling

If performed in the manner prescribed, the primary role of recycling of accumulators is to protect health and the environment and preserve natural resources, through saving of raw materials and energy. The secondary role of recycling is the opening of new processing capacities, thus creating new jobs.

Transport of raw materials is carried out by trucks that have a license to transport hazardous materials such as acids in waste accumulators and batteries. Figure 2 shows a truck with a permit for the transport of hazardous waste and special types of containers in which are stored waste batteries. That way packed, accumulator waste is ready to be transported to recycling plants.



Figure 2. Truck and containers for storage of accumulators waste

Because of increasing importance which is reflected in the environment, in the manufacture of accumulators for contemporary designers and engineers as one of the most important demands is placed the accumulators recyclability at the end of its life cycle. In fact, manufacturers are forced to take into account the recyclability requirements, which means that batteries must be suitable for recycling. The process of recycling of accumulators depends on the structure of waste of accumulators recycling and applied technology. The structure of accumulator waste is shown in Chart 1 (Stojanov A., Ugrinov D., 2010.).

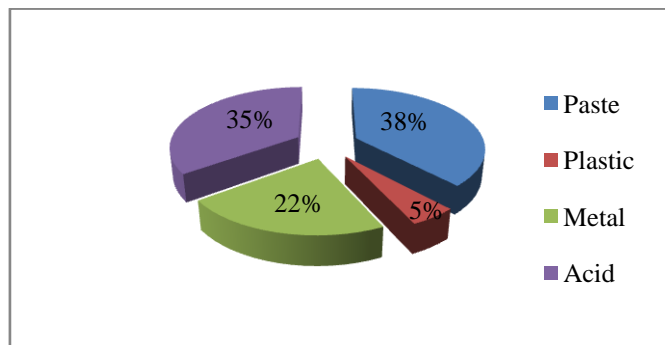

Chart 1. Structure of accumulators waste

Based on data from the Chart 1 it can be concluded that the basic composition of the battery is as follows:

- Paste - mass to charge accumulator plates, comprising PbSO<sub>4</sub> and PbO<sub>2</sub> in the ratio 1: 1;

- Plastic - insulation boards and plastic casing;
- Metal - metal parts with different contents of lead, mercury, nickel, cadmium and zinc, and
- The acid - sulfuric acid (H<sub>2</sub>SO<sub>4</sub>).

The most commonly used technological process during the recycling of waste batteries and battery is hydroseseparation. Hydroseseparation procedure is based on a highly automated process, where different companies find specific solutions when crushing, hydroseseparating, drying and post-treatment products of accumulators waste. Lead-acid accumulators contain two basic fractions, heavy (metals Pb, Pb-Sb alloy, sulfates and oxides) and light (plastic, ebonite, polyethylene, polypropylene, etc.). The essence of the hydroseseparation process is reflected in the fact that after crushing battery, these two fractions can be separated in the suspension of certain density. In the density of the suspension of 1800 kg / m<sup>3</sup>, the light and heavy fractions are separated in a hydrocyclone (Stojanov A., Ugrinov D., 2010.). In this way, the three products are obtained:

1. Pb-Sb alloy with 91-92% Pb,
2. oxide sulphate pastes and sludge with 62-68% Pb and
3. easy, non-metallic fractions.

In the Republic of Serbia, according to data from the Waste Management Strategy for the period 2010 to 2019th (Official Gazette of the Republic of Serbia, No. 29/10) annually is generated approximately 27,000 tons of waste lead-acid batteries and the entire amount is recycled. Precise data of the quantities of generated waste batteries do not exist. Used batteries usually end up on waste dumps, which indicates that there is no organized system for spent batteries.

## **ENVIRONMENTAL IMPACT OF ACCUMULATORS RECYCLING**

For the lack of an organized system of spent batteries in some locations there is soil contamination with lead, acid and plastic waste. Determining the movement of certain hazardous chemicals that come from waste car batteries, the environment is often complicated because of the fact that these same chemicals are found in nature. Once released into the environment, chemicals are involved in complex natural atmospheric, geochemical and biological cycles. Dispersion of waste chemicals in the environment takes place through several environmental segments, of which the most important are land, water, air and biosphere.

The trajectory of chemical movements from recycling accumulators and batteries waste in the environment is determined through soil and water, where it is through the food chain and aquatic organisms transmitted to man. Impact on air is defined as the impact of the plant and the recycling process and on the other hand can occur due to the release of toxic chemicals from waste. Scheme 1 shows the process of recycling of accumulators and batteries waste and environmental impact (Vranjanac Ž., 2016.).



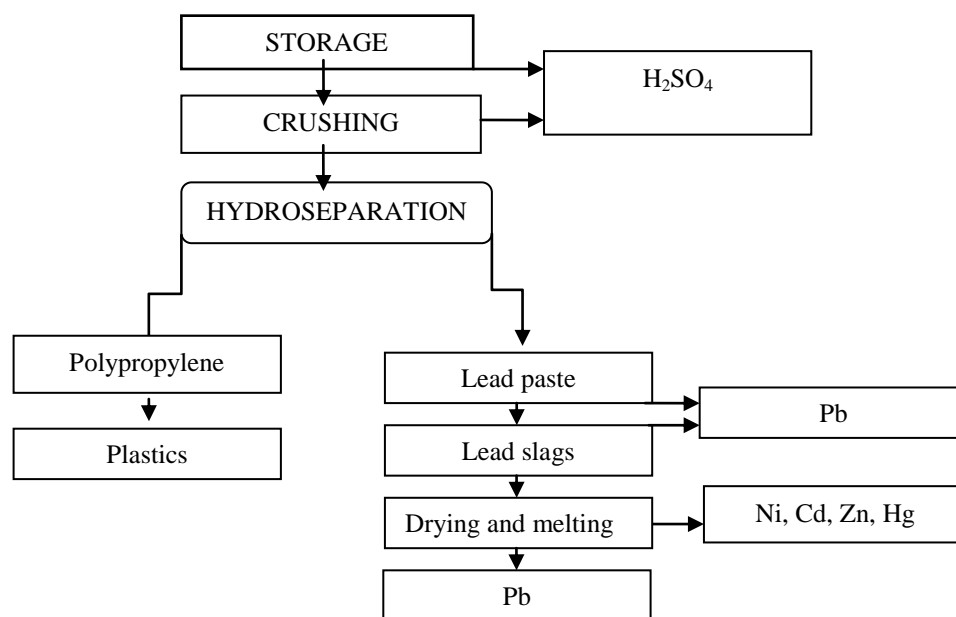

*Scheme 1. The process of recycling of accumulators waste and environmental impact*

Spent accumulators contain lead, mercury, nickel and cadmium, as well as sulfuric acid as the electrolyte, which is very aggressive and dangerous. The most common operations that are related to batteries and battery, in which the lead may be emitted into the environment are: storage, shredding and hydroseparation. Inadequate management of this waste, as well as the lack of a controlled process of recycling of accumulators and batteries waste, are the main sources of occupational lead poisoning and the release of lead into the environment (Inglezakis V. and Moustakas K., 2014.).

The deposition of lead in the majority of plants is more intense at the root compared to the aerial portions. On this basis, it can be concluded that there are significant risks to the environment and human health due to transfer in the food chain across the path of entry "soil-plant-human". Ingestion (swallowing) generated steames, fumes and dust of lead oxide after prolonged exposure can result in a chronic lead poisoning. Lead absorption may cause following toxic effects (Blagojević Lj., 2012.):

- hematological (anemia)
- neurological (paraesthesia, paralysis of arms, legs less often)
- gastrointestinal disorders (nausea, lead colic, diarrhea)
- disorders of renal function, reproductive system, cardiovascular, etc.

Sulfuric acid ( $H_2SO_4$ ) belongs to the group of strong inorganic acids. Environmental hazards from the recycling process of accumulators and batteries waste, related to the emission of sulfuric acid can be seen in the acidification of soil. After a long operation time acidification leads to a reduction in soil fertility and changes its buffering capacity. After land, sulfuric acid can enter into the aquatic ecosystems. It is very toxic to aquatic organisms, may cause long-term adverse effects in the aquatic environment. In contact with the skin or mucous membranes can cause them irritation and burns, if it comes into contact with the eyes causes damage. It is extremely corrosive and destructive to tissue, with the effect of acute toxicity by inhalation and ingestion. Lethal dose is about 6 to 8 g and death occurs usually after 18-24 hours of ingestion (Blagojević Lj., 2012.).

Mercury (Hg) is normally found in nature in organic and inorganic form. It can be transmitted from the recycling process of waste batteries and battery, if it comes to its expiration on the land and in the water. The most dangerous is mercury pollution of water that can easily accumulate in living organisms through the food chain, mostly through fishes. On the other hand mercury contamination of soil, for example, if it is used for irrigation with water which is contaminated with mercury from the

recycling process of waste batteries and battery, can lead to food of plant origin with a significant content of mercury. By entering into the blood, mercury reaches the bloodstream to all organs and accumulates in the liver, kidneys and brain (crosses the blood - brain barrier). At high acute inhalation exposure to inorganic living (inorganic mercury compounds are more toxic than organic) cause damage to the mucous membranes of the digestive tract, abdominal pain, bloody diarrhea and poisoning can be fatal ends due kidney failure. In the case of chronic exposure to lower concentrations occurs tremor, gingival inflammation, changes in behavior, depression, short-term memory loss, fatigue, loss of appetite and sleep disturbances (Blagojević Lj., 2012.).

Nickel (Ni), cadmium (Cd) and zinc (Zn) are integral parts of waste accumulators and batteries, and as such they can be found in the process of recycling to the environment. Cadmium and nickel are toxic metals that have the potential to contaminate the environment. Groundwater that are contaminated with nickel from the recycling process of waste batteries and accumulators, in its passage through the soil are collecting impurities that affect on their properties. Therefore, it is possible that, because of the terrain, due to their proximity to the sites of nickel, the cumulative effects of nickel occurs in significant concentrations in the drinking water. Long-term consumption of water 'enriched' nickel increases the risk of development of endemic nephropathy. The great similarity of cadmium ions with ions of zinc (zinc is an essential metal) could be replaced in enzymes which results in toxic effects. In acute poisoning dusts and fumes of cadmium occurs irritation and nose, respectively, upper respiratory tract, and may develop pneumonia with very severe clinical course and fatal outcome. In chronic exposure, an increase in binding of cadmium to metallothionein in all organs, primarily in the liver and kidneys, the bound form cadmium no toxic properties. In these organs cadmium slowly accumulates until it reaches a critical level and cause damage to health, to chronic poisoning. Chronic cadmium poisoning is characterized by renal impairment, respiratory organs, decreased bone density, which results in the occurrence of pain and frequent fractures. Cadmium adversely affects the organs of reproduction, has teratogenic properties and carcinogenic to humans (Blagojević Lj., 2012.).

According to the Regulations on emission limit values, methods and timeframe for measuring and recording data (Official Gazette of the Republic of Serbia, No. 30/97 and 35/97 - corr.) Limit value is the highest permissible level of the amount and concentration of harmful and hazardous substances on the site sources of pollution. As here are the most characteristic pollutant from the recycling process of accumulators and batteries waste, below it will be expressed their emission limits, Table 1.2 i 3.

*Table 1. Emission limit values (ELV) for installations for the production of primary and secondary lead-acid accumulators*

Type of substance	ELV(mg/m <sup>3</sup> )	for the mass flow above (kg/h)
Powdery substance	1	5
Gaseous sulfuric acid	1	-

Emission limit values for sulfuric acid and its vapor plant for the production of primary and secondary lead-acid accumulators is 1 mg / normal m<sup>3</sup>, for a powdery substance 1 mg / normal m<sup>3</sup> for mass concentration and 5 g / h for mass flow.

*Table 2. Types of carcinogens, their class, the limit value and the value of the mass flow*

Type of substance	Class	ELV (mg/m <sup>3</sup> )	for the mass flow above
Cadmium and its compounds - Cd	I	0,1	500 mg/h
Lead and its compounds - Pb	II	1	5 g/h

The total mass concentration of carcinogenic substances of the same class at the same time present in the exhaust gas is the highest: the matter of class I, 0.1 mg/m<sup>3</sup> at a mass flow of 500 mg/h and more; for substances of class II, 1 mg/m<sup>3</sup> at a mass flow of 5 g/h and greater.

Table 3. Types of powdery inorganic substances, their class, the limit value and the value of the mass flow

Type of substance	Class	ELV(mg/m <sup>3</sup> )	for the mass flow above (g/h)
Mercury and its compounds, expressed as Hg	I	0,2	1
Nickel and its compounds, expressed as Ni	II	1	5

The total mass concentration of powdery inorganic substances of the same class at the same time present in the exhaust gas is the most: the matter of class I 0,2 mg / m<sup>3</sup> at a mass flow of 1 g / h and higher; for substances of class II 1 mg / m<sup>3</sup> at a mass flow of 5 g / h and greater.

### The technological characteristics of the process of recycling accumulators and batteries waste

Due to the extreme recyclability and cost-effectiveness waste accumulators and batteries at the end of their life cycle subjected to the recycling process. This leads to the ecologically acceptable solution on the one hand, and economically viable on the other. However, this process must be environmentally friendly so recycling must respect certain standards, rules and procedures that will be discussed in the next chapter. In this paper, we will present the technological characteristics of the recycling process of waste batteries and accumulators, Table 4 (Stojanov A., Ugrinov D., 2010.).

Table 4. Technological processing parameters of the hydroseparation process of lead-acid accumulators

The product	Output (%)	Content (%)	Draw (%)
		Pb	
Larger Pb	16.0	91.35	23.84
Smaller Pb	17.3	89.26	25.23
Paste	21.1	71.01	24.50
Sludge	23.1	66.88	25.28
Boxes	15.1	2.37	0.58
Separators	7.4	4.73	0.57

On the basis of these data we can conclude that the composition of the waste battery according to the share weight of individual components is heterogeneous, and different parts contain certain amounts of lead, which can be extracted for reuse. It should be noted that the crushing of the battery is very hard work, because their composition includes different types of plastic whose grinding capabilities vary with the temperature. There is a problem with the grinding of metal parts that are prone to plastic deformation. Therefore products are large grinding grains that require the use of rugged devices for harsh environments. In Chart 2 shows the percentage composition of waste batteries prior to recycling processes, as well as the percentage of lead content and the draw after treatment.

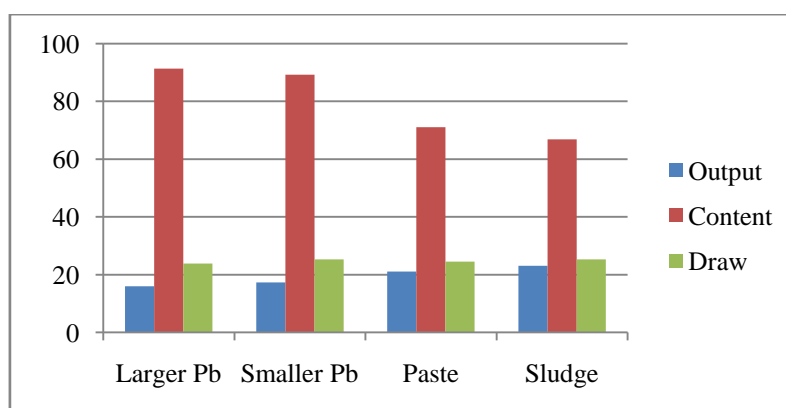

Chart 2. Percentage Distribution of waste batteries before recycling process (output), the percentage of lead content and draw upon recycling process

In further processing paste and oxides of waste batteries, in metallurgy there is a risk that the purified gases do not contain SO<sub>2</sub> and SO<sub>3</sub> in quantities greater than allowed, whose emission limit values shown in Table 5.

Table 5. Emission limit values for installations for melting slags in waste gas

Type of substance	Type of plant	ELV (mg/m <sup>3</sup> )	for the mass flow above (g/h)
Sulphur oxides SO <sub>2</sub> and SO <sub>3</sub>	Melting slags	1.800	10

### The quantities of accumulators and batteries waste

Table 6 and Chart 3 shows data on the quantities of generated waste of accumulators and batteries, their disposal, treatment, import and export in Serbia in the period from 2010 to 2014th (Report on the State of the Environment of the Republic of Serbia., 2011- 2014).

Table 6. The generated amount of accumulators and batteries waste, disposal, treatment, import and export to Serbia in the period from 2011 to 2014th in tons

Year	Generated waste	Disposed waste	Treated waste	Exported waste	Imported waste
2011	790	0	5295	0	0
2012	1562,90	/	18322,41	2282,80	1952,90
2013	1632,19	/	14059,55	4988,33	303,85
2014	751,57	/	1913,81	183,79	/
<b>Total</b>	<b>4736.66</b>	<b>0</b>	<b>39590.77</b>	<b>7454.92</b>	<b>2256.75</b>

On the basis of these data we can conclude that the Republic of Serbia in the period from 2011 to 2014th generated a total of 4,736.66 tons of accumulators and batteries waste. According to the information on the treatment, export and import of waste batteries and chargers could be concluded that processed and exported significantly greater amount of waste, which indicates the existence of inventory, cost effectiveness of treatment and the specificity of time using this product. In the analyzed period there were no data on delayed or deposited quantities of waste batteries.

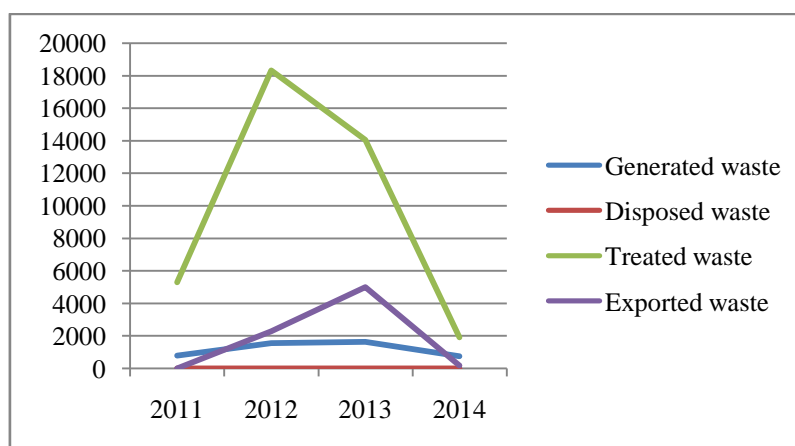

Chart 3. Trends in generated quantities of accumulators and batteries waste, disposal, treatment, import and export to Serbia in the period from 2011 to 2014th in tons

The Chart 3 clearly shows that the largest quantities of accumulators and batteries waste go to treatment, that is, in the analyzed period, recycled 39,590.77 tons of this waste. Such a high degree of recycling of accumulators and batteries waste, indicates that it is necessary to assess the influence of the process of recycling of accumulators and batteries on the environment.

## CONCLUSION

Due to the extreme recyclability and cost-effectiveness accumulators and batteries waste are subjected to the recycling process. This leads to the ecologically acceptable solution on the one hand, and economically sustainable on the other. However, making the recycling process to be environmentally friendly must be complied with certain standards, rules and procedures according to best available tehnics (BAT) requirements.

Based on the above it can be concluded that the process of recycling of accumulators and batteries waste, has a significant impact on the environment and human health. This is primarily the result of inadequate management of this waste, while on the other hand the emission of pollutants can occur from uncontrolled recycling processes (Inglezakis V. and K. Moustakas, 2014). In both cases there is a discharge of lead, sulfuric acid, nickel, cadmium, zinc and mercury into the environment and therefore to the entry of these pollutants in the body of living beings.

The negative effects that are manifested in the environment are most pronounced at the ground, water and air, where it meets the cumulative effects of these pollutants. It causes imbalance in the environment, which is reflected in the reduction of pollution and soil fertility, contamination of surface and groundwater, serious consequences for the biosphere and thus the man, causing a number of adverse health effects that may end fatally.

It is noteworthy that the current problem is not adequately analyzed, so far in the literature and practice little attention has been paid to reviewing the negative impact of the recycling process of waste batteries and accumulators on the environment. Therefore, structured paper like this, provides a starting point for further research on the environmental impact of recycling accumulators and batteries waste.

## REFERENCES

- Blagojević Lj. (2012). *Životna sredina i zdravlje*, Fakultet zaštite na radu, Niš, p.213-215.
- Brunner P. and Fellner J. (2007). Setting priorities for waste in developing countries, *Waste Management & Research*, Vol. 25, p. 234-240.
- Inglezakis V. and Moustakas K. (2014)., Household hazardous waste management, *Journal of Environmental Management*, p. 310-321.
- Izveštaj o stanju životne sredine (2011-2014), Agencija za zaštitu životne sredine, Beograd.
- Jorgić R., Trumić M. (2004). Reciklaža akumulatora, *Ekološka istina*, Kopaonik, p. 3-4.
- Pravilnik o graničnim vrednostima emisije, načinu i rokovima merenja i evidentiranja podataka ("Sl. glasnik RS", br. 30/97 i 35/97 – ispr)
- Stojanov A., Ugrinov D. (2010). Problematika prikupljanja i reciklaže istrošenih olovnih akumulatora, *Zaštita materijala*, Beograd, p. 245.
- Strategija upravljanja otpadom za period 2010. – 2019. godine, (Sl. glasnik RS br. 29/10)
- Vranjanac Ž. (2015.). Ekonomsko-ekološki uticaj otpada od higijenskih sredstava na životnu sredinu, Master rad, Fakultet zaštite na radu u Nišu, Niš, p. 45-65.
- Vranjanac Ž. (2016.). Upravljanje zaštitom životne sredine u procesu reciklaže otpadnih akumulatora i baterija, Seminarski rad, Fakultet zaštite na radu u Nišu, Niš, p. 12-33.
- Zakonu o upravljanju otpadom ("Sl. glasnik RS", br. 36/2009, 88/2010 i 14/2016)

V International Conference  
„ECOLOGY OF URBAN AREAS“ 2016

**SUSTAINABLE TECHNOLOGIES IN RECYCLING OF MOTOR  
VEHICLES, ELV**

**Milan Pavlović<sup>1\*</sup>, Miroslav Vulić<sup>1</sup>, Slavko Arsovski<sup>2</sup>, Aleksandar Tomović<sup>3</sup>**

<sup>1</sup>Technical Faculty “Mihajlo Pupin”, University of Novi Sad, Serbia

<sup>2</sup> Faculty of Engineering, University of Kragujevac, Serbia

<sup>3</sup>Faculty of mechanical engineering, University of Belgrade, Serbia  
milanpavlovic50@gmail.com; miroslavvulic@live.com

**ABSTRACT**

*Recycling of motor vehicles today presents itself as a generator of development and entrepreneurship in the world, both from the economic and technological development on the side of the market, and from the aspect of environmental protection. Developing sustainable technologies for recycling of motor vehicles at the End of the Life Vehicle (ELV), achieving multiplier effects, which are related to environmental protection, sustainable use of natural resources, energy conservation, intensive employment of labor, improve economic performance and achievement of significant profits, as realization of sustainable development of the entire automotive industry. The paper presents the economic, environmental and socio-economic viability of recycling ELV technology, with emphasis on legislation of European Union (EU) and the Republic of Serbia (RS).*

**Key words:** *sustainability, technologies, recycling, ELV, environment.*

**INTRODUCTION**

ELV presents a big source of environmental pollution but if it is use on the right way, it could be a great source of material resources, especially metals. That implies recycling of ELV and reusing of materials which is obtained like that. Considering on the economical and technological development in many markets which requiring the need for increasing amounts of material resources, such ELV treatment is of increasing importance.

Recycling of ELV have economic, environmental and socio-ecologic contribution. ELV recycling process brings considerable savings in materials and energy and represents a profitable branch of industry. Beside that, with reusing components which are derived from recycling ELV process, significantly contributes to the reduction in the rate of exploitation of natural resources.

**LEGISLATIVE ASPECT**

**Directive 2000/53/EC**

The European Union has recognized the importance of ELV and 18 September 2000 adopted the Directive 2000/53/EC (Directive 2000/53/EC) which refers to the vehicle at the End of the Life Vehicle. The Directive lays down measures to reduce the generation of waste from motor vehicles, increase reuse of parts and recycling levels, all in aim for reducing the impact of ELV on the environment. Such an approach to waste management is a concept 3R, respectively reduce, reuse, recycle (Simić, M., Pavlović, M., Tomović, A., & Pavlović, A., 2013).

The essence of the EU's policy in dealing with the ELV means efficient and cost-effective recycling system.

The directive requires measures which are aimed at preventing waste from ELV and reuse, recycling and other forms of reconstruction, in order to reduce waste disposal and environmental improvement

through the work of all participants involved in the life cycle of vehicles, especially those involved in the treatment of ELV.

The technical-technological and other conditions that all participants in the treatment ELV must fulfill is prescribed, which is verified by the competent state institutions, but defined reporting and monitoring.

Also, companies engaged in collecting and processing ELV must provide all the necessary instructions and information that will facilitate recycling. Manufacturers must, throughout the concept and design of the vehicle to take care of the possibilities for reuse, recycling and energy recovery through incineration of unusable waste and must take a report about that (Pavlović, M., Čepić, Z., Karanović, N., & Stajić, T., 2009).

### **Sustainable development strategy RS**

RS Government adopted the National Strategy for Sustainable Development (Službeni glasnik, br. 57/08) May 2008. The aim of the National Strategy for Sustainable Development is to bring balance to the three pillars, three key dimensions - economic growth, environmental protection and social balance creating a coherent whole, supported by appropriate institutional framework. This strategy significantly reduces the gap between the process of determining policy, harmonization of some conflict policy objectives, as well as determining their mutual advantage. This includes integration and harmonization of objectives and measures of sectoral policies, harmonization of national legislation with EU and their full implementation. It also includes goals to reduce formation of waste and construction waste management infrastructure, adoption of regulations and regional and local waste management plans. The Government also adopted the Action Plan for the Implementation of the National Strategy for Sustainable Development, in March 2009 (Strategija upravljanja otpadom za period 2010.-2019. godine.).

### **ECONOMIC SUSTAINABILITY**

Recycling industry as a whole is very diverse and includes a wide range of services and productive economic activities, ranging from waste collection and processing, to those who provide reuse of used parts or provide new products from recycled materials (Pavlović, M. Karanović, N., & Đurić, A).

ELV represent a major source of environmental pollution, but if it's used it the right way, it can be a great source of material resources, especially metals. This includes the recycling of ELV and reuse of raw materials thus obtained material resources. With regard to economic and technological development in many markets, requiring the need for increasing amounts of material resources, such treatment of ELV has all magnified character.

Demand for spare parts is the main source of revenue recycling of used cars. Satisfying this demand offers core business mission of most companies. In size, the other source of income from recycling, is the demand for ferrous metal waste which represents economic incentive to companies engaged in collecting or disassembling the vehicle. Nearly 100 percent of ferrous metal scrap is to be repaired. Market demand for raw materials obtained by recycling of ELV directs the success of this industry (Pavlović, M. Karanović, N., & Đurić, A).

With achieving economic effect, protection of the environment involves the collection, processing, distribution, storage and management with vehicle waste and its elements from generation to reuse.

With model of integrated and sustainable recycling of motor vehicles at the end of the life cycle in Serbia, which are set basis for the development of new industries, thus creating real conditions for intensive employment in the business of recycling. These activities include collection and transportation of waste motor vehicles, dismantling them, selection of components and materials,

recovery of components for reuse, crushing shells and chassis, the separation of materials, recycling materials, disposal of final waste. All this requires a different structure of professional staff, a variety of recycling technologies and different composition of objects and relevant requirements for their location.

The creation of these industrial sector would create conditions for employment of a significant number of workers in jobs of collection, transport, handling, dismantling, etc. (Arsovski, S., Milivojević, J., Grubor, S., Kokić Arsić, A., & Tonić, N).

Quality work leads to improvements and increases of reparations components that could be released for reuse.

## **ECOLOGICAL SUSTAINABILITY**

Besides the economic benefits of recycling system of used motor vehicles, not less important - the fact in favor of benefits of developing a recycling system, as well as its development in Serbia is to contribute to protect the environment.

Motor vehicles with their components, metal parts and toxic fluids that reach the End of the life cycle are significant polluters of the environment (Vulić, M., Tomović, A., & Pavlović, A., 2015).

Motor vehicles that have reached the ELV's beside scrap metal which forms a major part, contain a large quantity of various liquids.

### **Detoxification**

To successfully recycling process of motor vehicle precede adequate detoxication and treatment of toxic waste from vehicles such as fuels, motor oils, oils from gearshifts, oils from differential, hydraulic oils, antifreeze, acids from the accumulator, liquids from air-conditioner (Pavlović, M., Karanović, N., & Đurić, A., 2011). Only after their safe removal from the car, it can be accessed to further recycling process to other parts of the car, which states that each center for the recycling of cars in the country should have the right equipment for detoxification of hazardous liquids (Pavlović, M., Arsovski, S., Ćurčić, S., Milovančević, M., Tolmač, D., & Tomović, A., 2013).

The process of detoxification itself takes place in the following order:

1. Registration of vehicle data at the end of the life cycle
2. Start the process of detoxification vehicles
3. Remove the battery, airbags and pyrotechnic means resources
4. Remove the wheels / tires, the wheel balancer lead

After completing the preparation, vehicle is set in a specially designed equipment (mobile or stable) which is used for process of removing fluid and other items.

5.
  - removal of fluids (fuel, engine oil, transmission oil and brake system oil, antifreeze, refrigerant from air conditioners and washer fluid)
  - removing the catalyst, the oil filter and removing all the parts that are labeled as hazardous (mercury switches and such like.), see fig. 1.

After successfully done detoxication the vehicle is lowered from the device designed for mentioned purpose.



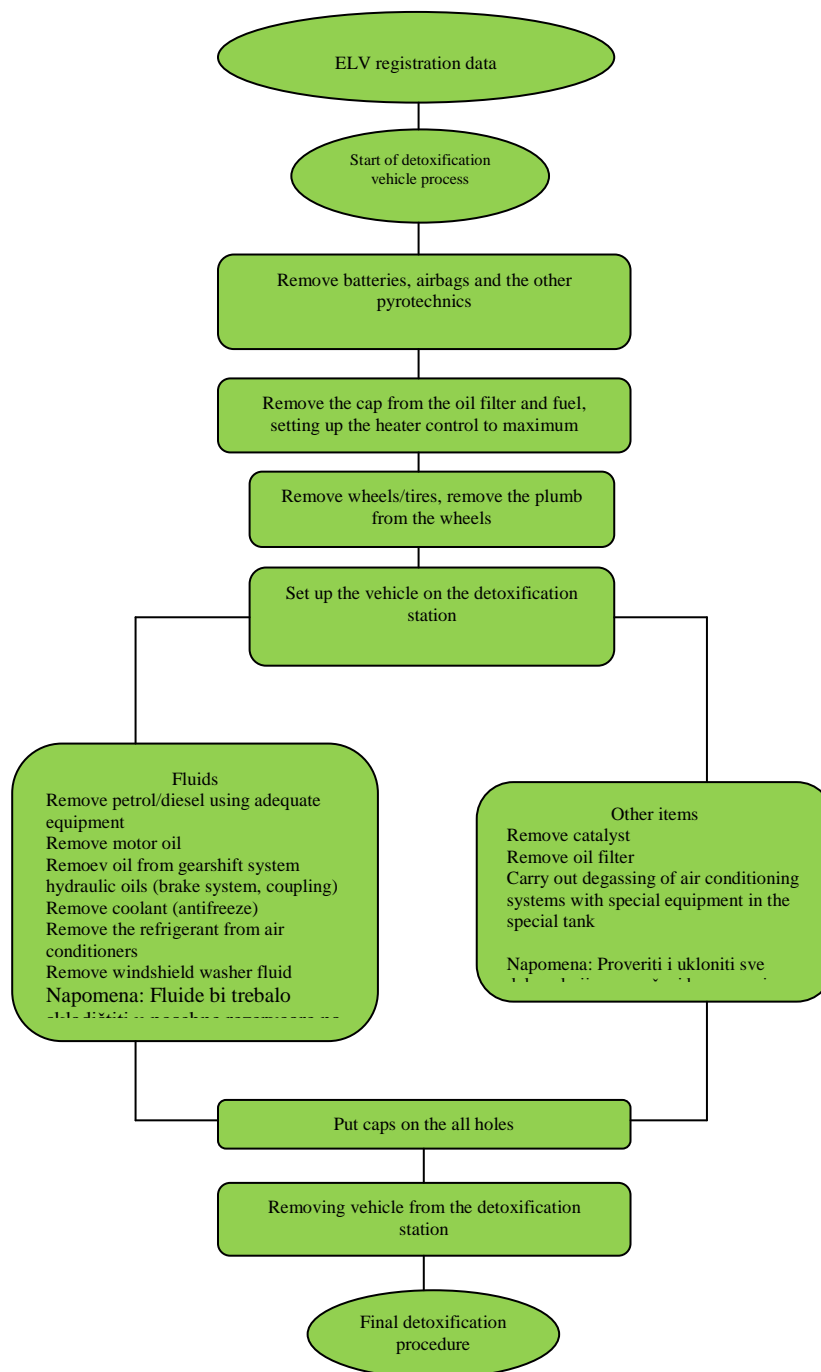

Figure 1. Diagram of detoxification process (Pavlović, M., Karanović, N., & Đurić, A., 2011)

Detoxification process itself is not economically viable and therefore sustainable, but from aspect of the environment is very important process.

## CONCLUSION

The minimization of waste in all stages of life of the motor vehicle tends toward sustainability. With developing scientific researches over and technical centers in order of analysing the impact of recycling motor vehicles, forming a network of centers for the collection and dismantling, as well as the forming of an integrated network of centers for recycling waste materials (iron and steel,

nonferrous metal and fluid, residual fuels, rubber, plastic, batteries, etc.) are stages which lead to socio-economic sustainability recycling of ELV.

## ACKNOWLEDGEMENT

This paper is a result of the research activities conducted under the project TR 35033, which is financed by the Ministry of Science and Technological Development of Republic of Serbia.

## REFERENCES

- Pavlović, M., Karanović, N., & Đurić, A. (2011). *Uputstvo za detoksikaciju motornih vozila na kraju životnog ciklusa u skladu sa pozitivnim zakonodavstvom Republike Srbije - deo projekta „Postavljanje održivog modela reciklaže motornih vozila u Banatu u skladu sa novim nacionalnim zakonodavstvom“*
- Vulić, M., Tomović, A., & Pavlović, A. (2015). Development of technology of existing equipment for discharging brake fluid in the process detoxification of ELV. *Journal of Production Engineering*, 18(2), 60-64.
- Pavlović, M., Arsovski, S., Ćurčić, S., Milovančević, M., Tolmač, D., & Tomović, A. (2013). *Постројење за уклањање течности из возила на крају животног циклуса – прототип*. Технички факултет „Михајло Пупин“, Универзитет у Новом Саду.
- Pavlović, M., Karanović, N., & Đurić, A. Izveštaj o realizaciji projekta: *Postavljanje održivog modela reciklaže motornih vozila u Banatu u skladu sa novim nacionalnim zakonodavstvom*.
- Pavlović, M., Čepić, Z., Karanović, N., & Stajić, T. (2009). *Razvoj integrisanog i održivog sistema reciklaže motornih vozila pri kraju radnog veka*.
- Directive 2000/53/EC of the european parliament and of the council on end-of life vehicles, OJ L 269, pp. 34, October 2000.
- Simić, M., Pavlović, M., Tomović, A., & Pavlović, A. (2013). *Tehno-ekonomska analiza opreme za reciklažu motornih vozila na kraju životnog ciklusa, S-kriva*. Festival kvaliteta, A-442-A450.
- Službeni glasnik, br. 57/08.
- Strategija upravljanja otpadom za period 2010.-2019. godine*. Službeni glasnik RS, br. 55/05, 71/05 – ispravka, 101/07 i 65/08.
- Arsovski, S., Milivojević, J., Grubor, S., Kokić Arsić, A., & Tunić, N. *Uticao modela integrisane i održive reciklaže motornih vozila na kraju životnog ciklusa na naivo zaposlenosti u Srbiji*.

**WATER QUALITY IN URBAN AREAS (GROUND WATER,  
DRINKING WATER, WASTE WATER AND FACILITIES)**

V International Conference  
„ECOLOGY OF URBAN AREAS“ 2016

**BACTERIOLOGICAL MONITORING AND WATER QUALITY OF  
DANUBE RIVER AT BUDAPEST TERRITORY**

**Hosam BAYOUMI HAMUDA**

Óbuda University, Rejtő Sándor Faculty of Light industry and Environmental Protection Engineering, Institute of Environmental Protection Engineering, Budapest, Hungary  
bayoumi.hosam@rkk.uni-obuda.hu

**ABSTRACT**

*Faecal coliform bacteria are present in water when bacterial pathogens from faecal contamination are present. The bacteriological parameters used for monitoring the quality and eco-status of the River Danube surface water in Budapest were examined according to the Hungarian Standard Methods. The basic bacteriological indicators are investigated once a month throughout June, August and October in 1998, 2005, 2010, 2011, 2012, 2013, 2014 and 2015 at five different sites on the Danube River run throughout Budapest in three replicates per site. The analysis of the results showed noticeably lower quality on 2015 comparing with the earlier years throughout the entry and exist points of the Danube River into Budapest. The results recorded changes in bacterial contamination in Danube surface water samples. The bacteriological analyses indicated that Escherichia coli, total coliform, Pseudomonas aeruginosa and enterococci reached to above 300, 200, 200 and 300 CFU/ml, respectively at summer season. The bacterial indicators composition was related to changes in environmental conditions and eco-physicochemical parameters. Results were realized a small, non-constant, and unstable correlation between enteric bacteria and some eco-physicochemical parameters. These correlations were not sufficiently consistent to establish a reliable association; therefore, this study corroborates that only the bacterial assay itself is reliable for the diagnosis of faecal contamination by enteric bacteria in the collected surface water samples.*

**Key words:** Bacteriological contamination, monitoring, Danube River, Budapest territory, surface water quality.

**INTRODUCTION**

Surface water is more vulnerable to pollution than ground water resource especially in developing countries where the heavy industrialization, increasing urbanization, and adaptation of modern agricultural practices play an important role in improving the living standard but at the same time cause severe environmental damage (Mulk et al., 2015). Tu (2013) reported that human activities associated with land uses can cause surface water degradation. Nutrient loading into rivers is generally increased by human-induced land-use changes and can lead to increased surface water pollution. With the optimistic estimate; one in four people could not be reached to adequate drinking water in 2050. One of the most important factors that will determine humanity's future quality of life within the scope of the environmental pollution is water pollution, and it is updated day by day with more important. Water quality is a concept that includes taste, odour, colour, appearance, softness, temperature and bacteriological and chemical characteristics, and it is being affected by climatic and meteorological changing as well. Water quality in the Danube has improved during the last decade, but further improvement is still needed. Most stretches of the Danube can be described as moderately polluted, but some tributaries and stretches of the lower Danube fail to achieve this status. In some areas harmful substances from farmland and heavy industries pollute the rivers and severely undermine the quality of the water.

Monitoring the Danube's environment with biological and chemical systems is absolutely essential to identify human health and ecosystem hazards, to assess environmental clean-up efforts, and to prevent further degradation of this ecosystem. Adequate supplies of fresh water of acceptable quality are a prerequisite for human health, food security, industrialization and economic development. Danube River represents an important touristic and economical resource. Danube River is the second largest river in Europe after the Volga River. Danube River flows 2,860 km with a total area of 801,463 km<sup>2</sup>. The river rises in the Black Forest Mountains of Germany and flows eastward into the Black Sea. It is an important international waterway, flowing through or forming a part of the borders of ten countries and through major cities such as Vienna, Bratislava, Budapest, and Belgrade. Geographically (Figure 1) the river basin includes the territories of 19 countries: Germany (Baden-Württemberg and Bavaria), Austria, Czech Republic, Slovakia, Hungary, Slovenia, Croatia, Bosnia and Herzegovina, Montenegro, Serbia, Bulgaria, Romania, Moldova and Ukraine, with catchment areas larger than 2000 km<sup>2</sup>; and Switzerland, Italy, Poland, the Former Yugoslav Republic of Macedonia and Albania with smaller areas. Danube region is heterogeneous area in the economic, ecological and cultural aspects and inhabited by 83 million. Hungary is located at the “meeting point” of weather fronts but overall has a moderate climate with strong continental influence. Seasons are usually well defined, with July and August averaging 28-32°C and December and January down in average to about -5°C. Annual precipitation is 600 mm with ranges of 300-1200 mm; while evapotranspiration rates are similar at 500-600 mm/year. Hungary is located in the lowest part of the Carpathian Basin, 84% of the country lies below 200 m, with only 2% above 400 m and river gradients are generally low.

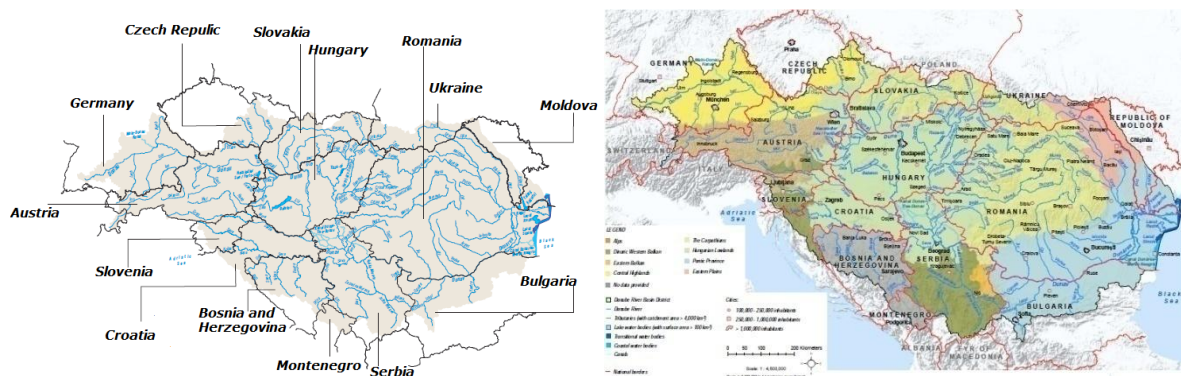

Figure 1. Map of the Danube River Basin Ecoregions in 2015 (*Maps of the Danube River Basin District Management Plan*).

According to the International Commission for the Protection of the Danube River (ICPDR, 2014), the largest environmental investment to be implemented in Central Europe will fundamentally modernise the wastewater treatment system of Budapest, ensuring cleaner waters for all those living along the banks of the Danube. The Hungarian Danube traverses 417 km, forming the border with Slovakia in the North-West and thereafter flowing south. In the east, also flowing southwards is the Tisza, covering 595 km before reaching Serbia where it later flows into the Danube (ICPDR, 2014). The investigation of changes of the surface water quality is one of the major questions of environment protection. Extreme floods occurred in June 2013 on the upper and lower Danube River and the strength and intensity of this flood event reminded to floods in 2002. Since Danube River is among the most endangered ecosystem in Europe, there is urgent demand for comprehensive methodological approaches to evaluate the actual state of this ecosystem and to monitor its rate of changes. Danube Day was held annually on 29 June is an international day honouring the Danube and the rivers that

flow into it, paying tribute to the vital role they play in providing water, food, power, recreation and livelihood. Environmental health and water quality are important determinants of human health, especially the water borne diseases in local communities like the bacterial contamination of surface water of Danube River in Budapest territory remains a central local and global problem. In cities where inefficient sewage system, the domestic wastewater discharge (Figure 2) is one of the main sources of pollution, stimulating the growth of bacteria and adding other microorganisms to the environment, including those found in faecal matter (Silva et al., 2010). Danube River ecosystem contains lot of various types of animals and plants; from fish and ducks to tiny water beetles and worms, and from algae to water plants as well as the planktons (zoo-, phyto- and bacterioplanktons).

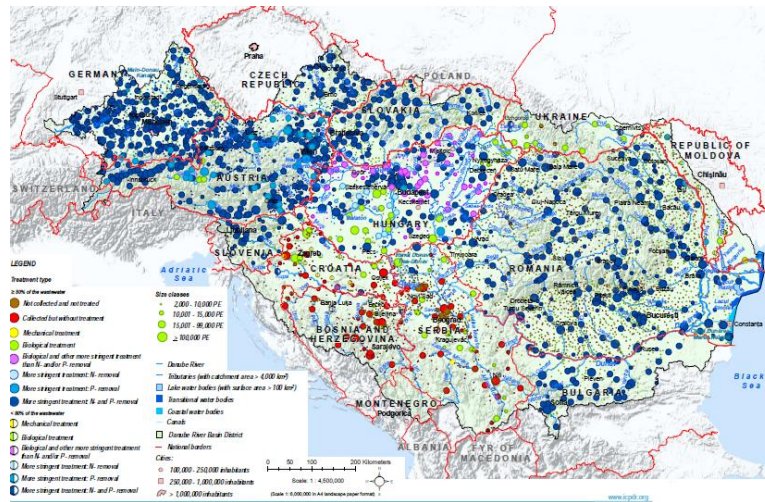

Figure 2. Map of the Danube River Basin District. Urban Wastewater Discharges: Baseline Scenario – Urban Waste Water Treatment Directive (UWWT) 2015).

Analysis of eco-physicochemical (Figures 3a, b, c) and bacteriological parameters of water is essential to assess water quality for the best usage. Public and environmental health protection requires safe water, free of pathogenic bacteria. Among the pathogens disseminated in water sources, enteric pathogens which are the most frequently encountered. The sources of faecal pollution in water due to anthropological activity must be strictly controlled and the most significant factors that affecting water quality of Danube River Basin are organic, nutrient, hazardous substances, and microbial pollution, alterations due to the hydro-morphological pressure (Gasparotti et al., 2013).



Figure 3a. Nutrient Pollution: Nitrogen



Figure 3b. Nutrient Pollution: Phosphorus



Figure 3c. Vulnerable zones

Figure 3. Map of the Danube River Basin District: Nitrogen, phosphorus and nitrate status in vulnerable zones during 2015.

Drainage basins of most affluent have the same predominant lithology of the Danube course, probably with a greater contribution from sedimentary lithologies (Comero et al. 2014). Water quality in Danube River basin is under a great pressure due to the diverse range of the human activities including large urban centre, industrial, agriculture, transport and mining activities.

Faecal microbial pollution is a major problem throughout the Danube River Basin, posing a threat to various types of water use, including drinking water production from river bank filtrates, water supply for agricultural and industrial use, and the role of the river as a recreational space. It is introduced into the river by point sources, such as discharges of treated or untreated sewage from anthropological sources or livestock, and by nonpoint sources, such as urban and agricultural runoff. Higher levels of faecal pollution were found in the middle part of the Danube, particularly downstream of major cities (Budapest, Beograd) as far as 1.100 river km and in the Lower Danube to the Danube Delta (Kavka et al., 2006). In addition, faecal input from wildlife may be of importance in specific regions. Despite huge efforts to improve wastewater management in the past decade, in many sections, the river and its tributaries exhibit very high levels of faecal microbial pollution. The main groups of bacteria used to indicate pollution levels in water are total and faecal coliform, and more specifically *Escherichia coli*, has been indicated to evaluate the anthropogenic contamination of a wellspring (Silva et al., 2010). Total coliform and faecal coliform indicator tests are common public health tests of the safety of water and wastewater which might be contaminated with sewage or faecal material (APHA, 1998). Most coliforms are present in large numbers among the intestinal flora of anthropological and other warm-blooded animals, and are thus found in faecal wastes. As a consequence, coliforms, detected in higher levels than pathogenic bacteria, are used as an index of the potential presence of entero-pathogens in water environments. Coliform includes members of the family Enterobacteriaceae. Pathogenic organisms are normal species of all ecosystems, but microbiological contamination with faecal bacteria is considered to be a crucial issue throughout the rivers (Bayoumi Hamuda & Patkó, 2012).

Microbiological contamination from faecal pollution is considered to be a crucial problem throughout the Danube River basin imposing a threat to all kinds of water uses (Kirschner et al., 2007; 2009). Thus, detailed knowledge on the extent and origin of microbial faecal pollution is crucial for watershed management activities in order to maintain safe water use according to the quality targets. *Escherichia coli* and intestinal enterococci are used worldwide as bacterial indicators for the assessment of faecal pollution in the aquatic environment. *Escherichia coli* bacteria are shown to be a consistent predictor of gastrointestinal illness. Enterococci concentration has been shown to be a reliable factor in explaining rates of gastrointestinal illness in swimmers exposed to faecal

contaminated coastal water and to be related to acute febrile respiratory illness (WHO, 2003). According to the new EU Bathing Water Directive (European Parliament & Council, 2006), assessment of microbiological bathing water quality of designated surface waters is exclusively based on these two bacterial faecal indicator groups. The use of total coliforms as indicators of faecal pollution in surface waters in international regulations has been abandoned in recent years because of the discovery that certain species belonging to this group are not of faecal origin (Gauthier & Archibald, 2001). However, this group was – beside faecal coliforms, enterococci and salmonellae – included in the former EU Bathing Water Directive (EC, 1976), which was the valid basis until 2007 for all countries of the European Union. To assess microbiological water quality, indicators of faecal pollution are used as surrogates for the potential presence of intestinal pathogens. However, the standard indicators cannot provide any reliable information regarding the origin of faecal pollution, nor can their concentration levels be directly related to human health risks for many types of exposure and situations (Kirschner et al., 2015). For the microbial quality test of any water source, faecal contamination indicator organisms are preferred as the approach is fast and cheap (APHA, 2005). While a variety of pathogenic indicators have been proposed; the mostly commonly used estimator of faecal pathogenic bacteria presence is faecal coliforms and faecal streptococci abundance (Ford & Colwell, 1996). Other useful indicators include intestinal enterococci.

Attempts to comprehensively monitor bacteriological quality in large, international rivers have been tackled by a number of organisations in Europe. For the River Danube, the only large-scale bacteriological investigation published to date deals with the changes of bacterial community composition along the whole river (Winter et al., 2007). The combination of the faecal indicator data sets of the two Danube surveys (JDS 2001, 2007) with major environmental parameters and the integration of long term observations at 16 representative sampling stations enabled us to draw for the first time a clear picture of the faecal pollution patterns along the longitudinal profile of this important international river. With a novel microbial source tracking approach, it was recently shown that about 70% and 80% of *E. coli*/FC variation observed during JDS 2001 and JDS 2007 in the tributaries could be explained by a faecal human specific *Bacteroides* marker (Reischer et al., 2007). In comparison to Budapest and Bucharest, *E. coli* concentrations downstream Vienna was 25 times and 425 times lower, respectively. Surprisingly, no such increase could be observed for example after Bratislava. Farnleitner et al. (2010) concluded that *E. coli* and enterococci are reliable faecal indicators for alpine mountainous water resources monitoring, although *E. coli* is the more sensitive one and suggested a conservative microbial source tracking marker for anthropogenic faecal influence.

One main reason for this observation is likely that during both Joint Danube Surveys samples were taken only from the middle of the river. In large rivers like the Danube, wastewater or highly polluted tributaries produce a sewage plume on the respective side where they merge, which is not mixed with the main river water for tens of kilometres. Water of Danube River Basin could be chemically, physically, or bacteriologically contaminated. Each of which is linked to various sources and health related problems and consequences. Two main factors determine the chemical and bacteriological conditions of water quality: artificial and natural contamination. Any bacteriological or chemical analysis of water reveals the joint effects of both sources of contamination, and it is usually impossible to fully identify and separate these sources. Kittinger et al. (2015) reported that the stretch of the River Danube between Vienna, Bratislava and Budapest passes a region that is highly industrialized, intensively used for agricultural purposes and also highly populated. The elevated values may indicate these influences. This study set out to evaluate the occurrence of some enteric bacteria in surface water samples of Danube River at Budapest territory, and its relation to some eco-physicochemical parameters. So, the purpose of this monitoring effort is to monitor and evaluate the changes in surface



water quality resulting from changes in environmental changing practices. The work also, is to summarize the historical biomonitoring in Danube River surface water quality during the period between 1998 and 2015, and to determine the faecal bacterial pollution status of the Danube River at Budapest territory.

## **MATERIALS AND METHODS**

To make sure that the investigated water samples of Danube River in Budapest region were representative, the water samples were taken from the Pest and the Buda sides of the river's bank at every sampling location. Water samples were collected in June, August and October of 1998, 2005, 2010, 2011, 2012 and 2013 from five locations: Rákóczi, Petőfi, Szabadság, Erzsébet and Árpád bridges with three replicates. All samples for physical, chemicals and bacteriological analysis were collected in (~ one litre capacity) sterile dark bottles without air bubbles and immediately placed on dark cooling boxes and processed within 6 h of collection. Temperature, pH and electroconductivity were measured according to the Hungarian standards (MSZ EN 27888:1998, MSZ 448-22-1985 and MSZ EN 27888: 1998, respectively) immediately after the water samples were collected. The chemical (COD<sub>Mn</sub>) and biological (BOD<sub>5</sub>) oxygen demands were detected by MSZ ISO 6060-1991 and MSZ ISO 5815-1998, respectively. The bacteriological quality of surface water was carried out according to the Hungarian method: MSZ 12749:1993. Total and faecal coliform bacteria: MSZ ISO 9308-2-1994 and MSZ ISO 5541-1 (1994). Detection of *E. coli*: MSZ 448-44-1990 in comparison with ISO 11866- (1997). *Enterococcus* sp.: MSZ 12749-1993. Counting the total aerobic mesophile heterotrophs was carried out by MSZ ISO 6610 (1993). Different cultural media were used for the isolation of different faecal indicator organisms were carried out using the membrane filtration method: this is based on the filtering, under negative pressure, of the water sample through a cellulose acetate membrane with a porosity of 0.45 µm and connecting with glass filtration unit. Bacteria are retained on the filter, which is then placed on a suitable nutrient medium. Bacterial colonies growing on the medium can then be counted. When a selective or differential medium is used, desired colonies will have a distinctive appearance. Total aerobic mesophile heterotrophic bacteria were enumerated by standard plate count (tryptone glucose yeast agar) by serial dilution of the sample, followed by the conventional spread plate method (Chen & Kueh, 1976) and the colony count were measured after incubation at 37°C for 24 hr. Detection and enumeration of *E. coli* and coliform bacteria were done on Endo Agar. Typical coliform colonies count pink to dark red colonies with metallic sheen. Atypical coliform colonies Count dark red or nucleated without metallic sheen. Detection and enumeration of intestinal enterococci on Brain heart infusion agar. Detection and enumeration of *Pseudomonas aeruginosa* was done on modified M-PA Agar and Cetrimide-agar. Colonies appear as brownish to green black centres on filters. Eosin Methylene Blue agar, MacConkey agar and m-Endo agar were used to count the total and faecal coliforms, *E. coli* and *Enterobacter*. Enumeration of cellulose decomposers was done by using carboxymethylcellulose (CMC) agar medium. One ml of serial dilution of Danube water sample (10<sup>-5</sup>) was spread over the CMC agar plate and cultivated at 28 ± 2°C for 3 days. The plate was flooded with 0.1% Congo red for 15 to 20 min, washed with 1 M NaCl for 15-20 min, and observed for clear zone around the colony (Hendricks et al., 1995). The clear zone formed around the bacterial colonies is used as indicator for cellulase activity. The bacterial population was expressed in term of log<sub>10</sub> of the CFU/100 ml.

## **RESULTS AND DISCUSSION**

The Danube territory is a major international water catchment area and ecological corridor. Therefore, a nature conservation, territorial development and water management approach is needed. The environmental impact of transport links, tourist developments, or new energy-producing facilities must also be considered. Major flooding, droughts, and industrial pollution events are all too frequent. Prevention, preparedness and effective reaction require a high degree of cooperation and information sharing. With current increasing trends in population growth and socio-economic development, the quality and quantity of water is gaining widespread attention worldwide. This increasing concern

about water quality and quantity necessitates the interventions in water systems to meet the objective of sustainable water supply and prevent potential environmental deterioration. Water could be chemically, physically or bacteriologically polluted. Each of which is linked to various sources and health related problems and consequences. The major factors determine the chemical and bacteriological consist of water quality: artificial and natural pollution. The results of monitoring of some physical, chemical and bacteriological parameters of the surface water samples along Danube River in Budapest region are presented in the average of 3 replicates of 5 investigated sites on both sides of the river basin during June, August and October in 1998, 2005, 2010, 2011, 2012, 2013, 2014 and 2015 are presented in Figures 4, 5, 6, 7 and 8.

Physical and chemical parameters: The values are favourable to growth of microorganisms which could have contributed to high total coliform count as observed in this study. Water temperature in this study ranges between 19.55°C (1998) to 24.2°C in 2015 (Figure 4a). This was found to be within the permissible limit of the world health organization (WHO, 2003). Water bodies will naturally show changes in temperature seasonally and daily; however, man activities can also contribute to changes in surface water temperature. The high temperature could also be as a result of urban, industrial and agricultural activities around the River. The temperatures observed were higher than 18°C in all the locations and all through the various months which favour the growth of bacteria. Aquatic organisms are sensitive to changes in water temperature and it is an important water quality parameter which is relatively easy to measure. Temperature also influences the rate of photosynthesis by algae and aquatic plants. As water temperature rises, the rate of photosynthesis increases thereby providing adequate amounts of nutrients (Boulton, 2012). The temperature values obtained throughout the investigation period fall within the optimal growth range for mesophilic bacteria including human pathogens. The results illustrated that pH value (Figure 4b) of all the water samples range from 7.32 in the monitoring year 2011 to 7.95 in 2005. Generally, the pH values obtained fell within the WHO standard of 6.5-8.5 (WHO, 2003). There was no significant difference between the pH values for the three months in all the collection points at  $P < 0.05$  significant level. According to the pH values obtained, majority were in the trend of slightly alkaline. Therefore, the water samples were unlikely to cause health problems such as acidosis (Asamoah & Amarin, 2011).

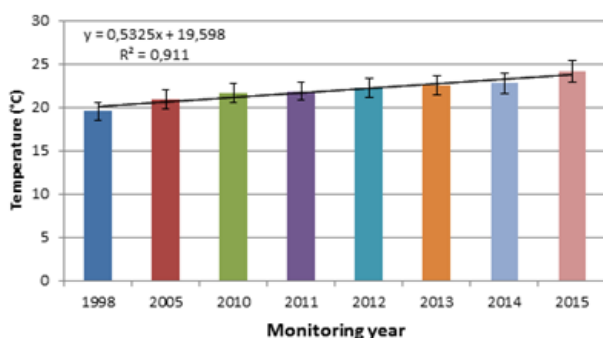

Figure 4a Temperature

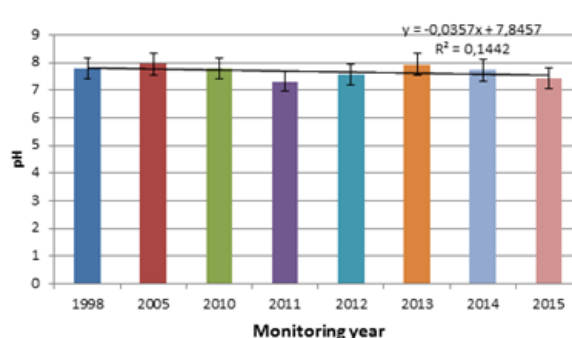

Figure 4b pH

Figure 4. Monitoring the average temperature and pH in Danube River at Budapest city

However, pH played a significant role in determining the bacterial population growth. Increases in the observed pH, could be attributed to the production of basic metabolic waste products by increasing bacterial population. Prescott et al. (1999) stated that microorganisms frequently change the pH of their own habitat by producing acidic or basic metabolic waste products. Electroconductivity is the degree to which a water sample can carry an electric current. The magnitude of the electroconductivity of a sample is a function of the amount of ions present in the sample. High electroconductivity can be

an indicator of excessive mineralization from either natural or industrial sources. The results indicated that the electroconductivity of water samples were ranged between 328.1 in 2010 and it was at maximum (35.2 m/Sm) in 2014 (Figure 4a). Turbidity typically composed of fine clay or silt particles, plankton, organic comp compounds and microorganisms. Sources include erosion, storm water runoff, industrial discharges, microorganisms, and eutrophication. Monitoring of turbidity is an important criterion of water. The turbidity profile varied throughout the study period and ranged from 36.9 in 2010 to reach the maximum 56.1 mg/l in 2005. The Month of June had the highest turbidity level while the lowest was recorded in the month of October. The high level of turbidity could be due to industrial effluents, improper disposal of sewage, animal waste and wastewater from domestic activities among others.

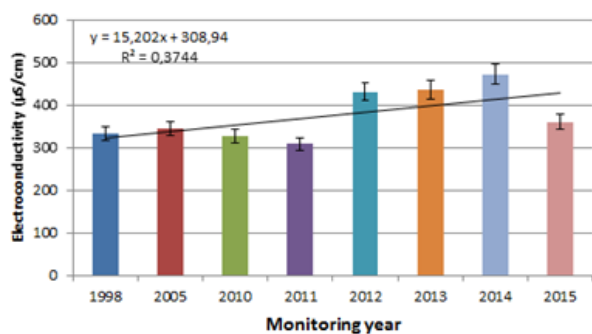

Figure 5a Electroconductivity

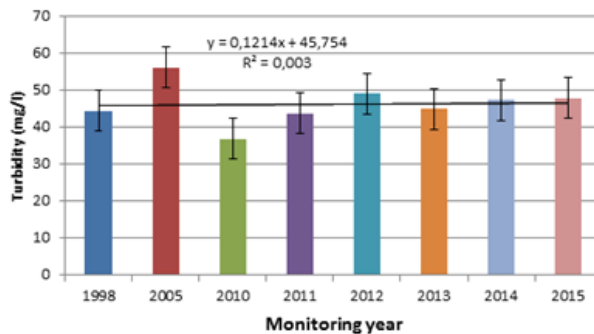

Figure 5b Turbidity

Figure 5. Monitoring the average electroconductivity and turbidity in Danube River at Budapest city

The  $COD_{Mn}$  values ranged from 2.17 mg/l in 2011 and 4.42 mg/l in 2013 (Figure 5a). High  $COD_{Mn}$  values could be due to high organic loading resulting in high total solid materials within the water body.  $COD_{Mn}$  differs from BOD in that it measures the  $O_2$  demand to digest all organic content, not just that portion which could be consumed by biological processes.

Figure 5b highlights the result so presented for  $BOD_5$  which indicates the amount of organic waste in the water and measure of the  $O_2$  used by microorganisms to decompose this waste. Growth of aerobic and facultative anaerobic bacteria will be enhanced by the presence of dissolved oxygen in any water body. A decrease in dissolved oxygen was generally observed in 2012 with 1.91 and 3.63 mg/l in 2013. WHO (1996) reported that there is tendency for the level of  $BOD_5$  values range from 10.00 to 35.89 mg/l. All the values of  $BOD_5$  in the river samples are lower than the permissible standard the WHO standard of 50 mg/l for waste water. The more organic material presents in the river the higher the  $BOD_5$ .

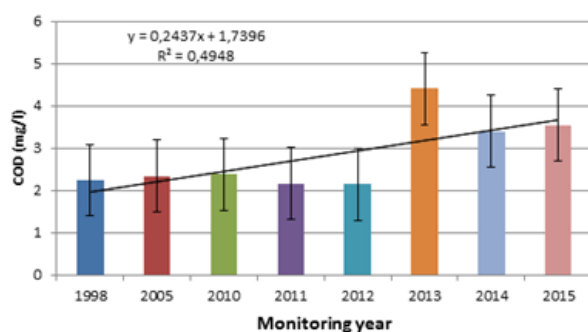

Figure 6a COD

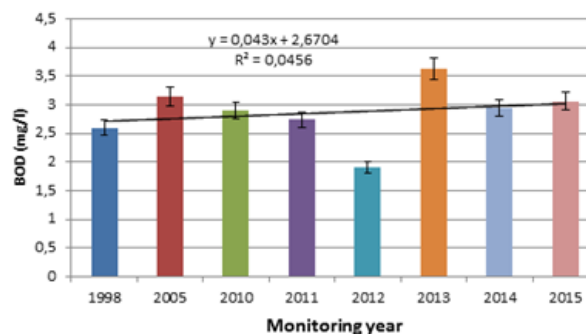

Figure 6b BOD

Figure 6. Monitoring the average COD and BOD in Danube River at Budapest city

Bacteriological parameters: The number of bacterial colonies can be influenced by weather and seasonal effects. This variability makes the bacterial concentrations in natural water difficult to predict at any one time. The WHO standards for total and faecal coliforms are 1 to 10/100 ml and 0/100 ml, respectively (WHO, 2003). The results in Figures 7 and 8 revealed that all the water samples had very high counts of total and faecal coliforms which could be attributed to human and animal activities on the river because coliforms are of intestinal origin. Therefore, a potential health risk exists due to their presence in water and the result is in agreement with Poonkothai & Parvatham (2005) in India that revealed the presence of bacteria at high concentration in automobile wastewater. Industrial waste and the municipal solid waste have emerged as one of the leading cause of pollution of surface and ground water in many parts of this country, thus available water is rendered non-potable because of the presence of industrial effluents and high microbial contamination.

The bacteriological assessments expressed in the term of log<sub>10</sub> of the colony forming unit showed that the total counts of aerobic mesophile heterotroph bacteria and the total coliforms were gradually increased from 1998 and reach the maximum in 2015. It was found that this group of bacterial population is changed from 4.66 (log<sub>10</sub> of CFU/100 ml) in 1998 to 7.97 in 2015. Coliform bacteria have long been used to indicate faecal contamination of water and thus a health hazard. The population of total coliforms was increased gradually from 4.34 (1998) to reach 5.52 in 2015. Meanwhile, the population of faecal coliforms was changed to be the lowest in 2013. Similar indication was obtained by *Enterococcus* that it was lowest in 2013 with 1.913 and highest in 2005 with 2.95. The highest log<sub>10</sub> value of *E. coli*/ 100 ml was found during 2005 season (2.04), followed by the 2011 (1.76), 2010 (1.47), 2012 (1.45), 2013 (1.38) and 1998 season (1.37). The measured bacteriological indicator parameters provided a consistent picture of faecal pollution in the Danube River in Budapest region throughout the investigation periods. Highest enterococci population was observed in 2005, followed by 2010 and 1998.

Faecal indicators were all highly significantly intercorrelated in the investigated periods. The lowest population was recorded with *Enterobacter* sp. Followed by the faecal *Streptococcus* sp. and *P. aeruginosa*. The population of cellulose-decomposers was higher than *E. coli* and lower than *Enterococcus*.

Figure 8 shows that the ratio between total coliforms and total aerobic mesophile heterotrophs was at lowest value in 1998 with 0.749 and the highest was in 2012 to 1.385. Also, the ratio between the faecal coliforms and total coliforms was at highest in 2005 and the lowest value was detected in 2013. The ratio between *E. coli* and total coliforms had the similar pattern as in case of the ration between faecal coliform and total coliforms.

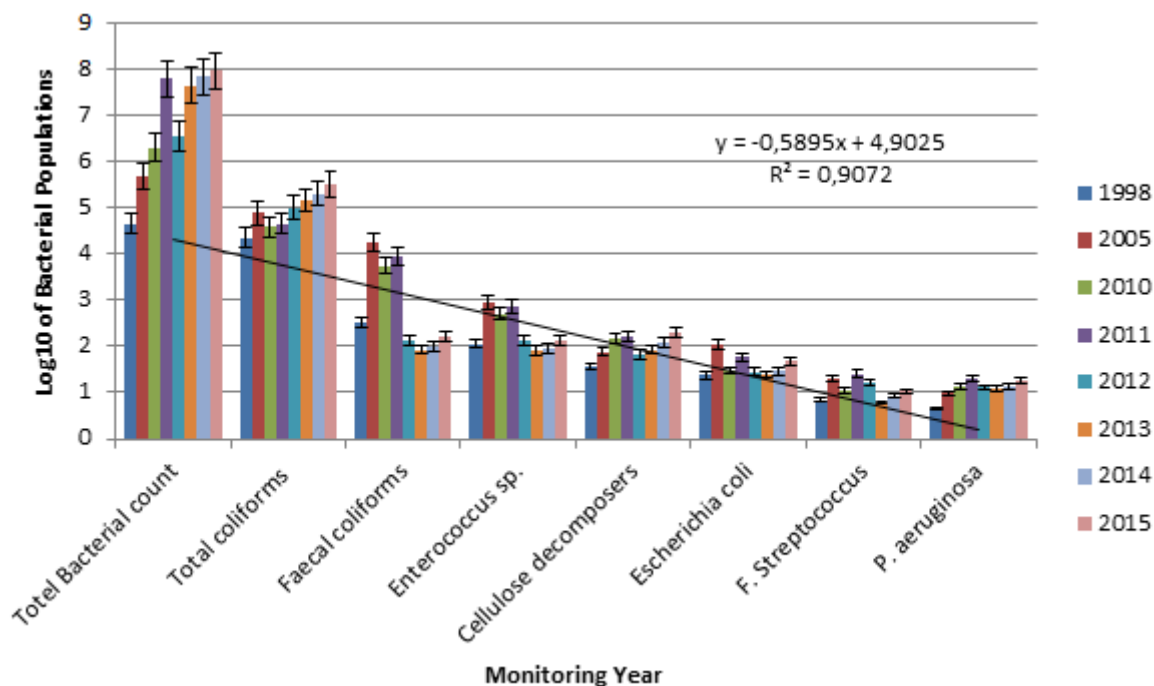

Figure 7. Monitoring the average  $\log_{10}$  of some bacterial communities in Danube River at Budapest city

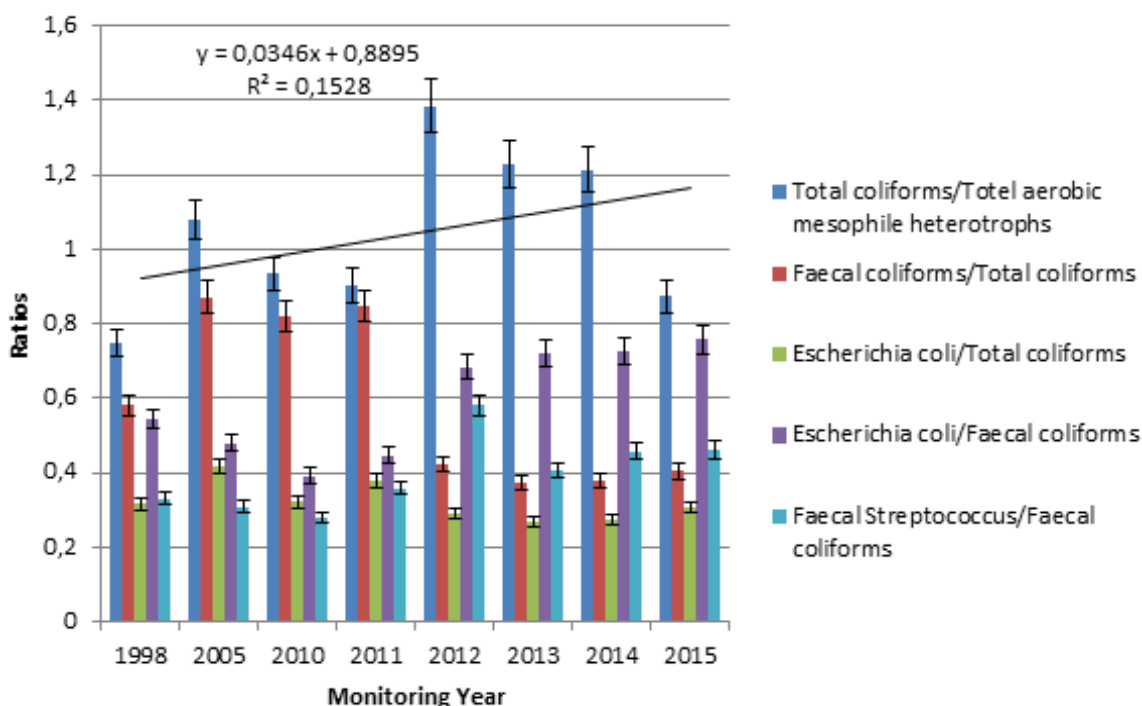

Figure 8. Monitoring the average ratios between some bacterial communities in Danube River at Budapest city

It was found that the lowest ratio was detected in 2013 (0.267) and the highest ratio was found in the monitoring year 2005. The ratio between E. coli and faecal coliform was varied between 0.392 (2010) and 0.758 (2015). The results indicated that the bacteriological assessments and bacterial populations were low in 1998 in comparison with the results of the other monitoring years. In 2012, investigations illustrated the highest faecal *Streptococcus* pollution, wherein 2010 was the lowest.

Bacterial pollution of water continues to be a widespread problem across the World and is a major cause of illness and deaths by water-borne diseases. The slight alkaline pH values and turbidity levels in the Danube water varied in accordance with the increased primary productivity and degradation of the organic pollution. Over the past few years, the application of different methods to monitor faecal pollution in diverse water sources has become very important; however, there is no universal approach which fits all requirements to allow completely reliable faecal source identification (Stricker et al., 2008). Bacteria are ideal sensors for the indication of microbial pollution of surface water because of their fast response to changing environmental status. Faecal coliforms *E. coli* and intestinal enterococci (faecal streptococci) are good indicators for the assessment of faecal pollution mainly caused by raw and treated sewage and diffuse impacts from farmland and pastures. The concentrations of heterotrophic bacteria correlate commonly to organic pollution.

In the Danube river basin total coliforms, faecal coliforms and *E. coli* indicate persistent contamination, with lower values of total coliforms in July and the highest value in August. Variations in these parameters could be spatiotemporarily linked to the number of visitors in this ecosystem (Ajeegah et al., 2012). Our investigation can support the conclusion of Ajeegah et al. (2012) as it presented in Figure 3.

Bacterial numbers positively correlated with enterococci and total coliforms. A high ratio of *E. coli* to faecal streptococci suggests a human source and a ratio less than one suggests an animal source. A differential count of the actual streptococcal species present in water can help to find out the exact source of contamination. These variations in bacterial counts among the different service reservoirs and consumer ends may be attributed to the general management practices for maintenance of service reservoirs and the possibility of reroute water pollution. Numerous factors affect bacterial concentrations in the investigated locations of Danube River. The values for all investigated groups of bacteria in the river water showed a great variability, which can be attributed to unequal loading with wastewater during the sampling seasons. Faecal coliforms to *Enterococcus* ratio indicated a human origin of the pollution. *E. coli* and faecal coliforms are the best indicators for the assessment of recent faecal pollution, mainly caused by raw and treated sewage and diffuse impacts e. g. from farm land and pasture. *E. coli* and faecal coliforms indicate also the potential presence of pathogenic bacteria, viruses and parasites (Kavka & Poetsch 2002). Kavka et al. (2006) mentioned that the higher levels of faecal pollution were found in the middle part of the Danube, particularly downstream of major cities (Budapest and Beograd) as far as 1.100 river km and again in the Lower Danube from stream-km 500 to the Danube Delta. Bacteriological contamination from faecal pollution by anthropogenic sources is considered to be a crucial problem throughout the Danube River basin imposing a threat to all kinds of water uses (Kirschner et al., 2009). Here, our investigations suggested that the Danube surface water quality was highly contaminated in 2010 more than in 2005 due to the sewage effluents. *E. coli* and intestinal enterococci are used worldwide as indicators for the assessment of faecal pollution in the aquatic environment. Faecal coliforms to *Enterococci* ratio was used to indicate the origin of pollution. A ratio lower than 1.5 indicates pollution by water flow, while a ratio higher than 4 is typical for anthropogenic pollution (Geldreich & Kenner, 1969). Our observations are confirmed by Liang et al. (2014) and Gupta et al. (2012) who indicated the cellulase activity of the organisms, by measuring the diameter of clear zone around the colony and hydrolytic value on cellulose Congo Red agar media.

Kirschner et al. (2015) summarized the historical developments in microbiological water quality research and to reflect the most recent publicly available data on the faecal microbial pollution status of the Danube River. Moreover, the first results on faecal microbial source tracking by molecular biology methods are presented along with their applicability in river water quality monitoring, including the monitoring of riparian wells and alluvial groundwater resources. Construction of urban

waste water treatment systems and development of existing systems in Danube basin should be continued receiving priority, including planning measures related to enhancing the capacities of the territorial and local levels.

Finally, a discussion of the general state of water quality and public health is presented concerning (i) the current situation and potential limitations of the Water Framework Directive regarding the microbiological quality elements, (ii) further improvements regarding sampling and monitoring strategies, and (iii) the recently introduced concept of “integrated framework of faecal pollution monitoring and management” and expected further methodological developments in the context of the Danube watershed. Rapid progress in research and development is currently being made in the area of faecal microbial source tracking, pathogen detection, and health risk assessment and these innovations are also likely to complement basic faecal pollution monitoring programs for river systems such as the Danube in the near future.

## CONCLUSION

The effects of climate change, pollution, population increase and with large numbers of new chemicals entering the river system, continuous monitoring regime for their detection will become increasingly important with respect to ecological impacts they produce. Much effort has to be directed towards the detection of such pollutants in river. The frequency of bioindicators in the river is significantly influenced by the flow condition, temperature and turbidity of the water, habitat conditions and variations as well as the chemical status of the water environment. Results indicated that the improvement of water quality of the investigated locations of Danube River in Budapest is mainly depending on the many ecological factors and the quality and quantity of the available impurities carried out by the river from the source. The presence of *E. coli* in water is nearly always associated with recent faecal pollution. So, bacteriological monitoring should be carefully chosen with respect to designated functional uses and/or the intrinsic ecological value of the river ecosystem. Monitoring program and methods should be upgraded especially with reference to the updated EN ISO Standards for isolating indicator bacteria; sampling sites should include river banks to increase the chance of detecting focal points of pollution.

## REFERENCES

- Ajeegah, G., Cioroi, M., Praisler, M., Constantin, O., Palela, M., and Bahrim, G. (2012). Bacteriological and environmental characterisation of the water quality in the Danube River Basin in the Galati area of Romania. *Afr. J. Microbiol. Res.*, 6, 292-301.
- Asamoah, D. N., and Amorin, R. (2011). Assessment of the quality of bottled/sachet water in the Tarkwa-Nsuaem municipality (TM) of Ghana. *Res. J. Appl. Sci. Eng. Technol.*, 3 (5), 377-385.
- Chen, K. Y., and Kueh, W. S. (1976). Distribution of heterotrophic bacteria related to some environmental factors in Tolo harbour. *Int. J. Ecol. Environ. Sci.*, 1, 47-58.
- American Public Health Association (APHA) (1998). *Standard Methods for the Examination of Water and Wastewater*. American Public Health Association, Washington, DC.
- APHA (2005). *Compendium of Methods for the Microbiological Examination of Food and Water*, 19<sup>th</sup> Edition. Washington, DC.
- Bayoumi Hamuda, H. E. A. F., and Patkó, I. (2012). Ecological monitoring of Danube water quality in Budapest region, *American Journal of Environmental Science*, 8, 202-211.
- Boulton, A. J. (2012). Temperature Impacts on Stream Ecology, *Water Encyclopedia* <http://www.waterencyclopedia.com/Re-St/Stream-Ecology-Temperature-Impacts-on.html>
- Comero, S., Vaccaro, S., Locoro, G., Capitani, L.D., and Gawlik, B. M. (2014). Characterization of the Danube River sediments using the PMF multivariate approach. *Chemosphere*, 95, 329-335.
- Farnleitner, A. H., Ryzinska-Paier, G., Reischer, G. H., Burtcher, M. M., Knetsch, S., Kirschner, A. K., Dirnböck, T., Kuschnig, G., Mach, R. L., and Sommer, R. (2010). *Escherichia coli* and enterococci are

- sensitive and reliable indicators for human, livestock and wildlife faecal pollution in alpine mountainous water resources. *J. Appl. Microbiol.*, 109(5), 1599-1608.
- Ford J., and Cordwell B. (1996). A framework for assessing the vulnerability of communities in the Canadian Arctic to risks associated with climate change. *Arctic*, 57, 389-400.
- Gasparotti, C. (2014). The main factors of water pollution in Danube River basin. *EuroEconomica*, 33 (1), 75-88.
- Gauthier F., Archibald, F. (2001). The ecology of "fecal indicator" bacteria commonly found in pulp and paper mill water systems. *Water Res.*, 35 (9), 2207-2218.
- Geldreich, E. E., and Kenner, A. B. (1969). Concepts of faecal streptococci in stream pollution. *J. Water Pollut. Control Fed.*, 41, R336-R352.
- Gupta P., Samant K., and Sahu A. (2012). Isolation of cellulose-degrading bacteria and determination of their cellulolytic potential. *Intern. J. Microbiol.*, Article ID 578925, 5 pages. doi:10.1155/2012/578925.
- Hendricks, C. W., Doyle, D. J., and Hugley, B. (1995). A new solid medium for enumerating cellulose utilizing bacteria in soil. *Applied Environ. Microbiol.*, 61, 2016-2019.
- International Commission for the Protection of the Danube River ICPDR (2014): Floods in June 2013 in the Danube River Basin. Brief overview of key events and lessons learned. pp.: 32.
- Kavka G. G., and Poetsch E. (2002). Microbiology. In: Literathy, P., Koller-Kreimel, V., Liska, I. (Eds.), Joint Danube Survey 1, Technical Report. ICPDR, Vienna, Austria, pp. 86-95.
- Kavka, G. G., Kasimir, D. G., and Farnleitner, H. A. (2006). Microbiological water quality of the River Danube (km 2581 - km 15): Longitudinal variation of pollution as determined by standard parameters. In: Proceedings 36th International Conference of IAD. Austrian Committee Danube Research/IAD, Vienna, pp. 415-421.
- Kirschner A. K. T., Kavka G. G., Velimirov B., Reischer G. H., Mach R. L., and Farnleitner A. H. (2008). Microbiological water quality and DNA based quantitative microbial source tracking. In: I. Liska, F. Wagner, J. Slobodnik, (Eds.), Joint Danube Survey 2, Final Scientific Report. ICPDR, Vienna, Austria, pp. 86-95.
- Kirschner, K. T. A., Kavka, G. G., Velimirov, B., Mach, L. R., Sommer, R., and Farnleitner, H. A. (2009). Microbiological water quality along the Danube River: Integrating data from two whole-river surveys and a transnational monitoring network. *Water Res.*, 43 (15), 3673-3684.
- Kirschner, T. K. A., Kavka G.G., Reischer, H. G. Sommer, R., Blaschke, A. P., Stevenson, M., Vierheilig, J., Mach, L. R., and Farnleitner, H. A. (2015). Microbiological Water Quality of the Danube River: Status Quo and Future Perspectives. *The Handbook of Environmental Chemistry*, DOI 10.1007/698\_2014\_307, Series ISSN 1867-979X. Publisher: Springer Berlin Heidelberg.
- Kittinger, C., Baumert, R., Folli, B., Lipp, M., Liebmann, A., Kirschner, A.r, Farnleitner, H. A., Grisold, J. A., and Zarfel, E. G. (2015). Preliminary toxicological evaluation of the River Danube using in vitro bioassays. *Water*, 7, 1959-1968.
- Mulk, S., Azizullah A., Korai, A. L., and Khattak, M. N. (2015). Impact of marble industry effluents on water and sediment quality of Barandu River in Buner District, Pakistan, *Environmental Monitoring and Assessment*, 187 (2):8, 1-23.
- Poonkothai, M., and Parvatham, R. (2005). Bio-physico and chemical assessment of automobile wastewater, *J. Ind. Pollution Control*, 21 (2), 377-380.
- Prescott, L. M., Harley, J. P., and Klein, D. A. (1999). The influence of environmental factors on growth. *Microbiology*. 4th Edition. McGraw-Hill Companies, Inc., USA, pp. 123-132.
- Reischer, G.H., Kasper, D.C., Steinborn, R., Farnleitner, A.H., and Mach, R.L. (2007). A quantitative real-time PCR assay for the highly sensitive and specific detection of human faecal influence in spring water from a large alpine catchment area. *Lett. Appl. Microbiol.* 44 (4), 351-356.
- Silva, T. F. B. X., Ramos D. T., Dziedzic M., Oliveira C. M. R. O., and Vasconcelos E. C. (2010). Microbiological quality and antibiotic resistance analysis of a Brazilian water supply source. *Water Air Soil Pollut., Netherlands*, 1 (1).
- Tu, J. (2013). Spatial Variations in the Relationships between Land Use and Water Quality across an Urbanization Gradient in the Watersheds of Northern Georgia, USA. *Environ. Management*, 51, 1-17.
- World Health Organisation: WHO (1996). International Standard for Drinking Water Quality. Geneva. Switzerland
- WHO (2003). Guidelines for Drinking Water Quality 3rd Edn. WHO, Geneva.
- Winter, C., Hein, T., Kavka, G. G., Mach L. R., and Farnleitner H. A. (2007): Longitudinal Changes in the Bacterial Community Composition of the Danube River: a Whole-River Approach. *App. Environ. Microbiol.*, 73 (2), 421-431.



V International Conference  
„ECOLOGY OF URBAN AREAS“ 2016

**SLUDGE REDUCTION AND GENERAL PERFORMANCE IN A  
COMBINED US+OSA SYSTEM**

**Pablo Maria Romero Pareja\*, Carlos Alberto Aragón Cruz, José María Quiroga  
Alonso, Maria Dolores Coello Oviedo**

Department of Environmental Technology, Universidad de Cádiz, Cadiz, Spain  
Foundation Centre for New Water Technologies (CENTA). Seville, Spain  
pablo.romero@uca.es, caragon@centa.es, josemaria.quiroga@uca.es, dolores.coello@uca.es

**ABSTRACT**

*The reduction of sewage sludge generated in wastewater treatment plants is one topic of interest due to the high cost related to the management of this waste and the rising amount of volume at which sludge is produced worldwide. Within the techniques to reduce sludge, the Oxic-Settling-Anaerobic (OSA) process is one of the most promising due to its simplicity and to the absence of negative consequences for system. In the OSA process the recycled sludge is submitted to an anaerobic stage prior to flow again into the biological reactor. In this study, OSA process is run in a lab scale pilot plant together with a lysis step by ultrasound treatment, applied daily to a certain fraction of the total sludge of the system previously to the anaerobic holding tank. Results point to an enhancement of sludge reduction rate for the two sonication applied regimes (45.72% and 78.56%). Also the TN removal rate increases from 21.95% during control stage to 47.28% during the first of the two ultrasound regimes applied (US1). A too intense sonication treatment during the second synergic stage (US2) is reported to lead to a serious damage of system. Increases of dehydrogenase activity were described during both stages*

**Key words:** *excess sludge reduction, OSA process, activated sludge process, ultrasound.*

**INTRODUCTION**

The number of municipal wastewater treatment plants (WWTP) is increasing remarkably worldwide, leading to a rising amount of produced sludge, a by-product of sewage treatment. In general, the activated sludge process (ASP), shows an average excess sludge production of 0.4-0.6 gVSS/gCODremoved (Paul and Liu, 2012). The management of this waste has a related cost of up to 65% of the total operating costs of a WWTP (Ferrentino et al., 2016) The reduction of excess sludge in the water line of wastewater treatment process is preferable to that in the sludge line (e.g.: digestion) as the latter intends to reduce was at origin. One of the most effective techniques for sludge reduction is the Oxic-Settling Anaerobic (OSA) process that is based on the insertion of an anaerobic tank in the recycled sludge line (Paul and Liu, 2012). This technique has shown sludge reduction rates from 20% to 60% (Ferrentino et al., 2016). Ultrasonication is a technique based on cell lysis-cryptic growth technique (Romero et al., 2013) The present study shows result of a treatment combining ultrasonication and OSA process at lab-scale highlighting the results in terms of sludge reduction, but also exposing results of fate of TN removal rate and microbial activity in sludge of system.

**MATERIALS AND METHODS**

The pilot plant was made with methacrylate with volumes of 12, 4 and 10 l for aerobic reactor, settling unit and anaerobic tank (OSA), respectively. The dissolved oxygen in aerobic reactor was set at 3 mg O<sub>2</sub>/l. Three periods were distinguishable during study of 40, 40 and 30 days of duration, respectively. During the first stage the pilot plant was run as a conventional ASP. The hydraulic residence time (HRT) was 9 h. Later, OSA anaerobic tank was introduced in recirculation line for the following periods. Next phases are referenced as US1 and US2, during which, in addition to the OSA process, ultrasonication technique (Sonics Vibracell VCX 750 device) was applied daily to a specific fraction of recycled sludge. Parameters of ultrasonication treatment are collected in Table 1. The sludge

anaerobic exposure time (SAET) and the HRT were kept at 6 and 9 h, respectively. Layout of pilot plant during US stages is shown in Figure 1.

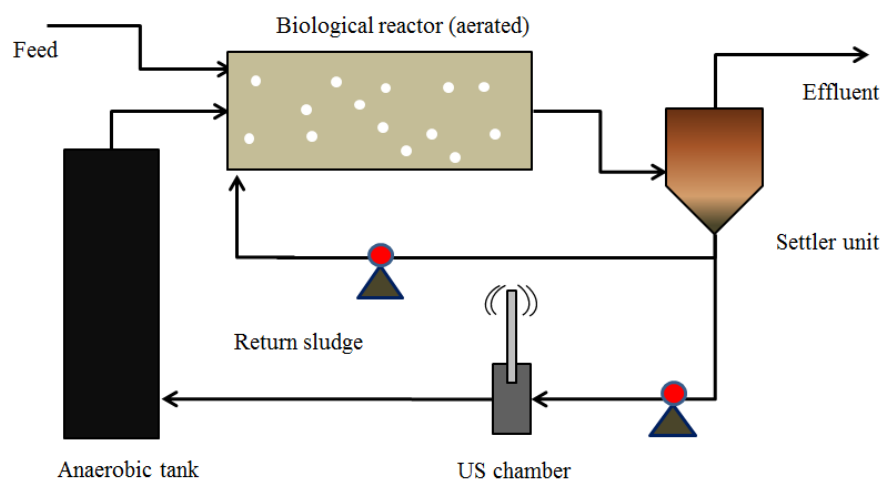

Figure 1. Layout of US+OSA plant

Table 1. Characteristics of US treatment in US1 and US2 stages

		US1	US2
Frequency US	kHz	20	20
Power density	W/ml	0.375	0.375
Frequency treatment	d-1	3	4
Energy applied (each treatment)	kJ	90	120
Specific ultrasonic energy, ES (avg.)	MJ/kg TS	35.9	62.0
Sludge sonication ratio, SP (avg.)	%	7.8	11.5
Duration of stage	d	40	30

Sludge sonication ratio, SP, is the ratio between amount of sludge ultrasonicated daily and total mass of sludge in system. The influent was characterized every two weeks and average values and standard deviation obtained were  $307.49 \pm 21.01$  mg O<sub>2</sub>/l and,  $48.62 \pm 6.13$  mg N/l in terms of COD and TN.

All measurements were carried out according to Standard Methods (2005). Dehydrogenase activity (DHA) was determined using Romero et al. (2016). Total nitrogen (TN) was measured on a Shimadzu TOC-LCPH with TN measurements.

## RESULT AND DISCUSSION

### Excess sludge production

The accumulation of sludge production during the three stages of study is shown in the Figure 2.

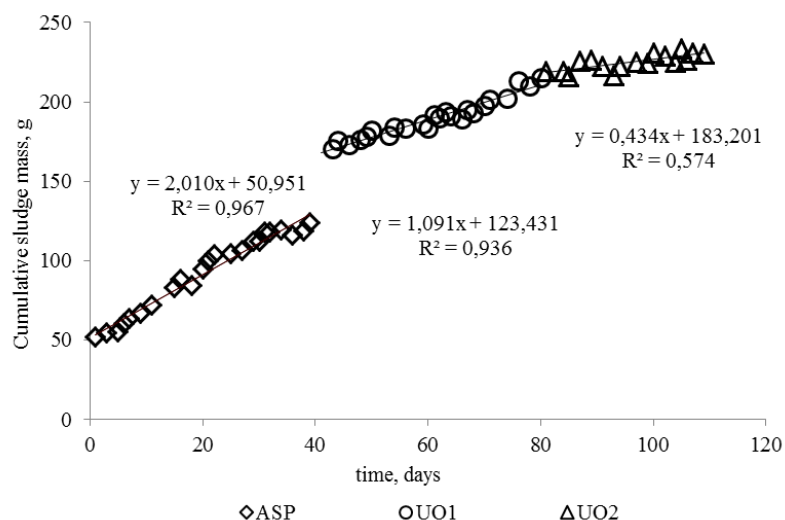

Figure 2. Cumulative sludge produced during the study

The average daily sludge production were 2.010 g/d, 1.091 g/l and 0.434 g/l for conventional phase (ASP), US1 and US2 stages, respectively, meaning a sludge reduction rate of 45.72% and 78.56% in the US+OSA phases. The reduction rate at US1 stage is higher than rates obtained for similar OSA processes (without ultrasonication): 11.5-33% (Ye et al., 2008), 18.3% (Coma et al., 2013), 19.85 (Romero, 2015) and 32% (Zhou et al., 2015).

The improvement of reduction of sludge process might be adduced to exposed phenomena: enhancement of endogenous functions of sludge with ultrasonication treatment (Xie and Liu, 2010), increment of available lysed substrate and subsequent cryptic growth and increase of biodegradability of COD (Zengin, 2016)] At the same time, the sludge reduction rate registered at US2, 78.56%, is direct consequence of decrease of solid concentration in aerobic reactor, undesirable fact leading to an deficient performance of plant.

### COD removal

The COD removal rates are collected in the Table 2

Table 2.-Average value of COD removal during the study

ASP	US1	US2
89.64±5.19	93.21±3.47	84.61±5.49

The COD removal was good throughout the study. Though the system during stage US2 was damaged cause to a too intense ultrasonication treatment, the average COD removal rate was over 75%, but lower than COD removal rates of previous stages, due to the cell decay. The light improvement of COD removal at US1 stage, leads to the finding that ultrasound did not damage COD removal capacity of biological system when treatment is not too intense as in US1 phase (Paul and Liu, 2012; Meng et al., 2014). Previous study has reported an enhancement of biological activity with ultrasonication, leading to a higher COD removal rate (Wang et al., 2006). The fact that anaerobic tank of OSA process was placed after ultrasonication step is also cause of the good assimilation of the released COD during lysis technique. This consumption of substrate in the holding tank is one of the reported mechanisms for sludge reduction in OSA process as anaerobic metabolic processes are linked to lower growth yield and gaseous products (An and Chen, 2008) entails.

### Dehydrogenase activity

The measured values of dehydrogenase (DHA) activity for the three stages of study are depicted in the Figure 3.

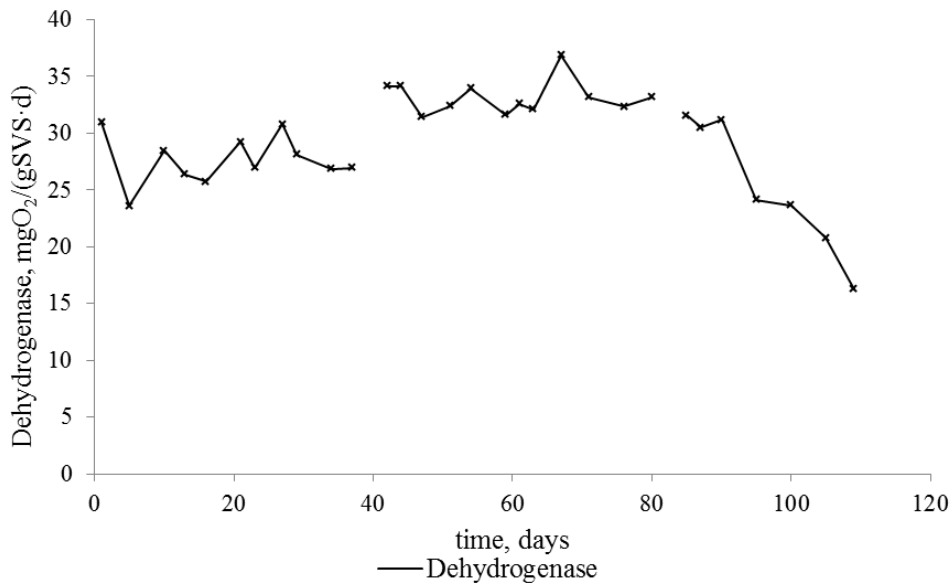

Figure 3. Dehydrogenase activities during study

The ASP stage was reported to have an average value of DHA activity of  $27.63 \text{ mgO}_2/(\text{gVSS}\cdot\text{d})\pm 2.17$ . During the first combined stage, US1, DHA activity was enhanced to an average value of  $33.16 \text{ mgO}_2/(\text{gVSS}\cdot\text{d})\pm 1.49$ , which supposes a 20.01% increase. This fact has been reported previously (Romero et al., 2016; Yang et al., 2015). Increase of DHA activity is achievable to the enhancement of endogenous metabolism, as required energy for labors of cell maintenance and reparation increases with ultrasonication treatment (Yang et al., 2015), which is, at the same time, one reason for the increase of the sludge reduction rate observed in the synergic system. When ultrasonication treatment was configured to operate at US2 phase, DHA activity decreased acutely from day 85. The ultrasonication treatment was too intense during this stage damaging the balance of cell restoration, leading also to the decrease of solids concentration mentioned previously. Specifically, the average value of DHA activity at US2 was  $25.44 \text{ mgO}_2/(\text{gVSS}\cdot\text{d})\pm 5.87$ , with clear decreasing trend.

### Total Nitrogen (TN) removal

The measured values of TN removal rate during the three stages of study are represented in Figure 4.

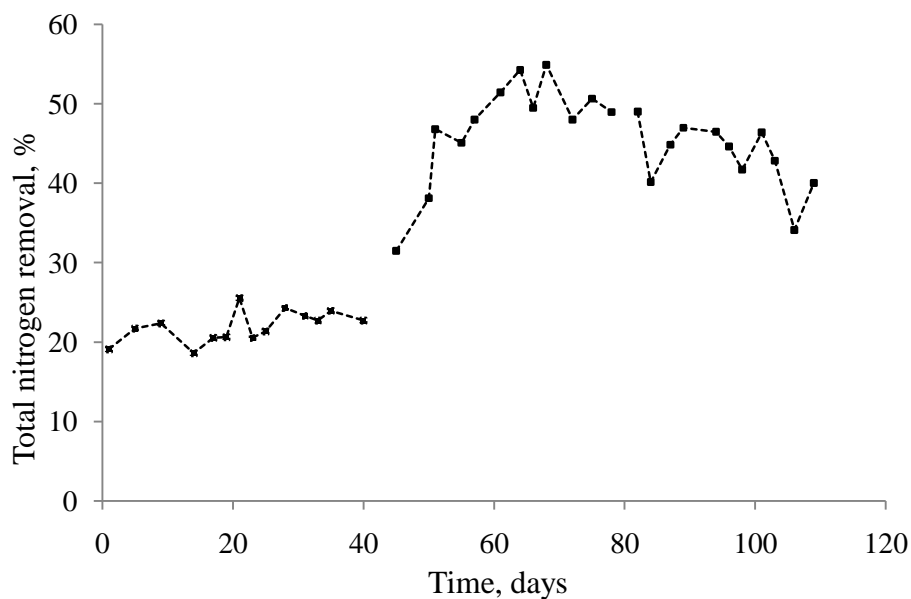

Figure 4. Total Nitrogen removal during study

Total nitrogen removal rate during ASP phase was  $21.95\% \pm 1.98$ . When the pilot plant was operating with combining system, this rate increased to  $47.28\% \pm 6.64$  during US1 stage. OSA process has been reported to improve TN removal (Paul and Liu, 2012; Foladori et al., 2015), but previous research carried out with the same pilot plant operating only OSA process (Romero, 2015), had lower TN removal rate (38.02%) that in combining system of the present study. Same finding was described in Meng et al (2014). One reason for the enhancement of TN removal process is that application of ultrasonication supplies an extra carbonaceous source with high denitrification rate (Zengin, 2016). Increasing the intensity of ultrasonication at US2 resulted in a decrease of TN removal rate, being at any case over 30% but with marked decreasing trend. The average value for TN removal at US2 stage was  $42.86\% \pm 6.01$

## CONCLUSIONS

An increase of sludge reduction rate was observed in the combining system in comparison with application of OSA process.

Performance of plant during first stage of combining system (US1) was improved, but resulted damaged for stronger US treatment (US1).

## REFERENCES

- American Public Health Association (APHA), American Water Works Association (AWWA) & Water Environment Federation (WEF) (Editors) (2005) *Standard Methods for the Examination of Water and Wastewater. 21 st Edition*. Washington DC.
- An, K.J. & Chen, G.H. (2008). Chemical oxygen demand and the mechanism of excess sludge reduction in an oxidic-settling-anaerobic activated sludge process. *Journal of Environmental Engineering*, 134(6), 469-477.
- Coma, M., Rovira, S., Canals, J. & Colprim, J. (2013). Minimization of sludge production by a side-stream reactor under anoxic conditions in a pilot plant. *Bioresource Technology*, 129(0), 229-235.
- Ferrentino, R., Langone, M., Merzari, F., Tramonte, L. & Andreottola, G. (2016). A review of anaerobic side-stream reactor for excess sludge reduction: Configurations, mechanisms, and efficiency. *Critical Reviews in Environmental Science and Technology*, 46(4), 382-405.
- Foladori, P., Velho, V.F., Costa, R.H.R., Bruni, L., Quaranta, A. & Andreottola, G. (2015). Concerning the role of cell lysis-cryptic growth in anaerobic side-stream reactors: The single-cell analysis of viable, dead and lysed bacteria. *Water Resource*, 74, 132-142.

- Meng, Z.H., Guo, W.Q., Yang, S.S. & Yu, S.L. (2014). Sludge Reduction in Anaerobic-Anoxic-Oxic System by Lysis-Cryptic Growth Using Ultrasound Pretreatment. *Advanced Material Research*, 955-959, 2687-2691.
- Paul, E. & Liu, Y.(2012) *Biological Sludge Minimization and Biomaterials/bioenergy Recovery Technologies. 1st ed.* Hoboken, N.J.: Wiley.
- Romero, P., Coello, M.D., Quiroga, J.M. & Aragón, C.A. (2012) Overview of sewage sludge minimisation: techniques based on cell lysis-cryptic growth. *Desalination and Water Treatment*, 51(31-33), 5918-5933.
- Romero, P. (2015) Progress in the application of techniques to sewage sludge reduction: OSA process and ozonation. PhD Thesis, University of Cadiz.
- Romero, P.M.R., Jiménez, A.R., Aragón, C.A., Quiroga, J.M. & Coello, M.D. (2016). Changes in enzymatic and microbiological activity during adaptation of a conventional activated sludge (CAS) to a CAS-oxic-settling-anaerobic (OSA) adapted process. *Desalination and Water Treatment*, 57(6), 2719-2725.
- Wang, F., Lu, S. & Ji, M. (2006). Components of released liquid from ultrasonic waste activated sludge disintegration. *Ultrasonics Sonochemistry*, 13(4), 334-338.
- Xie, B. & Liu, H. (2010). Enhancement of biological nitrogen removal from wastewater by low-intensity ultrasound. *Water air and soil pollution*, 211(1-4), 157-163.
- Yang, S.S., Guo, W.Q., Chen, Y.D., Wu, Q.L., Luo, H.C., Peng, S.M., Zheng, H.S., Feng, X.C., Zhou, X. & Ren, N.Q. (2015). Economical evaluation of sludge reduction and characterization of effluent organic matter in an alternating aeration activated sludge system combining ozone/ultrasound pretreatment. *Bioresource Technology*, 177, 194-203.
- Ye, F.X., Zhu, R.F. & Li, Y.(2008). Effect of sludge retention time in sludge holding tank on excess sludge production in the oxic-settling-anoxic (OSA) activated sludge process. *Journal of Chemical Technology and Biotechnology*, 83(1), 109-114.
- Zengin, G.E.(2016). Respirometric evaluation of biodegradation kinetics for ultrasonic disintegrated domestic sludge. *Desalination and Water Treatment*, 57(2), 582-590.
- Zhou, Z., Qiao, W., Xing, C., Wang, C., Jiang, L.M., Gu, Y. & Wang, L. (2015). Characterization of dissolved organic matter in the anoxic-oxic-settling-anaerobic sludge reduction process. *Chemical Engineering Journal*, 259, 357-363.

V International Conference  
„ECOLOGY OF URBAN AREAS“2016

## CO-SUBSTRATES INFLUENCE ON METHANE GENERATION THROUGH WASTE WATER ANAEROBIC DIGESTION

Adriana Raluca Wächter<sup>1</sup>, Reinhold Wächter<sup>1</sup>, Ioana Ionel<sup>1\*</sup>

<sup>1</sup> Politehnica University of Timisoara, Faculty for Mechanical Engineering,  
Mihai Viteazu Blvd., No.1, 300222, Timisoara, Romania  
avram\_adriana21@yahoo.com, wachter\_reinhold@yahoo.com, \*ioana.ionel@upt.ro

### ABSTRACT

*In many countries, sustainable waste management and prevention of accumulation and reduction of waste have become major political priorities, and represent an important contribution to common efforts to reduce pollution and emissions of greenhouse gases and mitigate global climate change. By applying the Waste to Energy (WtE) concept, organic waste can be used as a rich source of energy recovery and turn it into electricity and/or heat. The high content of organic constituents found in this type of waste renders it to be suitable for regenerative bio-energy process, where the energy recovery potential is developed through an anaerobic digestion process. Thus, the presented study focuses on the biogas production through anaerobic process, applied on a waste water treatment plant, which is using co-substrates provided from food industries in order to increase the methane generation. The methodology approached is to highlight the influence of the added co-substrates on the digestion process, and the possibility of the energy recovery in suitable units to mitigate the highest value of energy efficiency. The case study of Straubing Waste Water Treatment Plant (WWTP) – Germany - is related. Findings related to the present papers are reflected in the bio methane quantities produced by a state of the art anaerobic digestion facility.*

**Key words:** waste water, energy recovery, biogas, anaerobic digestion.

### AIMS AND BACKGROUND

Growing population and expanding industry in urban areas, which are increasingly well served by waste water treatment plants (WWTP), result in rapid regional growth of sewage sludge production/quantities. New European regulations on wastewater sludge management will have an impact on virtually every bio-solids disposal method, including application to agricultural land. The new regulations have restricted land use of sludge based on pathogen destruction criteria.

Anaerobic treatment is presently employed at most WWTP, and is responsible for the major fraction of waste stabilization that occurs there (Han et al., 197; Cakir et al., 2007). Because of the emphasis on energy conservation and recovery and the desirability of obtaining beneficial use of wastewater sludge, anaerobic digestion has been and will continue to be the dominant sludge stabilization process (Bachmann et al., 2015). Anaerobic digestion (AD) is a proven technology for sewage sludge treatment and which allows generation of renewable energy from the same process.

During AD, microorganisms break down the organic matter contained in the sludge and convert it into biogas, a mixture of mainly methane and carbon dioxide, which is *an eco-friendly renewable energy source*. At the same time, the sludge is stabilized and its dry matter content is reduced. Anaerobic digestion is a technologically simple process, with a low energy requirement, used to convert organic material from a wide range of wastewater types, food industries wastes and biomass into methane (de Mes et al., 2003).

The benefits of AD of sewage sludge are widely recognized and the technology is well established in many countries. Today, a high proportion of biogas produced in AD plants is from those on WWTP

sites. As important consumers and generators of energy, WWTPs are one of the numerous players influencing developments towards energy sustainability (Bachmann et al., 2015; de Mes et al., 2003).

In addition to sewage sludge, some WWTPs include other organic feedstock in the anaerobic reactor. This is referred to as co-digestion. Co-digestion is the simultaneous digestion of a homogenous mixture of two or more substrates. Traditionally the AD was applied for one type of organic materia, as single purpose treatment. Recently, it has been notice that AD became more stable when a variety of substrates with high organic content are applied (Caramonaa et al., 2013; Sebola et al., 2015). This can lead to a significant increase of the gas production because most co-substrates have a considerably higher methane production (per ton) of fresh matter than sewage sludge (Figure 1) (Korazbekova et al., 2015; Nielfa et al., 2015; Bachmann et al., 2015).

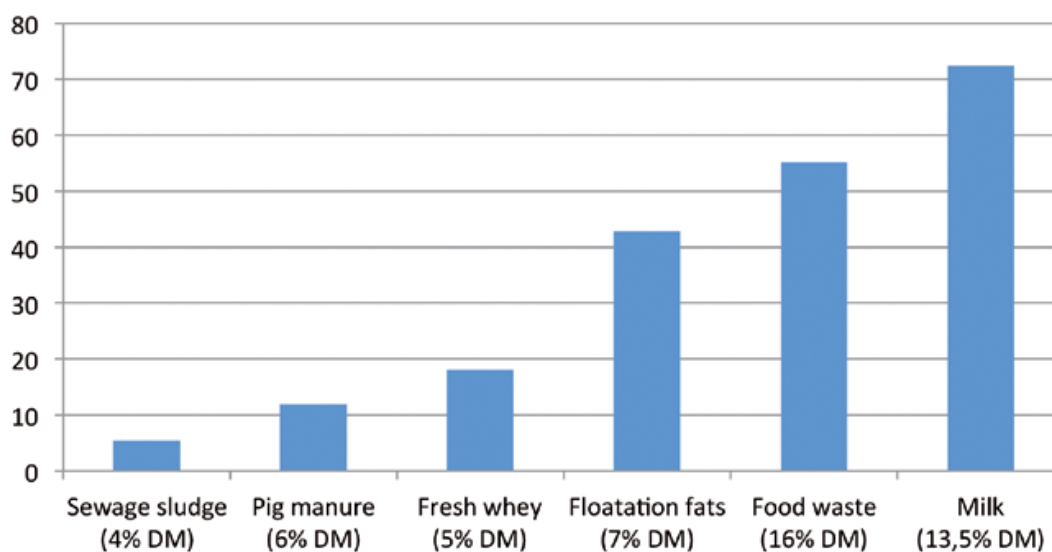

Figure 1. Examples of methane potential of different substrates (Bachmann et al., 2015)

This is due to lower water content and high contents of energy-rich substances such as proteins, carbohydrates and fats in co-substrates. Basically, the organic material attested in dry matter (DM) of the co-substrates represents the “food” to specific AD methanogen bacteria. As co-digestion in WWTP is subject to strict regulations in most countries, the legal situation has to be studied carefully before planning to proceed in the direction of co-digestion. Co-digestion is an interesting option to optimize the biogas production, but it also involves additional work and infrastructures at the WWTP (Bachmann et al., 2015; Strand et al., 2010; Korazbekova et al., 2015).

Thus, the presented study focuses on the biogas production through anaerobic process, applied on a waste water treatment plant, which is using co-substrates provided from food industries, in order to increase the bio-methane generation.

The methodology approached is to highlight the influence of the added co-substrates on the digestion process, and the possibility of the energy recovery in suitable units to mitigate the highest value of energy efficiency. The case study of Straubing Waste Water Treatment Plant – Germany is related. Findings related to the present papers are reflected in the bio methane quantities produced by a state of the art anaerobic digestion facility.



## CASE STUDY WWTP STRAUBING

### Overview of Straubing WWTP

The Straubing waste water treatment technological process is a novel way for sludge management that is based in a centralized approach. Smaller waste water treatment plants deliver their sludge, mostly excess activated sludge to the Straubing WWTP. Roughly 30 municipal waste water treatment plants deliver their sludge, leading to a twofold increase of the produced sludge in Straubing. The Straubing WWTP plant is designed for 200.000 population equivalents. The average load is 6.2 Million m<sup>3</sup> of waste water are processed per year that results into approx. 8.000 tons of dewatered sludge are produced per year. The sludge stabilization occurs in two AD digester of 3.000 m<sup>3</sup> each. The energy recovery occurs in two Combined Heat and Power (CHP) units, one with biogas engines with installed power of 2 x 0.5 MW, and other with mono-combustion of the resulted sludge (Pettrak et al., 2016). The process flow diagram of the Straubing WWTP is presented in Figure 2.

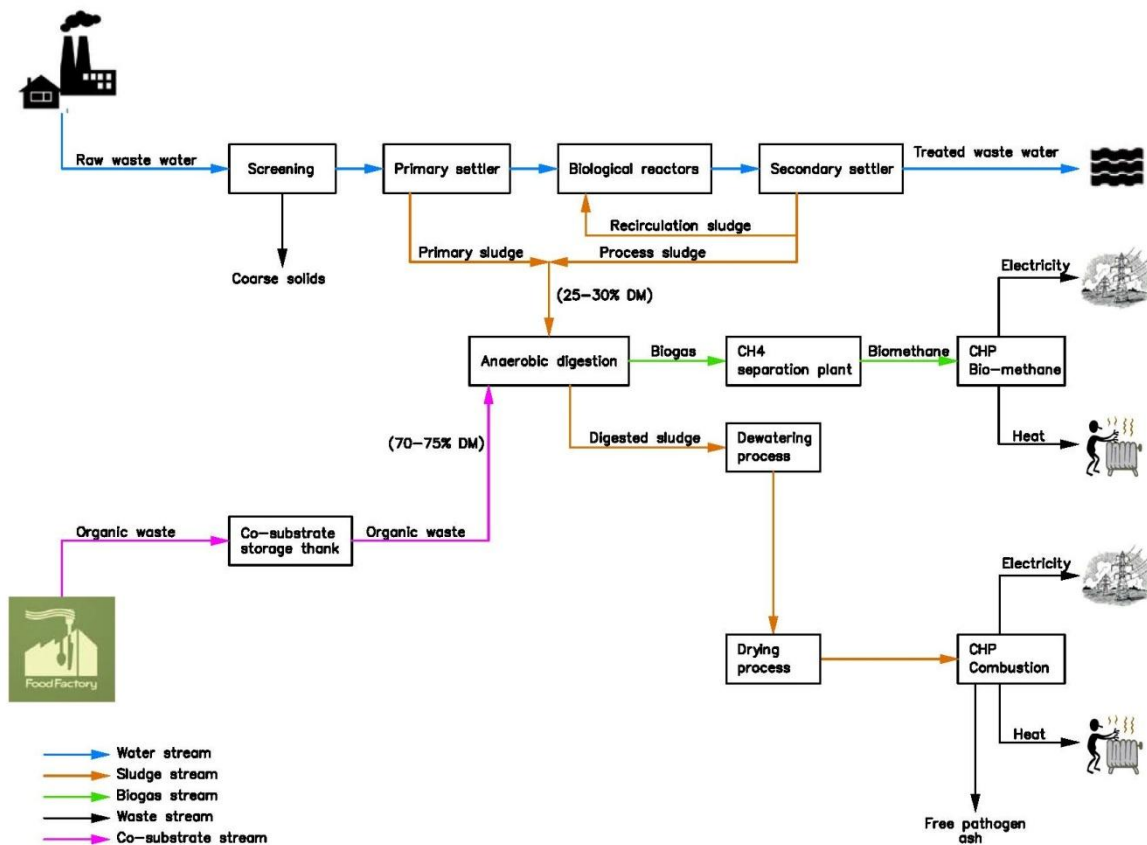

Figure 2. Straubing WWTP process flow diagram (Neamt et al., 2014)

As it can be seen from figure 2, the AD reactors are feed up with two type of organic material, one with the sewage sludge of the urban area of Straubing and the surroundings, and the other with the organic wastes provided from the food factories in the area. From the stream of WWTP treatment processes of the sewage sludge results a mixture of primary and process sludge, which is suitable for an AD process, due to the fact that its water content is significantly reduced.

The food industry organic wastes used for the subjected AD process are uneatable milk, fat floats and slaughterhouse offal. These products offer significantly higher production of biogas than sewage sludge itself and enable the waste water treatment plant to produce enough power to be net energy self-sufficient and to feed surplus energy back to the grid. Infrastructure for 24/7 delivery of food waste and controlled release to the AD digester was built and implemented in the control system (Pettrak et al., 2016). From total organic load of the digested material, 70-75% is given by the co-substrates and only 20-25% by sewage waste water (Neamt et al., 2014). The organic load of the digested sludge is given by the biodegradable organic compounds contained into co-substrates, which leads to high methane production rates. The resulted bio-methane is recovered in two 0.5 MW diesel engines in order to produce electricity and heat.

The anaerobic digested sludge is dewatered by centrifuge until 27% of medium dry matter content is reached. The effluent resulted from these process is treated to lower loads of ammonium. The dewatered sludge is pumped further to a belt dryer where the excess heat of the CHPs enables the removal of water to a dry matter content of up to 95%. Due to the low water content, the dried sludge is use into mono-combustion CHP unit, where the contained pathogens are destroyed, and heat energy is recovered. The Straubing CHP mono-combustion facility was a part of a project called sludge-to-energy (S2E), and it was use until 2014. The S2E project has proven technical, but seems to lack economic feasibility (mostly related to the high investment costs of the prototype used for the combustion of sludge). Presently, the combustion on Straubing WWTP is suspended and the basic conditions for an economic operation are evaluated (Pettrak et al., 2016) for a future strategy.

Because of the co-fermentation the dried sludge cannot be used for land fertilizer, and is transported by trucks for co-incineration on fired coal power plants and cement ovens.

### The Co-fermentation AD process at the Straubing WWTP

As described above, the AD process developed at Straubing WWTP is using co-substrates provided from food industry facilities in order to increase biogas production. The process flow diagram of biogas production on Straubing WTTP is presented in figure 3.

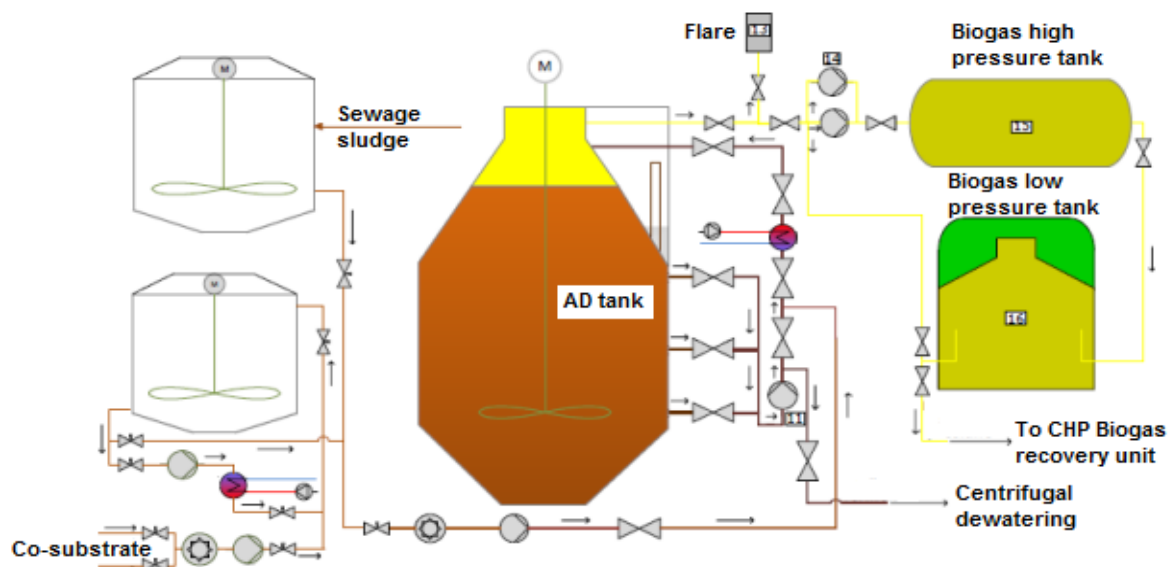

Figure 3. Anaerobic digestion process on Straubing WWTP (Neamt et al., 2014)

The main aspects of the AD process presented in figure 3 are following:

- The co-substrates are transported by the industrial food factories to Straubing WWTP by truck, and received into four storage tanks with a capacity on 40 m<sup>3</sup> each;
- On retention time on storage tanks, the co-substrates are subjected to a hydrolysis fermentation process before introduction into AD reactors;
- The co-substrate mixture is kept around 35 °C, by a heat exchanger and a recirculation pump;
- The mixture between co-substrates and sewage sludge occurs into an AD digester, where a mesophilic digestion is developed at 35 °C temperature;
- The AD reactor feeding system and the evacuation of the digested sludge is depending on several parameters of the AD process, which are controlled by a fully automatized system.

In order to raise the methane generation capacity for food waste (co-substrates), the hydrolytic steps of biogas production for these products are separated in the storage tanks, where are maintained temperature of 35 °C, which leads to an incomplete fermentation process. These products are degraded to smaller molecules and then processed in the digester. Figure 4 shows the steps necessary in biogas production (Pettrak et al., 2016).

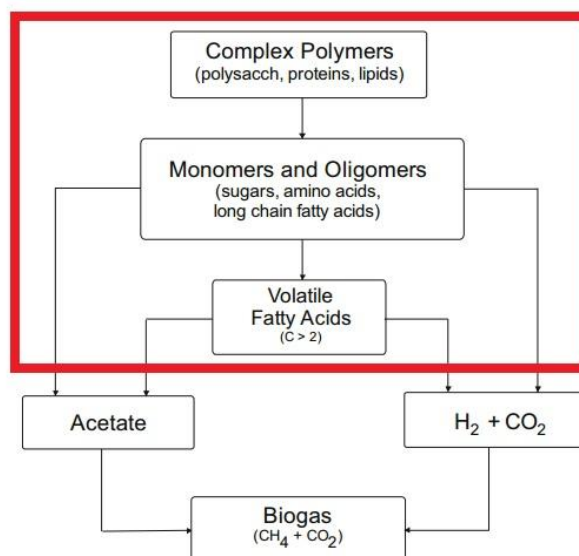

Figure 4. Hydrolysis fermenter stage on storage tanks (Pettrak et al., 2016).

The marked rectangle shows the hydrolytic steps that are separated in the hydrolysis fermenter. The hydrolysis process lowers the retention period of the co-substrates into the AD reactors and raises the yield of biogas production (Pettrak et al., 2016).

### AD energy production rates

In order to create an overview of the energy productions based on bio-methane arise from AD process it was survey a period time from 2011 to 2014 for subjected WWTP case study. The biogas production rates according to the AD mass flow streams are given in table 1 (Neamt et al., 2014).

Table 1: Biogas production arise from digested material mass flow streams

Year	Sewage sludge		Co-substrates		Digestate		Biogas production [m <sup>3</sup> ]
	mass	moisture	mass	moisture	mass	moisture	
	[to]	[%]	[to]	[%]	[to]	[%]	
2011	46964	97,22	27029	93,61	73993	95,90	2352654
2012	41687	97,20	38955	94,51	80642	95,91	2364100
2013	42920	97,68	37743	94,52	80662	96,20	2494113
2014	45109	97,68	24605	90,98	69714	95,32	2581287
Average	44170	97,4	32083	93,4	76253	95,8	2448038,5

As resulted from table 1, it can be observed that the yield biogas production is slightly different to the mass flow of digested co-substrates mass flow. One concludes that the biogas production is strongly influenced by the organic composition of the co-substrates. Based on data from table 1 a comparison mass flow between sewage sludge and co-substrates used for the AD process is shown in figure 5.

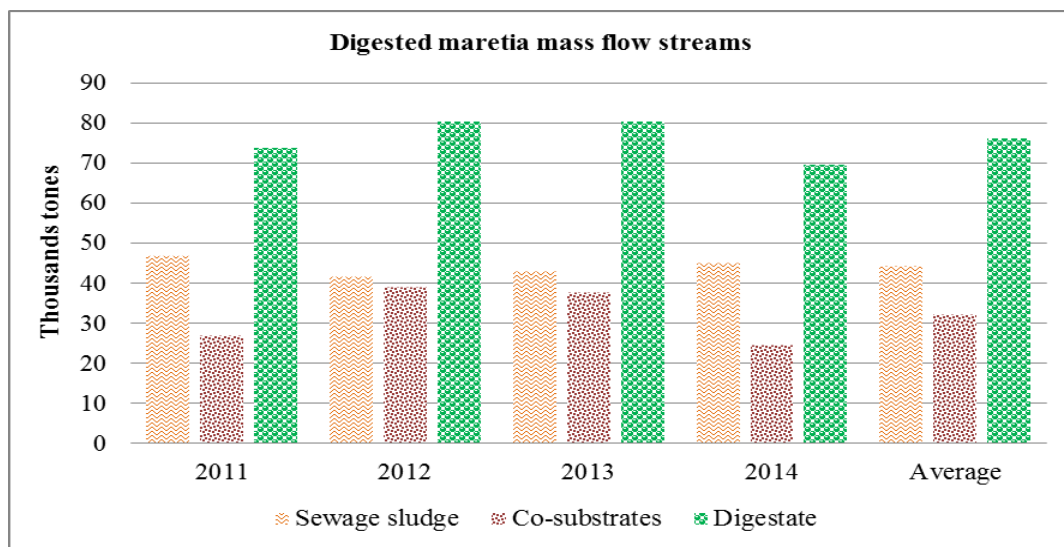

Figure 5. AD processed mass flow streams

As was mention above, the produced biogas is energy recovered into CHP biogas unit. The survey data for thermal and electrical energy recovered is presented in table 2.

Table 2: Energy recovery in CHP biogas unit of WWTP Straubing (Neamt et al., 2014)

Year	Biogas production	Biogas recover efficiency	Potential biogas energy recovery*	Theoretical energy recovery at $\eta_{max}$ **		Effective energy recovered		Energy recovery efficiency	
	m <sup>3</sup> /year	%	MWh/y	MWh <sub>t</sub>	MWh <sub>e</sub>	MWh <sub>t</sub>	MWh <sub>e</sub>	Term. %	Electric %
2011	2352654	86,40	16414	6402	6566	2981	5679	46,57	86,49
2012	2364100	86,82	16494	6433	6598	3080	5573	47,88	84,47
2013	2494113	91,59	17401	6787	6961	3140	5380	46,27	77,30
2014	2581287	94,79	18010	7024	7204	2704	5859	38,50	81,34
Average	2448039	89,90	17080	6661	6832	2976	5623	44,68	82,30
Designed	2723136	100	18999	7410	7600	-	-	-	-

\*Based on biogas lower calorific value of: 6.97 kWh/m<sup>3</sup>.  
 \*\*Biogas engine yield for thermal energy at  $\eta_{max}=39\%$  and for electrical energy at  $\eta_{max}=40\%$ .

As it is shown in table 2, it can be observed that the biogas recover efficiency is around the design parameters, which means that the AD digestion tank are used in a range of 85 to 95 % of capacity. The potential biogas energy recovery is meant to highlight the contained energy in the volume of the produced biogas, if the entire quantity of biogas is burnout at 100 % efficiency, calculated on the 6.97 kWh/m<sup>3</sup> of biogas lower calorific value. Due to the fact that the biogas is used as fuel in biogas engines, the biogas recovered energy is influenced by the biogas engine yield for thermal and electrical energy. Energy recovery efficiency was calculated based on the theoretical energy recovery versus the effective energy recovered, that underlines the amount of the extra energy available in biogas and is not recovered, as it is shown in figure 6.

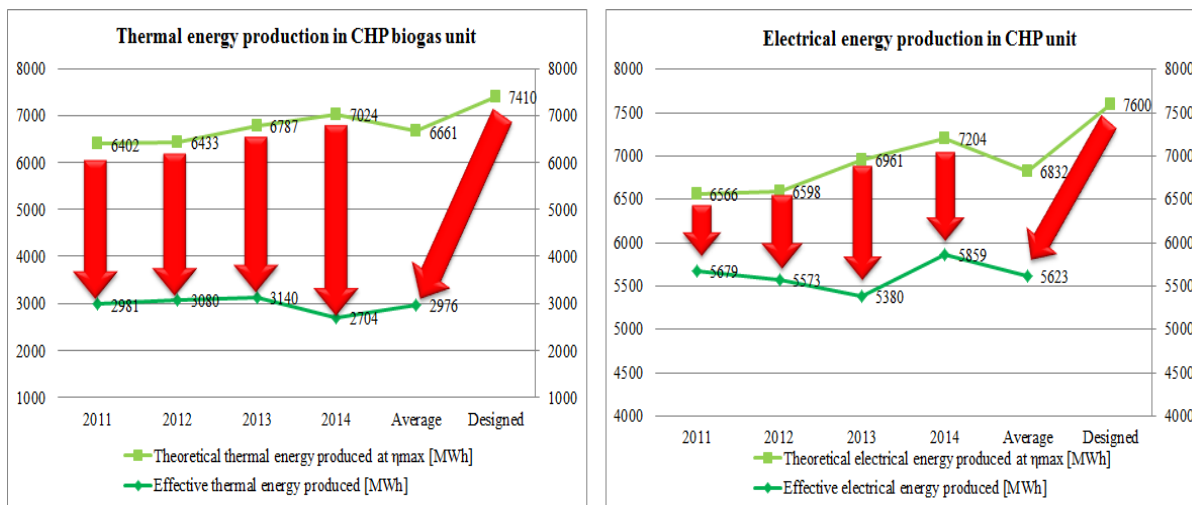

Figure 6. Comparison between theoretical and effective energy recovered in CHP biogas unit

One concludes that the AD process is generating a much higher quantity of biogas that the CHP biogas unit is able to consume, which means that the CHP biogas recovery process should be optimized. From figure 6, it can be observed that the amount of the thermal energy recovered is around 40 to 48 % of the potential, and this is explained based on the available thermal energy that is mostly used in the cold season for mesophilic AD process.

## CONCLUSIONS

Anaerobic digestion is a proven technology for sewage sludge treatment, which allows generation of renewable energy from the same process. Co-digestion is an interesting and promising option to optimize the biogas production, generating a significant increase of the gas production. As co-digestion in WWTP is subject to strict regulations in most countries, the legal situation has to be studied carefully before planning to proceed in the direction of co-digestion.

The subjected case study highlights the influence of the co-substrates in the AD biogas production rate. According to the biogas production rates on the subjected case study, in order to recover the entire energy contained in the produced biogas an additional biogas engine should be installed.

## ACKNOWLEDGEMENTS

This work was achieved from the position of PhD student of the first author at the Politehnica University of Timișoara. Also the project RESGAS - HURO/1001/193/2.2.2, developed under the support of the HUNGARY – ROMANIA CROSS BORDER COOPERATION PROGRAMME 2007 – 2013 is to be acknowledged. Also the company Straubing waste water treatment and its collaborators are acknowledged, with appreciation and warm thanks for the scientific support.

## REFERENCES

- Yue Han (1997): Laboratory studies on the temperature-phased anaerobic digestion of mixtures of primary and waste activated sludge. *PhD Thesis – Iowa State University, p.10.*
- Cakir F.Y. Stenstrom M. K (2007): Anaerobic treatment of low strength wastewater. *Proceedings of the Water Environment Federation*, (30), p. 5178-5207.
- Bachmann N., J.C. Jansen (2015): Sustainable biogas production in municipal wastewater treatment plants. *Published by IEA Bioenergy, p.4-13.*
- T.Z.D. de Mes, Stams A.J.M., Reith J.H., Zeeman G. (2003): Methane production by anaerobic digestion of wastewater and solid wastes. *Bio-methane & Bio-hydrogen: status and perspectives of biological methane and hydrogen production*, p. 58 - 102.
- Strand Associates Inc (2010): Wastewater Treatment Plant Study – City of Whitewater Wisconsin. Section 3 – Evaluation of Alternatives.
- Carmonaa P.C.R., Piechotaa T., Mazura R. (2013): Influence of Added Co Substrates, Technical and Technological Factors on the Fermentation Process of Municipal Wastewater Sludge. *6th International Conference on Information and Communication Technologies in Agriculture, Food and Environment*, Procedia Technology (8), p.618 – 621.
- Sebola M. R., Tesfagiorgis H. B., Muzenda E. (2015): Methane production from anaerobic co-digestion of cow dung, chicken manure, pig manure and sewage sludge. *Proceedings of the World Congress on Engineering 2015, Vol I WCE, London, U.K.*
- Korazbekova K., Bakhov Z., Mutaliyeva B. (2015): Influence of Co-substrates for the Methane Production Rate Kinetics in Anaerobic Fermentation of Pig Slurry. *Modern Applied Science*; Vol. 9, No. 6; p.217-225.
- Nielfa A., Cano R., Fdz-Polanco M. (2015): Theoretical methane production generated by the co-digestion of organic fraction municipal solid waste and biological sludge. *Biotechnology Reports* (5), p.14–21.
- Pettrak J., Nikolaus W. and Pop C. (2016): The “Straubing Model” Of Sludge Management - State Of The Art and Prospect. *Scientific and technical conference sludge management*, p.64-70.
- Neamț I. (2014): Theoretical and experimental research on energy recovery from waste water treatment plant sewage sludge. *PhD Thesis – Politehnica University Timișoara, p.73-75.*

V International Conference  
„ECOLOGY OF URBAN AREAS“ 2016

**GROUNDWATER QUALITY WITH RESPECT TO THE LEVELS OF  
NITRATE AND FLUORIDE IN URBAN AREA OF MALAYER CITY  
AND THE ASSOCIATED HEALTH RISK**

**Mohamad Sakizadeh<sup>1\*</sup>, Fatemeh Mehrabi Sharafabadi<sup>2</sup>, Eshagh Shayegan<sup>1</sup>**

<sup>1</sup>Assistant professor, Department of Environmental Sciences, Faculty of Sciences,  
Shahid Rajaei Teacher Training University, Tehran, Iran

<sup>2</sup> Graduate Student, Jundishapur University of Medical Sciences

**ABSTRACT**

*The main objective of this study was to consider the quality of groundwater in Malayer, Iran with an emphasis on the levels of nitrate and fluoride which pose a threat to public health. In addition, the health risk assessment of nitrate for adults and children was another aim of this study. The values of 13 water quality parameters (including Turbidity, pH, Cl residue, TDS, Total hardness, Total alkalinity, Fluoride, Bicarbonate, Nitrite, Nitrate, Ca, Mg, Na, K) were analyzed in 27 sampling wells during 2012 and 2013. The health risk assessment of nitrate in groundwater was also implemented. The value of nitrate has fluctuated between 3.95 and 50.16 mg/l in the groundwater samples whereas the amounts of fluoride varied between 0.06 and 1.21 mg/l. As a whole, 81.5 percents of nitrate samples have been higher than this standard value and 36 percents of the fluoride samples were not within the standard levels. The health risk of nitrate in children was higher than that of adults in a way two samples for the adults had a hazard quotient of over than one whereas this was four sampling stations for the children. As the level of fluoride in groundwater was less than the permissible level it may incur dental decay in groundwater consumers.*

**Key words:** *Groundwater, Nitrate, Fluoride, Hazard quotient.*

**INTRODUCTION**

In arid and semi-arid environments, groundwater is the most important source of water supply for both drinking purposes and agricultural activities so, maintaining the quality of this water resource is of paramount importance (Qin et al.2011). In addition, because of low rainfall and high evaporation in these areas the recharge of groundwater is slow resulting in sluggish remediation of groundwater in case of contamination. The over-exploitation of groundwater resources besides intensive agricultural activities put an escalating pressure on the soil and water resources especially in arid and semi-arid environments of Iran (Jalali 2007). This phenomenon has been exacerbated due to the recent droughts in the middle-east region.

Among water quality parameters, nitrate is a natural ion and part of nitrogen cycle in the environment (Nas and Berktaş 2006). Nitrate is a stable nitrogen form in well aerated systems. Despite its low chemical affinity it can be reduced by microbial activities as well. Biological and chemical activities can reduce nitrite to different forms or oxidize it to nitrate. Due to high solubility, nitrate has a high mobility in ground waters (Fytianos and Christophoridis 2003) and does not tend to bond to solid materials in the aquifer (Hem 1985).

Apart from the confirmed methemoglobinemia that is a resultant health impact of high levels of nitrate and the associated nitrite in drinking water, there are other inconclusive health outcomes related to nitrate such as cancer (via the bacterial production of N-nitroso compounds), hypertension, increased infant mortality, central nervous system birth defects, diabetes, spontaneous abortions, respiratory tract infections, and changes to the immune system (Fewtrell 2004).

On the other hand, the prevalence of dental fluorosis, which is caused by excess fluoride intake during the period of preemptive tooth formation, is also the direct consequence of high levels of fluoride in

drinking water (Heller 1997). However even though, minor values of this element can prevent dental decay so, it is added in negligible values to the drinking water in some countries.

The study area is located in Malayer City and its related rural region in which there have been some earlier studies on groundwater contamination in this field. For instance, Rafati et al.(Rafati 2013)considered the values of fluoride in groundwater of Hamedan Province in 2012 and concluded that the amounts of fluoride varied between 0.23 to 1.63(mg/l) and 10 samples were below the standard values however none of the samples exceeded the permissible levels in this field. Jalali and Kolahchi(2008) studied the values of some water qualities including nitrate in the groundwater of northern part of Malayer and concluded that Seventy-five percents of the water samples showed nitrate ( $\text{NO}_3^-$ ) concentrations above the human-affected value ( $13 \text{ mg l}^{-1}\text{NO}_3^-$ ), while more than 12.5% exceeded the maximum acceptable level ( $50 \text{ mg l}^{-1}\text{NO}_3^-$ ) according to World Health Organization (WHO) regulations.

Considering this introductory comments, the main objectives of this study were (i) to consider the quality of groundwater for drinking purposes with an emphasis on fluoride and nitrate (ii) to study the health risk of nitrate for the adults and children in the groundwater of the study area.

## METHODS

Thirteen groundwater quality variables(including Turbidity,pH,Cl residue, TDS, Total hardness,Total alkalinity Fluoride,Bicarbonate,Nitrite,Nitrate,Ca,Mg,Na,K) were taken from 27 wells in Malayer,Iran during 2012 and 2013 years. pH was determined in-site using a pH meter. Calcium and Mg were determined titrimetrically while Na and K were measured by flame photometry. On the contrary,  $\text{HCO}_3^-$  and  $\text{Cl}^-$  were determined titrimetrically. Finally fluoride and nitrate and nitrite were recorded using UV-Spectrophotometry method.The analysis of parameters was implemented in Hamedan Regional Water Authority's laboratory.

The health risk assessment of nitrate in the groundwater was considered using the USEPA's method regarding equation 1 and 2(Su et al.2013):

In equation 1,R is the non-carcinogenic hazard quotient of nitrate in the drinking water, CDI is the daily intake of nitrate per body weight(mg/l day),RfD is the reference dose(mg/l day).On the other hand, in equation 2, $C_w$  is the concentration of nitrate in groundwater(mg/l), $W_i$  is the daily intake of water(L/day),F is the frequency of exposure to water pollution(day/year),D is the total duration of exposure(year),W is the body weight(kg) and T is the average time(day).In the above-mentioned equations,  $W_i$  is 2.3 and 1.5 for the adults and children, respectively. The time of exposure to pollution due to the probability of emigration of rural people is 30 and 6 years for the adults and children. The body weight for the adults and children are 60 and 35 kg while the time for adults and children was 10950 and 2190, respectively.

$$R = \frac{CDI}{RfD} \quad (1)$$

$$CDI = \frac{C_w * W_i * F * D}{(W * T)} \quad (2)$$

## FINDINGS AND DISCUSSION

Descriptive statistics of groundwater quality parameters have been presented in Table1.With respect to this Table, the value of nitrate has fluctuated between 3.95 and 50.16 mg/l in the groundwater samples whereas the amounts of fluoride varied between 0.06 and 1.21 mg/l. As has been proposed by Eckhardt and Stackelberg(1995), if the levels of nitrate in groundwater exceed 13mg/l it is most likely originated from human activities. According to this prescribed level, 22 out of 25 sampling stations (81.5 percents) have been higher than this standard value. On the other hand, the permissible range of fluoride in groundwater samples are between 0.5 and 1.5 mg/l (Dissanayake 1991) in which below this level the risk of tooth decay increases and above it the symptoms of fluorensis are occurred,



accordingly. The mean and standard deviation of fluoride in the samples were 0.58 and 0.33mg/l, respectively. As a whole, 36 percents of the fluoride samples were less than the standard value. The correlation coefficients among water quality parameters have also been given in Table2. On the contrary, the decreasing order of cations in the groundwater based on the results of Table1 was Na>Ca>Mg>K. The results of health risk of nitrate for adults and children have been illustrated in Figure1 and Figure2, respectively.

Table1: Descriptive statistics of groundwater quality variables for sampling wells in Malayer, Iran

Groundwater quality variables	Mean	Min	Max	Standard Deviation
Turbidity	1.10	0.45	7.54	1.41
pH	7.61	6.47	8.05	0.35
TDS	308.95	7.73	525.00	115.43
Total hardness	280.67	70.00	488.00	81.17
Total alkalinity	239.30	25.00	365.00	79.16
Fluoride	0.58	0.06	1.21	0.33
Bicarbonate	244.07	25.00	365.00	66.80
Nitrite	0.24	0.00	5.16	1.00
Nitrate	23.67	3.96	50.16	12.02
Ca	81.97	24.00	250.00	43.09
Mg	26.54	4.37	136.00	24.62
Na	135.96	2.30	276.00	66.67
K	1.96	0.00	7.80	2.12

Table2: Correlation coefficients among water quality variables in Malayer

Groundwater quality parameters	Turbidity	pH	Chloride	TDS	Total hardness	Total alkalinity	Fluoride	Bicarbonate	Nitrite	Nitrate	Calcium	Magnesium	Sodium
Turbidity	1.00												
pH	<b>0.00</b>	1.00											
Chloride	0.06	0.07	1.00										
TDS	<b>0.44</b>	<b>0.74</b>	<b>0.74</b>	1.00									
Total hardness	<b>-0.12</b>	0.07	<b>0.69</b>	<b>0.80</b>	1.00								
Total alkalinity	<b>0.15</b>	0.00	<b>0.48</b>	<b>0.59</b>	<b>0.84</b>	1.00							
Fluoride	<b>0.04</b>	0.14	<b>0.55</b>	<b>0.46</b>	<b>0.40</b>	<b>0.35</b>	1.00						
Bicarbonate	<b>0.08</b>	0.05	<b>0.46</b>	<b>0.62</b>	<b>0.83</b>	<b>0.99</b>	<b>0.32</b>	1.00					
Nitrite	<b>0.96</b>	0.05	-0.03	<b>-0.54</b>	-0.14	0.11	0.03	0.03	1.00				
Nitrate	0.00	0.06	0.34	<b>0.49</b>	0.33	0.32	0.34	0.35	-0.08	1.00			
Calcium	0.01	0.07	<b>0.64</b>	<b>0.67</b>	<b>0.58</b>	<b>0.42</b>	0.32	<b>0.44</b>	-0.10	<b>0.66</b>	1.00		
Magnesium	0.07	0.19	-0.05	0.07	0.23	0.24	0.15	0.23	-0.02	-0.32	-0.04	1.00	
Sodium	0.07	0.20	<b>0.56</b>	0.26	0.03	0.00	<b>0.61</b>	0.01	0.00	0.18	0.15	-0.28	1.00

\*:significant correlation coefficients have been highlighted using bold fonts.

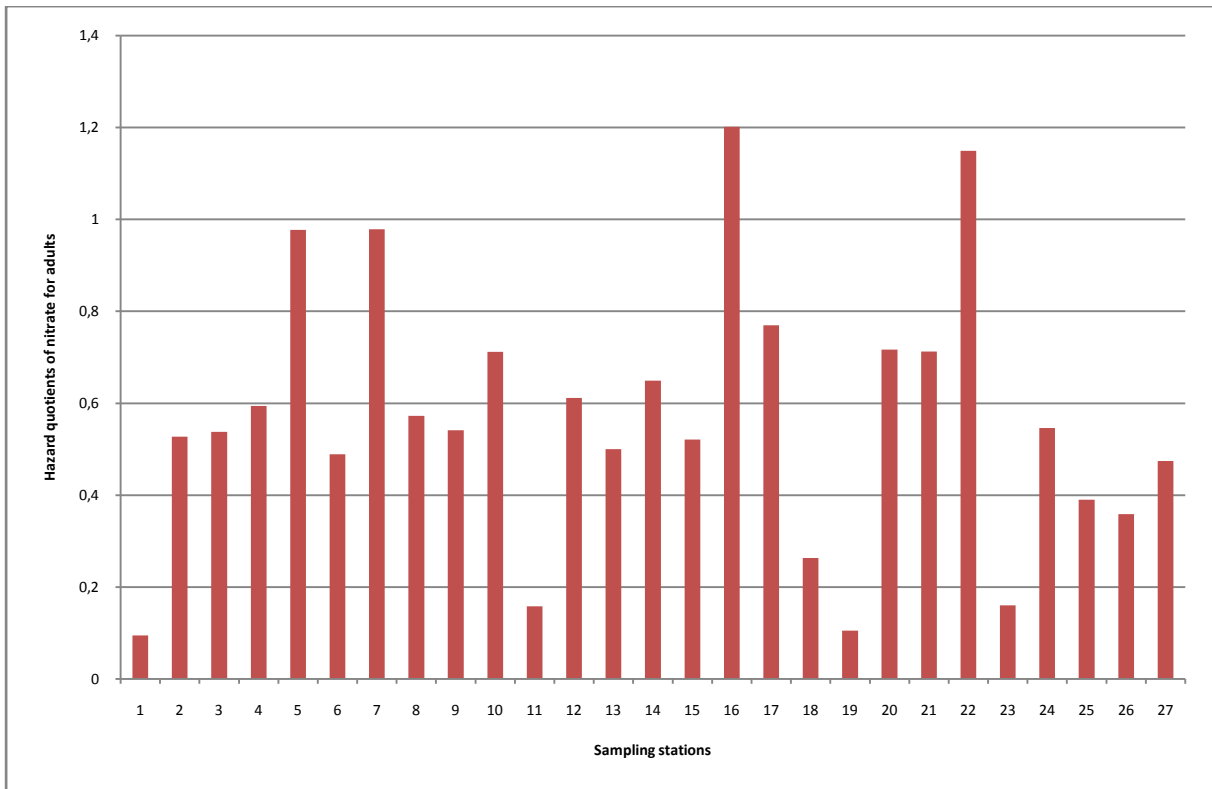

Figure1: Hazard quotients of nitrate for adults in the sampling wells

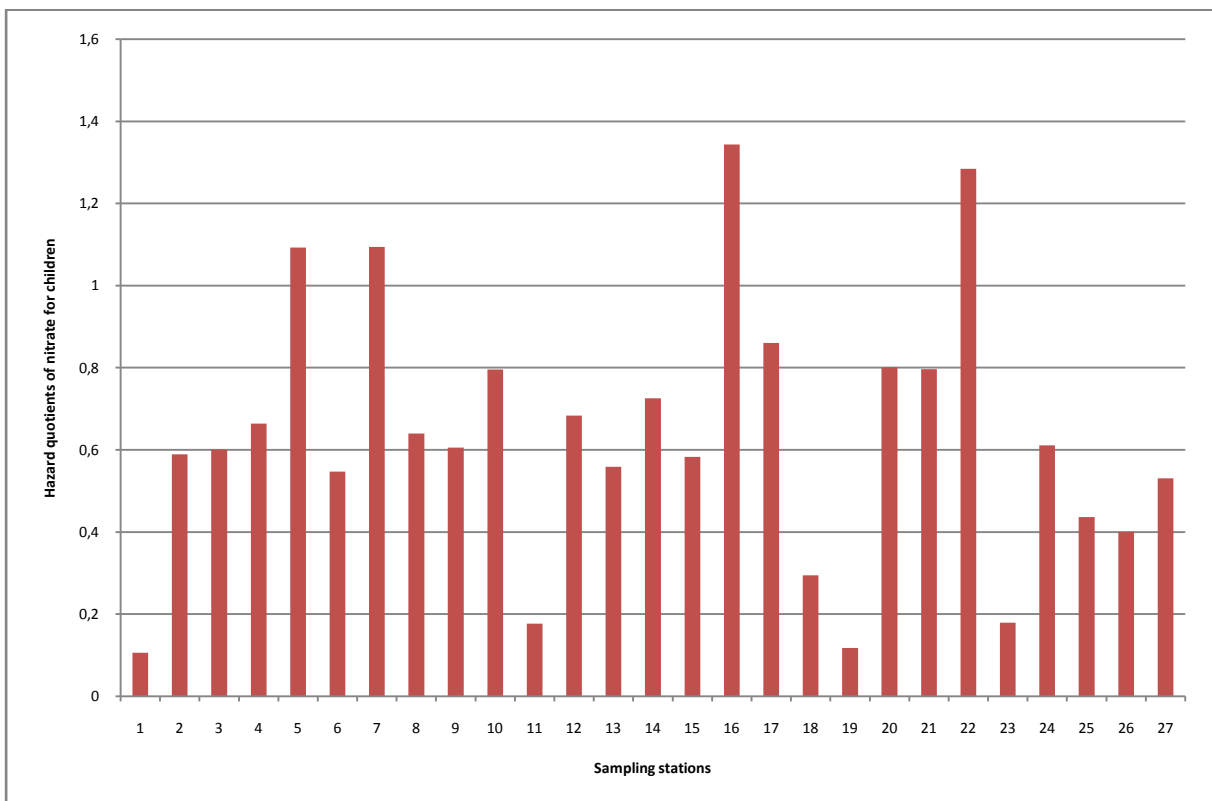

Figure2: Hazard quotients of nitrate for children in the sampling wells

The results of this study for fluoride are consistent with that of Rafati et al.(2013) in Hamedan Province where 49%percents of the samples were lower than the acceptable range. In a study conducted by Rahimi et al.(2013) on the groundwater resources of Shahroud and Damghan, nine out of ninety five drinking water samples(9.5 percents) had exceeded the standard level of 1.5mg/l and

the values ranged from 0.052 to 6.87 mg/l in the that research(Rahimi et al.2013).In another study on the distribution of fluoride in Maku Area, the level of fluoride in 14 out of 26(53.8percents) samples was higher than the permissible level of 1.5mg/l. These high levels were attributed to the occurrence of silicate minerals, apatite and fluorapatite, and the weathering of these minerals in the respective area (Moghaddam and Fijani 2008). There was a highly significant correlation between sodium and chloride with that of fluoride in the study conducted by Kundu et al.(2001) which is in agreement with that found in the current study(Table2).The sources of fluoride in groundwater are mainly from dissolution of geological formations but the process of dissolution is still not well understood (Saxena and Ahmed 2001). However, apart from natural sources, a considerable amount of fluoride may be attributed to anthropogenic activities such as application of phosphorus fertilizers in agricultural fields (Saxena and Ahmed 2003).

There are a number of anthropogenic sources for nitrate among them the most important one is intensive agricultural activities (Hamilton and Helsel 1995). These activities have been prevalent in the study area from the last few decades including vegetable and poultry production (Jalali and Kolahchi 2008).In addition, oxidation of ammonium in the unsaturated zone is another human induced source of nitrate in groundwater which is emanated from domestic and industrial activities and septic tanks, where urea and ammonium prevail over other nitrogen compounds (Jacks et al.1999). In this respect, there is a highly and significant correlation coefficient between calcium and nitrate( $r=0.66$ ). The linear relationship between  $\text{NO}_3$  and Ca reflects that Ca has the same origin as  $\text{NO}_3$ , that is, land surface (Kelly 1997).This conclusion was also found by other researchers (e.g. Chae et al.2004; Kim et al.2009).The applied fertilizers in the region may contain calcium as impurities. In this field, for example, manure, ammonium sulfate, and ammonium nitrate contain calcium as impurity(Bonton et al.2010).Moreover,as explained by Jalali and Kolahchi(2008) the addition of salt to animal food and application of their manures in agricultural fields is a possible source of chloride in the study area next to geological origin of this element. The highly significant correlation coefficient between Ca and Cl (Table2) highlights the fact they have possibly the same origin which is land surface as well. Another possible explanation for nitrate and calcium correlation is that nitrification enhances the dissolution of any carbonate minerals (e.g. calcite) naturally present in the sandy soil (Bonton et a.2010).In one of the related studies about the values of nitrate in groundwater resources of Hamedan(Jalali 2005), nitrate concentrations in the well samples varied from 3 to 252 with the average of  $49 \text{ mg l}^{-1}$ . Results showed that from 311 wells, 196 (63%) had levels less than  $50 \text{ mg l}^{-1}$  and 115 (37%) had levels in excess of the  $50 \text{ mg l}^{-1} \text{NO}_3^-$ .In another similar study, the nitrate levels in Mazandaran Province ranged between 20 and 137 mg/l which are higher than that found in the current study and these high values were attributed to the dominance of intensive agricultural activity in the area (Shahbazi and Esmaeili-Sari 2009).

Regarding the values of anions and cations, in a respective study in Razan, Hamandan(Jalali 2008) the chemical compositions of the groundwater were dominated by  $\text{Na}^+$ ,  $\text{Ca}^{2+}$ ,  $\text{HCO}_3^-$ ,  $\text{Cl}^-$  and  $\text{SO}_4^{2-}$ , which have been derived largely from natural chemical weathering of carbonate, gypsum and fertilizer's source.

With respect to the results of health risk assessment, if the risk is lower than one, there is not an immediate risk for the consumers while if the risk exceeds one there is a high risk for the health of consumers (Huang et al.2008).The hazard quotients of nitrate for adults varied between 0.09 and 1.20 and that of children fluctuated between 0.11 and 1.34,respectively.Two samples had exceeded the level of one for adults while this was four samples for children indicating that the children are at a higher risk than that of adults.

## CONCLUSION

Since the main source of drinking water for the local residents in rural area of Malayer is provided through ground water sources so, the health risk assessment of these resources is of great importance. In this study, the health risk of nitrate in children was higher than that of adults in a way two samples for the adults had a hazard quotient of over than one whereas this was four sampling stations for the

children. As the level of fluoride in groundwater was less than the permissible level in some stations so, it may incur dental decay in the local people.

## REFERENCES

- Bonton, A., Rouleau, A., Rouleau, C., Rodriguez, M.J.(2010) Assessment of groundwater quality and its variations in the capture zone of a pumping well in an agricultural area. *Agricultural Water Management*, 97,824-834.
- Chae, G.T., Kim, K., Yun, S.T., Kim, K.H., Kim, S.O., Choi, B.Y.(2004)Hydrogeochemistry of alluvial groundwaters in an agricultural area:an implication for groundwater contamination susceptibility. *Chemosphere* ,55,369–378.
- Dissanayake, C.B.(1991) The Fluoride Problem in the Groundwater of Sri Lanka-Environmental Management and Health. *International Journal of Environmental Studies*,38,137-156.
- Eckhardt, D.A.V., Stackelberg, P.E.(1995) Relation of groundwater quality to land use on Long Island, New York. *Ground Water* ,33,1019–1033.
- Fewtrell, L.(2004) Drinking-Water Nitrate, Methemoglobinemia, and Global Burden of Disease: A Discussion. *Environmental Health Perspectives* ,112 (14),1371-1374.
- Fytianos, K., Christophoridis, C.(2003) Nitrate, Arsenic and Chloride Pollution of Drinking Water in Northern Greece. Elaboration by Applying GIS. *Environmental Monitoring and Assessment* ,93(1–3),55-67.
- Hamilton, P.A.,Helsel, D.R.(1995) Effects of agriculture on groundwater quality in five regions of the United States.*Ground Water* ,33(2),217-226.
- Heller, K.E., Eklund, S.A., Burt, B.A.(1997) Dental caries and dental fluorosis at varying water fluoride concentrations. *Journal of Public Health Dentistry* ,57,136-43.
- Hem, J.D.(1985) Study and interpolation of the chemical characteristics of natural water. United States Geological Survey Water-Supply Paper 2254,pp. 1–263.
- Huang, M., Zhou, Z., Sun, B., Zhao, Q.(2008) Heavy metals in wheat grain: Assessment of potential health risk for inhabitants in Kunshan, China. *Science of the Total Environment* ,405,54-61.
- Kelly, W.R.(1997) Heterogeneities in ground-water geochemistry in a sand aquifer beneath an irrigated field. *Journal of Hydrology* ,198,154-176.
- Kim, K., Yun, S., Choi, B., Chae, G., Joo, J.(2009) Hydrochemical and multivariate statistical interpretations of spatial controls of nitrate concentrations in a shallow alluvial aquifer around oxbow lakes (Osong area, central Korea). *Journal of Contaminant Hydrology* ,107,114–127.
- Kundu, N.,Panigrahi, M.K.,Tripathy, S.,Munshi, S.,Powell, M.A.,Hart, B.R.(2001)Geochemical appraisal of fluoride contamination of groundwater in the Nayagarh district of Orissa,India.*Environmental Geology* ,41,451-460.
- Jacks, G., Sefe, F., Carling, M., Hammar, M., Letsamao, P.(1999)Tentative nitrogen budget for pit latrines-eastern Botswana.*Environmental Geology* ,38,199–203
- Jalali, M.(2005) Nitrates leaching from agricultural land in Hamadan, western Iran. *Agricultural Ecosystems and Environment* ,110(3-4),210-218.
- Jalali, M.(2007) Hydrochemical identification of groundwater resources and their changes under the impacts of human activity in the Chah Basin in Western Iran. *Environmental Monitoring and Assessment* ,130,347–364.
- Jalali, M.(2008) Geochemistry characterization of groundwater in an agricultural area of Razan, Hamadan, Iran. *Environmental Geology* ,56(7),1479-1488.
- Jalali, M., Kolahchi, Z.(2008) Groundwater quality in an irrigated, agricultural area of northern Malayer, western Iran. *Nutrient Cycling in Agroecosystems*,80,95–105.
- Nas, B., Berkday, A(2006) Groundwater contamination by nitrates in the city of Konya,(Turkey): A GIS perspective. *Journal of Environmental Management* ,79,30-37.
- Moghaddam, A.A.,Fijani, E.(2008) Distribution of fluoride in groundwater of Maku area, northwest of Iran. *Environmental Geology*, 56(2), 281-287.
- Qin, D., Qian, Y., Han, L., Wang, Z., Li, C., Zhao, Z.(2011) Assessing impact of irrigation water on groundwater recharge and quality in arid environment using CFCs, tritium and stable isotopes, in the Zhangye Basin, Northwest China. *Journal of Hydrology* ,405,194–208.
- Rafati, L.,Mokhtari, M.,Fazelinia, F.,Momtaz, S.M.,Mahvi, A.H.,2013. Evaluation of ground water fluoride concentration in Hamadan Province west of IRAN (2012). *Iran Journal of Health Sciences* ,1(3),71-76.
- Rahimi, M.,Ghorbani, H.,Naimi, R.,Rahimi, S.,Kafi, S.,Khosravi, A.A.(2013) Study on the fluoride in groundwater resources of Shahroud and Damghan and its relation with dental fluorensis with respect to medical geology. *Iranian Journal of Geology* ,88(4),3-13.In Persian.
- Saxena, V.K., Ahmed, S.(2001) Dissolution of fluoride in groundwater:a water–rock interaction study. *Environmental Geology*,40(9),1084–1087.

- Saxena, V.K., Ahmed, S.(2003) Inferring the chemical parameters for the dissolution of fluoride in groundwater.*Environmental Geology* ,43,731–736.
- Shahbazi, A., Esmaili-Sari, A.(2009) Groundwater quality assessment in north of Iran: A case study of Mazandaran Province.*World Applied Sciences Journal* ,5, 92-97.
- Su, X., Wang, H.,Zhang, Y.(2013) Health risk assessment of nitrate contamination in groundwater: A case study of an agricultural area in northeast China. *Water Resources Management* ,27,3025–3034.

V International Conference  
„ECOLOGY OF URBAN AREAS“ 2016

**APPLICATION OF NATURAL INORGANIC SORBENT (PEMZA) FOR  
REMOVAL OF CR(VI) IONS FROM WATER RESOURCES**

**Hamdije Memedi<sup>1\*</sup>, Katerina Atkovska<sup>2</sup>, Kiril Lisichkov<sup>2</sup>, Mirko Marinkovski<sup>2</sup>, Zoran Bozinovski<sup>3</sup>, Stefan Kuvendziev<sup>2</sup>, Arianit Reka<sup>1</sup>, Shaban Jakupi<sup>4</sup>**

<sup>1</sup>Faculty of Natural Sciences and Mathematics, State University of Tetovo,  
str. Ilindenn.n., 1200 Tetovo, Macedonia

<sup>2</sup>Faculty of Technology and Metallurgy, University “Ss. Cyril and Methodius”,  
Rugjer Boskovic 16, Skopje, Macedonia

<sup>3</sup>Public Enterprise, “Water Supply and Sewage”, Center for Sanitary Control, Skopje, Macedonia

<sup>4</sup>Ph.D. Student of University GoceDelchev, Stip, Macedonia  
klisickov@yahoo.com

**ABSTRACT**

*The heavy metals pollution is a serious environmental problem, especially the presence of the hexavalent chromium ions in the water resources. The removal of Cr(VI) from wastewaters is a necessity especially because of its toxicity for the living beings and the environment. Among viable options, natural inorganic materials are considered as possible sorbents for the heavy metal ions elimination. The aim of this work is to investigate the adsorption ability of pemza, natural mineral collected in Bojanciste, area in the south of the Republic of Macedonia, to remove chromium (VI) ions from aqueous solutions. In this study, adsorption capacity is analyzed using spectrophotometric method (UV/VIS Spectrophotometer). The adsorption experiment was performed at constant room temperature, different initial Cr(VI) ions concentrations and at different pH of the solution. The equilibrium data were analyzed by Langmuir isotherm and maximal adsorption capacity was determined. The following experimental techniques were used for pemza characterization: XRD, TGA-DTA and FT-IR. The surface area of the sorbent was measured by BET method. With aim to the determine the optimum pH value for maximal removal of Cr(VI) ions, the point of zero charge,  $pH_{PZC}$ , for investigated material was obtained. The results confirm the possibility of applying the natural material ,pemza, as effective and economic sorbent for heavy metals removal from water resources.*

**Key words:** heavy metal, Cr(VI) ions, pemza, adsorption, equilibrium .

**INTRODUCTION**

These days pollutants heavy metals from aqueous solutions are one of the biggest environmental problems because of their toxicity to human health. Cr (VI) is used in many industries such as: manufacturing of paints, metal works, manufacture of automobile parts and in the petrochemical industry (Chakir et al., 2002). Wastewater from these industries contain large amounts of chromium that is spread to the environment through land, water and eventually accumulate in the food chain. International Agency for Research on Cancer has classified as carcinogenic chromium (Biswajit et al., 2013). Hexavalent form is the most damaging for health due to carcinogenic and mutagenic properties. Limit of Cr (VI) in the waste water is only 0,05 mg/l (ATSDR, 2002). Therefore concentrations of Cr (VI) must be reduced to such an extent as to meet environmental regulations. Conventional methods for removal of ions of heavy metals from water and wastewater are chemical precipitation, ion exchange, electrochemical deposition, solvent extraction, membrane filtration and adsorption (Naiya et al., 2009). The removal of chromium, Cr (VI), is tried with adsorbents such as activated carbon (Srivastava et al., 1996), Spirogyra Biosorbents (Gupta et al., 2001), floating ashes (Bayat and Gupta 2004). They are also used by: soybean, tires, hazelnut shell, sawdust. In recent years, the elimination of heavy metals from wastewater is achieved by using certain types of natural or agricultural waste (Chatterjee et al., 2010, Khambhaty et al., 2009). Precisely the existence of these functional groups in organic adsorbents enables adsorption of Cr (VI). Also for this purpose in recent years they had explored effectively removing Cr(VI) using natural adsorbents that are cost effective

such as sunflower handle (Sun and Shi 1998), bark of Eucalyptus (Sarin 2006), bran of corn (Singh et al., 2006), shell of coconut, leaves of trees, shells of peanuts and nuts (Karthikeyan et al., 2005). The purpose of this study is to analyze the possibility of natural mineral pemza as sorbent for removal of Cr(VI) ions. Pemza and pumicite represent porous volcanic material obtained by expansion of volcanic lava under the influence of vapour and gas which has dissolved itself. Separation of pemza and pumicite is made based on the size of the grains. As pemza classified material to a size of grains larger than 2 mm up to large blocks and as pumicite material with size of grains beneath 2mm up to the finest powdery material. From a chemical point of view pemza and pumicite usually have a similar chemical composition and represent an acidic volcanic material in which the percentage of silicium dioxide usually ranges from 66-70%. Color occurs in various shades from light gray to dark gray, reddish, or brownish or yellowish. Geographical pemza in the world is quite widespread commercial bearings but not so widespread as in many case pemza lack the necessary physical and mechanical properties. Pumicite appears as a powdery material with grain size of 2 mm beneath until finely dispersed powdery material composed of small sharp grains of volcanic glass, so often found under the name of volcanic ash. Pemza is formed in powerful and explosive eruptions of volcanoes while ejecting large amounts of volcanic ash. In chemical composition and color pumicite is similar to pemza.

## **MATERIALS AND METHODS**

### **Pemza source**

The natural pemza used as adsorbent for Cr(VI) ions removal from aqueous solutions, is from deposit site called Bojanciste, near Kavadarci, Republic of Macedonia. The pemza samples in this study were used in their natural state without any treatment.

### **Adsorption experiment**

Standard solution of  $K_2Cr_2O_7$  with concentration of 1000 mg/l was used to prepare solution with initial Cr(VI) concentrations of 0.5 mg/l. This solution was placed in 11 beakers and 2.5 g of dry natural pemza was added into each beaker. The mixture of adsorbent and Cr(VI) solutions with different initial concentrations of 0.3, 0.4 and 0.5 mg/l, were stirred using magnetic stirrer at 400 rpm, at pH of the solution 2, at room temperature, for 3h sufficient time to reach equilibrium. pH of the solution adjusted by adding HCl solution as required. The samples were taken at particular time, filtered and filtrates were collected for analysis and the remaining Cr(VI) concentration was determined using UV-visible spectrophotometer using 1,5-diphenylcarbazide method as laid down in standard methods for examination of water and wastewater (APHA, AWWA, WEF 1998 edition). Also the remaining concentrations of Cr(VI) ions in the filtrate were determined using atomic absorption spectrophotometer, AAS Perkin Elmer model AA700. Experimental data were processed by Langmuir adsorption isotherm.

## **RESULTS AND DISCUSSION**

### **Characterization of the adsorbent**

Pemza from Bojanciste, Kavadarci represents volcanic glass with a certain percentage of crystallized crystalline phase. The physical characteristics of pemza are shown in Table 1.

Table 1. Physical characteristics of pemza

Characteristics	Pemza
Density (g/cm <sup>3</sup> )	2,45
Bulk density (g/cm <sup>3</sup> )	1,34
Grain bulk density (kg/m <sup>3</sup> )	
in strew form	1038
in compact form	1236
pH	6,25

From the results shown in Table 1, that the value of the density is 2,45 g/cm<sup>3</sup> and bulk density is 1,34 g/cm<sup>3</sup> can be concluded that pemza has high porosity. By the same results are coming and the values of grain bulk density of pemza (Pavlovski et al., 1981).

From a chemical composition pemza can be classified in the group of acidic silicate materials as the percentage of SiO<sub>2</sub> is 63.73%. The chemical composition of pemzaBojanciste is given in Table 2.

Table 2. Chemical composition of pemza [wt.%]

Oxides	Pemza wt.%
SiO <sub>2</sub>	63,73
Al <sub>2</sub> O <sub>3</sub>	17,48
Fe <sub>2</sub> O <sub>3</sub>	3,10
CaO	2,50
MgO	0,59
K <sub>2</sub> O	4,95
Na <sub>2</sub> O	4,45
SO <sub>3</sub>	-
LOI	3,07
Total	99,86

Mineralogical composition of the sample pemza is examined with X-ray structural analysis by Debye-Scherrer powder method. X-ray examinations were performed on powder method is used with a target copper and nickel filter. Tests were performed in range from 5-60°2θ.

Based on the X-ray diffractogram can conclude the following: pemza Bojanciste bulk of this sample represents roentgen amorphous mass of volcanic glass that has crystallized noble amount of crystalline phase.

The crystal phase is composed mainly of minerals from the group of plageoklazi and albite, oligoklas and anorthosite and the amount of potassium feldspati, orthoclase mikroklin. Something smaller quantities than in previous minerals are occurring minerals like quartz, biotite and augi. The results of X-ray examination of the pemza are presented in Figure 1.



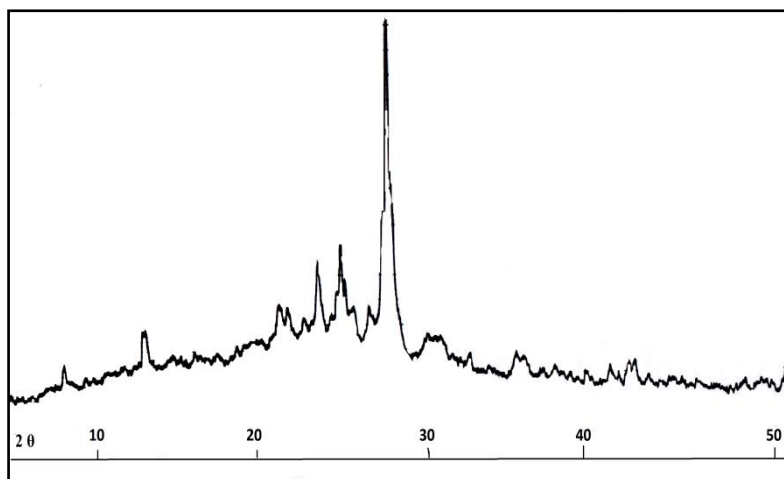

Figure 1. XRD of investigated material pemza

Fourier transform infrared spectra (FTIR) for pemza is presented in Fig. 2. From figure it can be concluded that adsorption bands at 1642, 1033 and 800  $\text{cm}^{-1}$  resulting from the present amorphous  $\text{SiO}_2$  in pemza. Bands at 442, 583 and 800  $\text{cm}^{-1}$  occur as a result of presence of volcanic glass (alkali aluminosilicate glass) in pemza. Bands at 550, 630 and 720  $\text{cm}^{-1}$  due to the present feldspati in pemza. Broad band at 3450 and 3617  $\text{cm}^{-1}$  resulting from the adsorption of pemza in water. While the strips 3450 and 3700  $\text{cm}^{-1}$  show the presence of hydroxyl groups in pemza.

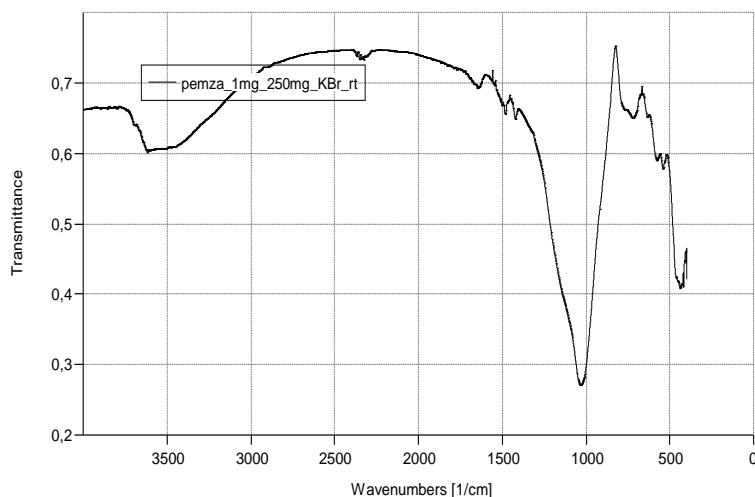

Figure 2. FTIR spectra of pemza

Differential thermal and thermogravimetric analysis of pemza Bojanciste is made of a powdery material. From the differential thermal and thermogravimetric curve of the test sample shown in Figure 3 can be inferred: pemza Bojanciste early intensive dehydration of the sample lies at 180° and ending at 350°C. As a result of intensive dehydration, the differential thermal curve occurs slightly set off endothermic peak. In this temperature range, the sample lost 79.3% of the total content of bound water. Within the temperature range of 350-480°C comes to the establishment of apparent equilibrium and then in the interval 480-720°C again comes to dehydration but much weaker compared with the same in the range of 180-350°C. Dehydration process practically finishes at 800°C.

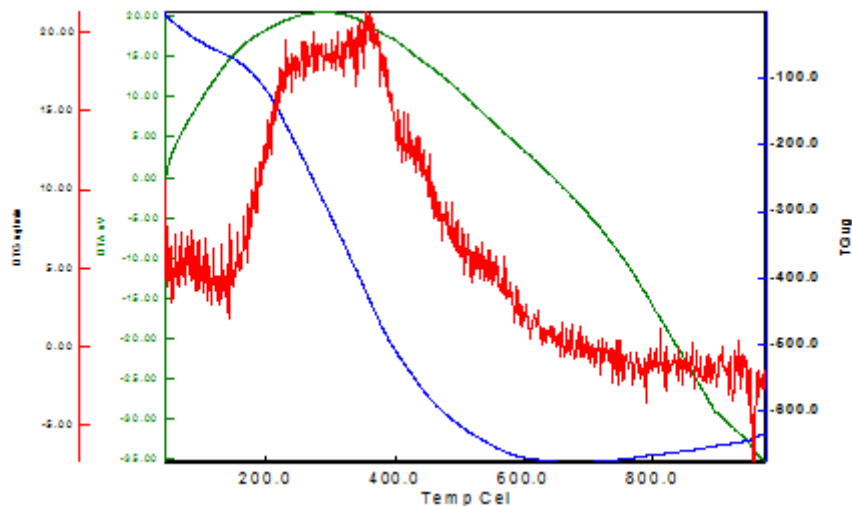

Figure 3. DTA/TGA of pemza

The point of zero charge of an adsorbent surface corresponds to the pH ( $pH_{pzc}$ ) at which the surface has a net natural charge. The point of zero charge of the samples is defined as the pH value of the plateau on the graph of dependence  $pH_{final}=f(pH_{initial})$ .  $pH_{pzc}$  for pemza is obtained, Fig. 4, and has value of 9.4. The  $pH_{pzc}$  represents that pH value above which the removal of cations will be favored. In this case, the optimal pH is in the range of 2 - 4, because chromium ions are in the form of  $HCrO_4^-$ .

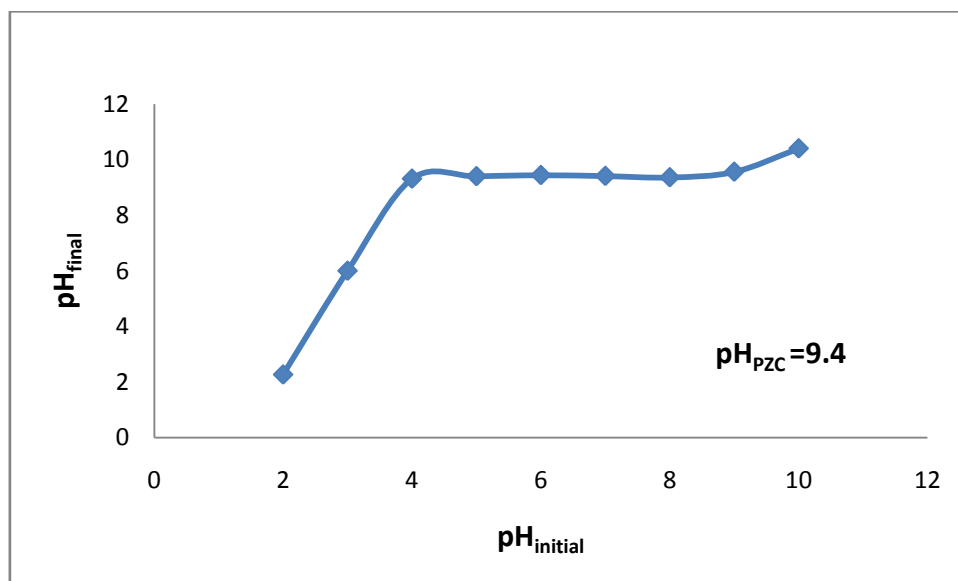

Figure 4. Point of zero charge of pemza

### Adsorption studies

The adsorption experiment was conducted at constant room temperature, pH of the solution 2 with an amount of pemza 2.5 g/l and initial metal ion concentrations of 0.5 mg/l.

The percentage of removal, %R, of Cr(VI) ions was calculated using the following equation:

$$\%R = \frac{C_0 - C_e}{C_0} \cdot 100 \quad (1)$$

where  $C_0$  is initial metal ion concentration [mg/l] and  $C_e$  is equilibrium concentration [mg/l].

The adsorbed amount of metal ion at equilibrium,  $q_e$  [mg/g], was calculated using the Equation 2.

$$q_e = \frac{(C_0 - C_e)V}{m} \quad (2)$$

where,  $V$  is volume of the solution [l], and  $m$  is mass of the adsorbent [g].

The effect of the initial concentration on the percentage of removal is shown in Figure 5. It can be seen from the figure that the removal percentage decreases with the increase in initial Cr(VI) ions concentration. At lowest initial metal ion concentration of 0.3 mg/l the percentage of removal is 63% after which it decreases gradually to 60 and 52% as initial concentration of Cr(VI) increases at 0.4 and 0.5 mg/l, respectively.

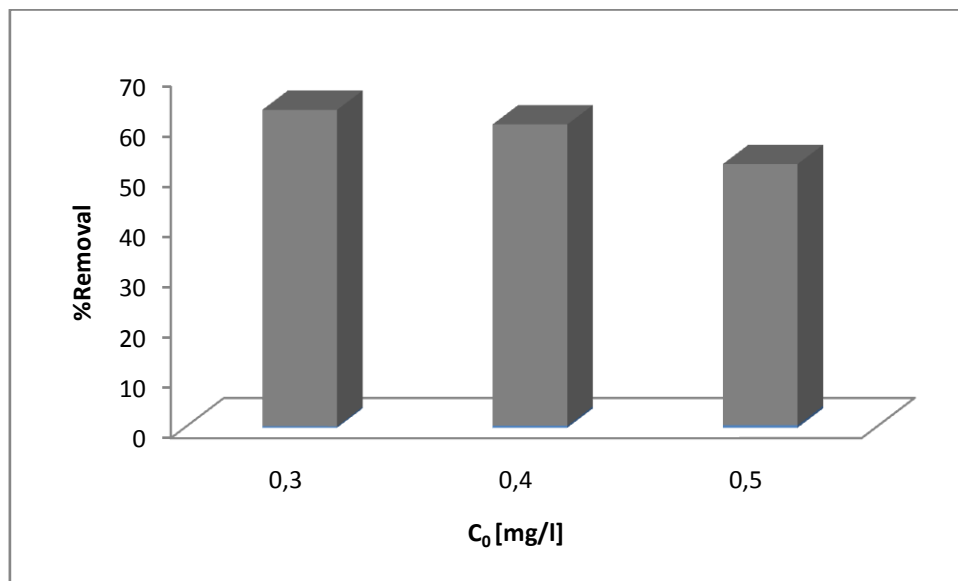

Figure 5. Function of Cr(VI) removal from initial concentration

Adsorption isotherms are important for adsorption processes research. Figure 6 shows the plot of adsorbed amount of Cr(VI) ions at equilibrium versus equilibrium concentrations.

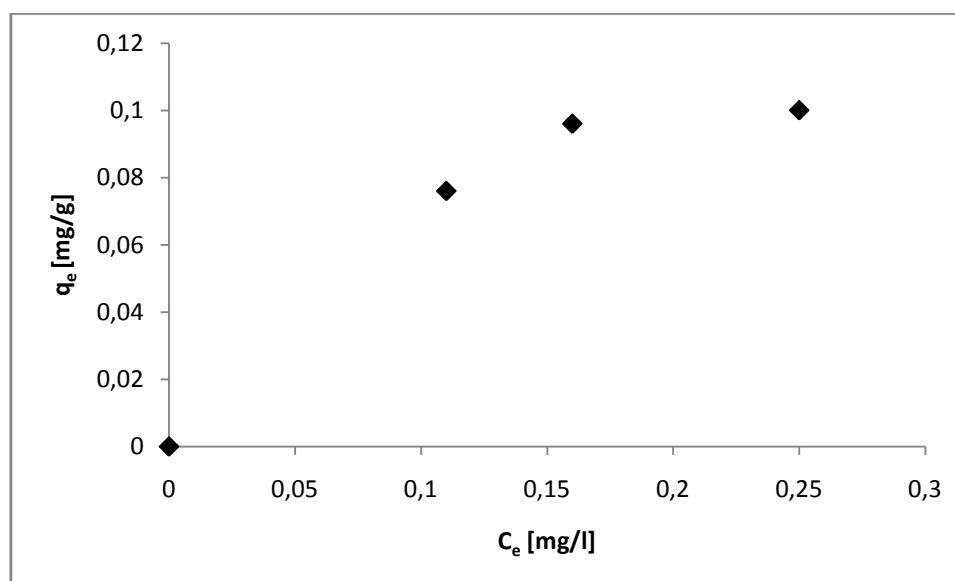

Figure 6. Experimental adsorption isotherm of Cr(VI) on pemza

Experimental data were processed by Langmuir isotherm. The Langmuir model, which is valid for monolayer adsorption onto a surface containing a finite number of identical sites, is the model most frequently used to represent data on adsorption from solution. The linear form of Langmuir equation is:

$$\frac{C_e}{q_e} = \frac{1}{q_m b} + \frac{C_e}{q_m} \quad (3)$$

where  $q_m$  is the monolayer adsorption capacity of the adsorbent [mg/g] and  $b$  is Langmuir adsorption constant related to the free energy of adsorption. Diagram of Langmuir adsorption model, obtained by using the experimental results, is shown in Figure 7. The values of  $q_m$  and  $b$ , determined from the linear form of the Langmuir equation and the Langmuir plot are 0.13 mg/l and 15.23, respectively, and the coefficient of correlation  $R^2$  is 0.997.

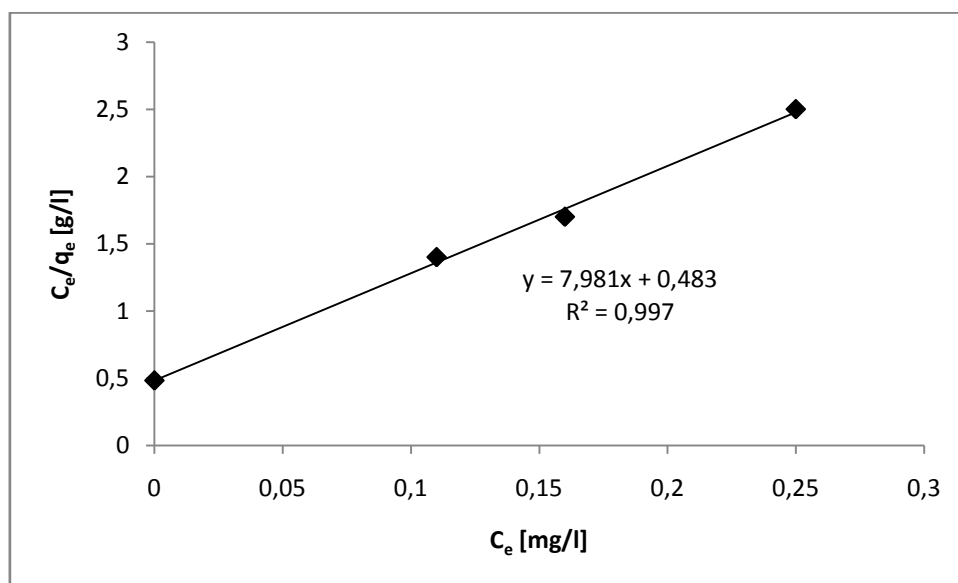

Figure 7. Langmuir adsorption model for Cr(VI) on pemza

The linearity of the plot confirmed by high value of correlation coefficient reveal that experimental results are well fitted with Langmuir isotherm.

## CONCLUSION

In this study, the adsorption of Cr(VI) on pemza was investigated. The adsorption characteristics have been examined at pH 2, 0.3, 0.4 and 0.5 mg/l initial metal ion concentrations, adsorbent dosages 2.5g/l. From a chemical composition pemza can be classified in the group of acidic silicate materials as the percentage of  $\text{SiO}_2$  is 63.73%. From X-ray diffractogram can be concluded that pemza Bojanciste bulk of this sample represents roentgen amorphous mass of volcanic glass that has crystallized noble amount of crystalline phase. The point of zero charge of the material was determined and the value is  $\text{pH}_{\text{PZC}} = 9.4$ . The removal percentage of Cr(VI) at different initial metal ion concentration was 63, 60 and 52% at 0.3, 0.4 and 0.5 mg/l concentrations, respectively. It was found that experimental results correspond well to the Langmuir isotherm model.

It can be concluded that pemza, an raw inorganic material, could be effectively used as low-cost adsorbent for the removal of chromium ions from aqueous solutions. The obtained results from this investigation shows that this natural adsorbent, with its characteristics, represents potential porous material for removal of heavy metals pollutants from different aqueous resources.

## REFERENCES

- APHA, AWWA, WEF, (1998). Standard methods for examination of water and wastewater, 20<sup>th</sup> Edition, Washington DC, New York.
- Bayat, B. (2002). Comparative study of adsorption properties of Turkish fly ashes II. The case of chromium (VI) and cadmium (II). *J. Hazard. Mater.*, 95, 275.
- Biswajit, D., Naba, K. M., Palas, R., Soumya, Ch. (2013). *Chem. Sci Trans.*, 2(1), 85-104
- Chakir, A., Bessiere, J., Kacemi, K.E.L., Marouf, B. (2002). A comparative study of the removal of trivalent chromium from aqueous solutions by bentonite and expanded perlite. *J. Hazard. Mater.* 95, 29.
- Chatterjee, S.K., Bhattacharjee, I., Chandra, G. (2010). Biosorption of heavy metals from industrial waste water by geobacillus thermodenitrificans. *Journal of hazardous Materials*, 175 (1-3), 117-125.
- Chiron, N., Guilet, R., Deydier, E. (2003). Adsorption of Cu(II) and Pb(II) onto a grafted silica: isotherms and kinetic models. *Water Res.*, 37, 3079.
- Gupta, V. K., Ali, I. (2004). Removal of lead and chromium from wastewater using bagasse fly ash a sugar industry waste. *J. Colloid Interface Sci.*, 271, 321
- Gupta, V.K., Gupta, M., Sharma, S. (2001). Process development for the removal of lead and chromium from aqueous solutions using red mud an aluminium industry waste. *Water Res.* 35, 1125.
- Gupta, V.K., Srivastava, A. K., Jain, N. (2001). Biosorption of chromium (VI) from aqueous solutions by green algae *Spirogyra* species. *Water Res.*, 35, 4079.
- Karthikeyan, T., Rajgopal, S., Miranda, L. R. (2005). Chromium (VI) adsorption from aqueous solution by *Hevea brasiliensis* sawdust activated carbon. *J. Hazard. Mater.* 124 (1-3), 192-199
- Khambhaty, Y., Mody, K., Basha S., Jha, B. (2009). Kinetics, Equilibrium and Thermodynamic Studies on Biosorption of Hexavalent Chromium by Dead Fungal Biomass of Marine *Aspergillus niger*, *Chemical Engineering Journal*, 145 (3), 489-495.
- Naiya, T.K., Bhattacharjee, A.K., Sarkar, D., Das, S.K. (2009). Applicability of shrinking core model on the adsorption of heavy metals by clarified sludge from aqueous solutions, *Adsorption*, 15, 354-364
- Sarin, V. (2006). Removal of chromium from industrial waste by using eucalyptus bark. *Bioresource Technol.* 97 (1), 15-20
- Singh K., Talat, K., Hasan, M.S.H. (2006). Removal of lead from aqueous solutions by agricultural waste maize bran. *Bioresource Technol.* 97 (16), 2124-2130
- Srivastava, S. K., Gupta, V. K., Mohan, D. (1996). Kinetic parameters for the removal of lead and chromium from wastewater using activated carbon developed from fertilizer waste material. *Environ. Modell. Assess.*, 1, 281.
- Sun, G., Shi, W. (1998). Sun flowers stalks as adsorbents for the removal of metal ions from wastewater. *Ind. Eng. Chem. Res.*, 37 (4), 1324-1328
- Wingenfelder, U., Nowack, B., Furrer, G., Schulin, R. (2005). Adsorption of Pb and Cd by amine-modified zeolite. *Water Res.*, 39, 3287.

V International Conference  
„ECOLOGY OF URBAN AREAS“ 2016

## THE APPLICATION OF EDUCATIONAL EQUIPMENT FOR WASTEWATER TREATMENT

**Marina Šćiban\*, Vesna Vasić, Dragana Kukić, Jelena Prodanović, Zita Šereš**

University of Novi Sad, Faculty of Technology Novi Sad, Bul. cara Lazara 1, 21000 Novi Sad, Serbia  
msciban@uns.ac.rs\*, vesnavasic@tf.uns.ac.rs, dkukic@uns.ac.rs, jejap@uns.ac.rs, zitas@tf.uns.ac.rs

### ABSTRACT

*This work is focused on analyzing operations of education equipment for aerobic process for wastewater purification. The experiments were performed on a laboratory device W11 aerobic reactor (Armfield). It is membrane bioreactor equipped with system for heating/cooling and aeration. Experiments were conducted on model water, prepared according to the manufacturer's recommendations. COD of model water was 2000 mgO<sub>2</sub>/L. Activated sludge for aerobic digestion were obtained from one municipal wastewater plant. Wastewater hydraulic retention time in reactor was 2,5 days. Based on the results obtained after aerobic digestion it can be said that good removal of organic matter was achieved. Removal efficiency of COD was in the range of 88 – 97%. In the second part of the experiment, when aeration was reduced, removal efficiency was in the range of 89- 97.5% which indicates that even in this case the amount of oxygen was sufficient for satisfactory growth of working microorganisms.*

**Key words:** wastewater, aerobic treatment, laboratory aerobic reactor.

### INTRODUCTION

Considering that the quantity of available fresh water are limited and the need for it increases, water begins increasingly to be re-used. In this way the quality of fresh water is becoming more closely related to the quality of waste water. In order to protect the recipients and the sources of fresh water, wastewater must be treated. Since the quality of wastewater varies widely depending of the origin, there is no common indicator (parameter) for all wastewaters. The standards are formulated on the basis of the whole range of parameters, such as: colour, turbidity, BOD, COD, pH, dry matter content, total suspended solids, concentration of heavy metals, nutrients, etc. (Gacesa and Klasnja, 1994).

Characterisation of wastewaters, such as determination of its origin, amount, the type and concentration of pollution etc., are very important data for calculating parameters necessary for assessing the impact of wastewaters on the environment. Also, this parameters are the basis for finding the optimal solution to the problem of wastewaters.

Discharge of untreated wastewaters into the recipient is one of the most critical environmental issues today. High COD and high nutrient content of the effluent may result in eutrophication of natural waters, while inappropriate disposal of wastewaters on the soil affects the groundwater quality by altering its physico-chemical properties and leading to significant level of soil pollution and acidification (Vasic et al., 2013).

Numerous processes and methods can be used for wastewater purification. Which methods will be used depends on amount and composition of wastewater, as well as whether it will be discharged directly in to the recipient, sewage system or to be used for some purposes. For wastewaters with high concentration of biodegradable organic matters, such as food industry wastewaters and municipal wastewater, the use of biological purification processes is inevitable. Most commonly used processes are aerobic treatment processes either with activated sludge or with attached biomass. Considering that mentioned processes work with mixed culture of microorganisms, they are very sensitive and pose a great challenge for operators in their successful conduct. Although the process of educating the engineers who are preparing for work in this field include many theoretical aspects of biological

processes of purification, it is useful to check their knowledge through practical work. This work is focused on analyzing operations of education equipment for aerobic process for wastewater purification. The experiments were performed on a Armfield laboratory device W11 aerobic reactor (<http://armfieldonline.com/en>).

## **THEORY**

### **Biological treatment processes**

Methods for wastewater purification include: preliminary treatment, primary, secondary and tertiary treatment, as well as treatment and disposal of solids and biosolids remaining after wastewater purification processes. In this paper the emphasis will be put on biological treatment processes, particularly on aerobic biological oxidation.

Biological purification processes are based on the activity of complex microorganisms. The removal of dissolved and particulate carbonaceous BOD and the stabilization of organic matter found in wastewaters is accomplished biologically using a variety of microorganisms, principally bacteria. Microorganisms are used to oxidize (convert) the dissolved and particulate carbonaceous organic matter into simple end products and additional biomass (Metcalf and Eddy, 2003). That way they remove the largest part of organic pollution in wastewater. Important factors which effect on efficiency of biological processes are: pH, temperature, content of nutrients and microelements, oxygen concentration, retention time etc.

Biological processes used for wastewater treatment can be divided into two main categories: aerobic oxidation processes and anaerobic oxidation processes. Aerobic processes are biological processes that occur in the presence of oxygen, while anaerobic processes are those that occur in the absence of oxygen. There are also anoxic processes by which nitrate nitrogen is converted biologically to nitrogen gas, in the absence of oxygen, and facultative processes in which the microorganisms can function in the presence or absence of oxygen. Various combinations of these processes can be grouped together to achieve specific quality of purified water.

### **Aerobic oxidation processes**

Aerobic purification process is much more prevalent than anaerobic. It is used in treatment of wastewater with small and medium concentration of organic pollution, ie. in the processing of low and medium loaded wastewater. Aerobic purification processes are divided into: suspended growth processes and attached growth (or biofilm) processes.

In suspended growth processes, the microorganisms responsible for treatment are maintained in liquid suspension by appropriate mixing methods. The activated-sludge process is so named because it involved the production of an activated mass of microorganisms capable for stabilizing a waste under aerobic conditions. In the aeration tank, contact time is provided for mixing and aerating influent wastewater with the microbial suspension (MLSS-mixed liquor suspended solids). Mechanical equipment is used to provide the mixing and transfer of oxygen into the process. The mixed liquor then flows to a clarifier where the microbial suspension is settled and thickened. The settled biomass (activated sludge) is returned to the aeration tank to continue biodegradation of the influent organic matters. A portion of the thickened solids is removed daily or periodically (Metcalf and Eddy, 2003).

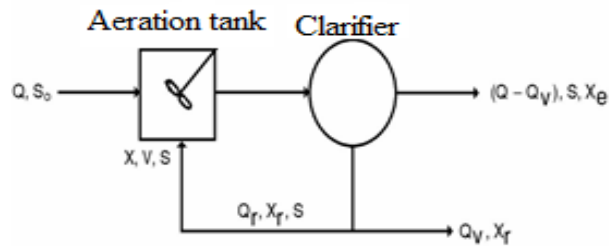

Figure 1. A simplified scheme of process for wastewater treatment with activated sludge (Gaćeša and Klačnja, 1994)

Activated sludge is biologically active biomass of aerobic microflora, which is in the form of flocs suspended in the wastewater. In the flocs the microorganisms other than live and dead cells are located as well as organic and inorganic substances from the wastewater to be purified. The waste water is introduced into the reactor, in which the activated sludge is maintained in suspension. Intermediate-aerobic activated sludge microflora perform simultaneous reactions of dissimilation (oxidation of organic matter), assimilation (synthesis of new cells microflora) and autooxidation reaction (endogenous respiration of cells microflora). The most common and the most important microorganisms are bacteria of the active sludge, as shown in Figure 2. These are generally Gram-negative bacteria genera: *Pseudomonas*, *Achromobacter*, *Flavobacterium*, *Nocardia*, *Mycobacterium*, and the nitrifying bacteria *Nitrosomonas* and *Nitrobacter* genera. Filamentous bacteria are also present. Microorganisms such as protozoa, rotifers and fungi, also have a very important role in wastewater treatment (Gaceca and Klasanja, 1994).

Since the wastewater treatment by activated sludge is very complex, it is useful to acquire practical knowledge on educational equipment like W11 aerobic reactor.

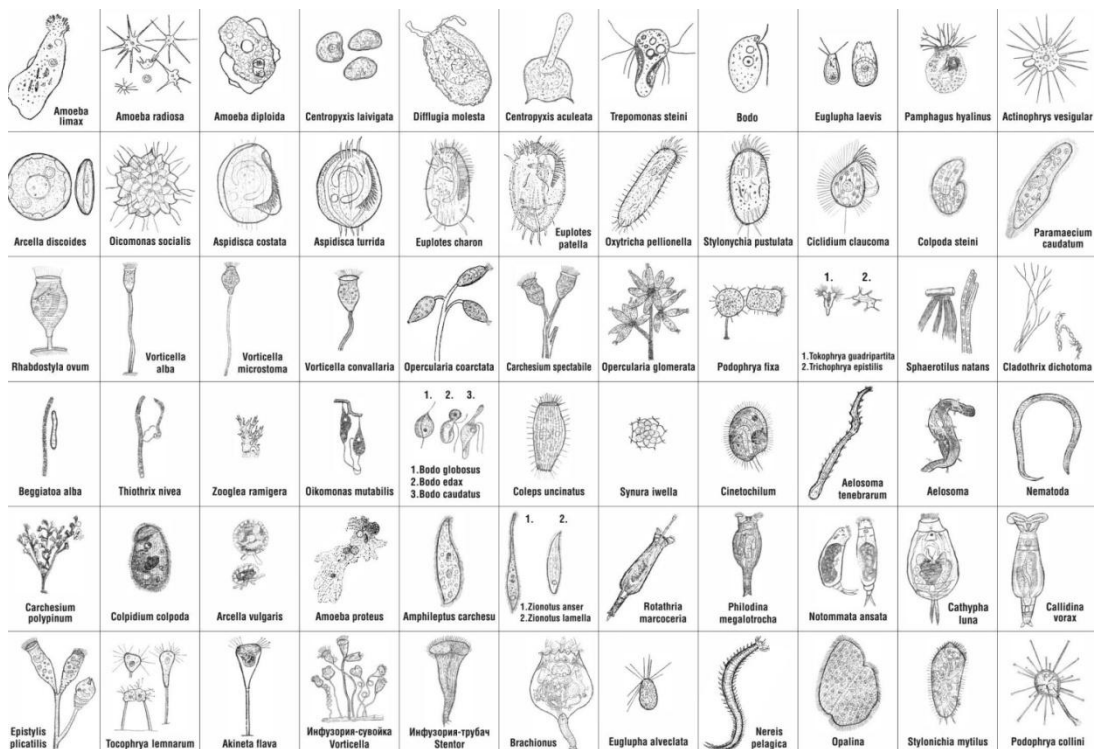

Figure 2. Microorganisms of activated sludge

([https://upload.wikimedia.org/wikipedia/commons/c/c3/Simplest\\_types\\_of\\_microorganisms\\_of\\_the\\_activated\\_sludge\\_%28Krivbassvodokanal%29.jpg](https://upload.wikimedia.org/wikipedia/commons/c/c3/Simplest_types_of_microorganisms_of_the_activated_sludge_%28Krivbassvodokanal%29.jpg))



## MATERIALS AND METHODS

### Materials

The experiment was performed with a model water which is prepared according to the manufacturer's recommendations. Model water consist glucose, bacterial peptone,  $\text{NH}_4\text{HCO}_3$ ,  $\text{KH}_2\text{PO}_4$ , and a small quantities of trace metals (Mg, Fe, Ca, K, Co). Model water was prepared every other day, considering that during time it deteriorates.

Activated sludge comes from one municipal wastewater plant in Serbia.

### Experimental procedure

Experiments were carried out on educational equipment for aerobic wastewater treatment *Aerobic Digester W11* (Armfield, England). Equipment is designed for students, for a better understanding of biological wastewater treatment process. With this apparatus, the students in the laboratories can reproduce industrial conditions and learn about the practical operation of the plant for the aerobic treatment of wastewater.

W11 aerobic reactor (Figure 3) consists of the bioreactor (1), capacity of 15 liters, with the sintered plastic membrane (2) which serves for the separation of activated sludge from the treated wastewater. The wastewater was insert in the aeration tank by peristaltic pump (11). The aeration was carried out by nozzles (4) placed at the bottom of the tank. Treated wastewater passes through the membrane and collected in the rim of bioreactor. The device is designed such that the flow of influent wastewater and the intensity of aeration can be varied. The bioreactor is equipped with heating and cooling systems, which allows to set the desired operating temperature.

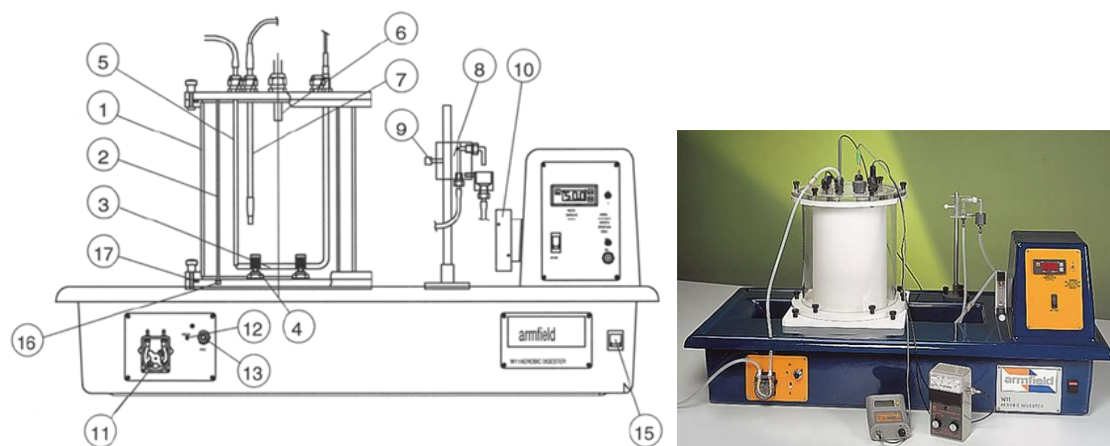

Figure 3. The aerobic reactor W11

(<http://discoverarmfield.com/en/products/view/w11/aerobic-digester>)

When the device is operating at maximum power, aerobic digester has a total working volume of 12.5 L. Regular operating volume is between 5 and 10 liters. A level adjusting device (8) allows the operating volume to be changed by simply releasing the screw (9). The membrane is designed to retain biomass, so only treated waste water passes through it and out of the reactor via connector in the base between the lining and wall of the reactor. Flexible seal at the base of the reactor provides that only treated waste water can be passed into the space between the lining and wall of the reactor. Heating

element (3) is placed in the base of the reactor, allows maintaining of desired temperature. A temperature sensor (7) transmits the temperature of the reactor contents to a three term controller in the console.

The bioreactor was filled with 7.5 liters of diluted suspension of the activated sludge and then model water was fed with the flow rate of 3.05 L/day. Influent is pumped to the base of the reactor by a variable speed peristaltic feed pump (11) through a dip leg (5). Hydraulic retention time was 2.5 days. The experiment was performed with aeration of 3 mg/L of air. The air which suspends and aerates the biomass is delivered by a small air pump (19) located at the rear of the console. A needle valve on the variable area flowmeter (10) is used to regulate the flow of air to the reactor. The air enters at the base of the reactor and passes through four diffusers (4) which distribute small bubbles evenly throughout the reactor contents. After 12 days membrane was replaced. The experiments continued under the same conditions, with aeration reduced to 1 mg/L. All experiments were carried out at a temperature of 25°C. During the work, temperature, pH, MLSS (Mixed Liquid Suspended Solids) and COD were monitored.

The dry matter content, chemical oxygen demand and suspended solids were determined by standard methods (APHA, 1998).

## **RESULTS AND DISCUSSION**

### **Analysis of activated sludge**

At the beginning of the experiment, the concentration of suspended particles (MLSS) in activated sludge was measured. According to the results of analysis it was found that MLSS was amounted 3.02 g/L. Activated sludge is diluted with demineralized water prior to entering bioreactor, so that the content of microorganisms, expressed by MLSS was about 2500 mg/L.

### **Results of aerobic treatment**

Results of analyses of model water and effluent are presented in Tables 1 and 2. As can be seen from table 1 and 2, the initial value of the chemical oxygen demand in model water was not always the same and ranged from 1,882 to 2,246 mgO<sub>2</sub>/L. This can be explained by the fact that fresh model water was prepared repeatedly. The pH of the reactor liquid was not varied significantly. pH range recommended by the manufacturer is spontaneously maintained in the reactor, so there was no need to add chemicals. COD of treated water was varied in the range from 51 to 244.4 mg/L. However, good removal efficiency was achieved. In the first part of the experiment it was ranged from 88 to 97%, calculated throughout the COD. In the second part of the experiment (after the membrane was replaced) when aeration was reduced, removal efficiency ranged from 89 to 97.5%, which means that even in this case the concentration of oxygen was sufficient for satisfactory growth of microorganisms.

*Table 1. Results of analyses of activated sludge, model water and effluent (before replacement of membrane)*

Day	Temp. (°C)	Air flow (mg/l)	MLSS (mg/l)	COD model water (mg/l)	COD effluent (mg/l)	Efficiency (%)	pH model water	pH effluent	pH activated sludge
1	25	3	1,417	2,246					
2	25.1	3	-	2,246	156.8	93.02		7.39	
3	25	3	-	2,136	172.5	91.93		7.05	
4	25.4	3	3,020	2,078	141.1	93.21		7.07	
5	25	3	-	2,117	66.6	96.85	6.93	7.31	
6	25.1	3	3,290	2,071	62.5	96.98	6.50	7.27	
7	25	3	-	1,915	108.6	94.33	6.88	7.24	
8	25	3	3,748	1,915	62.5	96.73	4.90	7.16	
9	25.1	2	-	1,882	78.4	95.83		7.18	
10	25	1,5	-	2,038	109.8	94.61		6.97	
11	25	1,5	2,200	2,038	219.5	89.23		7.27	7.57
12	25.1	0,5	2,040	2,037	244.4	88.00	7.12	7.55	7.54

*Table 2. Results of analyses of activated sludge, model water and effluent (after replacement of membrane)*

Day	Temp. (°C)	Air flow (mg/l)	MLSS (mg/l)	COD model water (mg/l)	COD effluent (mg/l)	Efficiency (%)	pH model water	pH effluent	pH activated sludge
1	24.9	1	2,980	2,169	232.9	89.26	7.20		7.34
2	25	1	2,920	2,092	131.5	93.71	7.09	7.67	6.98
3	25.1	1	2,700	2,184	150.8	93.1	7.17	7.49	6.14
4	25	1	-	2,016	199.2	90.12	6.08	7.07	
5	25	1	3,359	1,992	119.5	94	7.17		7.42
6	25.2	1	3,539	2,052	51.5	97.49	6.99	7.57	7.29
7	25.6	1	3,087	2,130	125.1	94.13	6.90	7.39	7.18
8	25.4	1	2,552	2,050	97.7	95.23	6.86	7.75	7.08
9	25.1	1		2,071	91.6	95.58	6.89	7.91	6.89

As could be seen in Tables 1 and 2, the suspended solid contents (MLSS) in the reactor liquid was increased over time, which means that the number of microorganisms was significantly increased, but to a certain extent.

After membrane contamination due to fouling, reactor liquid level begins to rise, which leads to dilution of the suspension. This is reflected in a reduced concentration of suspended solids. Considering that the membrane was blocked it was necessary to replace it.

Total duration of the experiment was three weeks, which was enough for basic students exercises and understandig how these facilities work.

## CONCLUSIONS

Based on the results obtained after aerobic digestion it can be said that good removal of organic matter was achieved. Removal efficiency of COD was in the range of 88 – 97%. In the second part of the experiment, when aeration was reduced, removal efficiency was in the range of 89- 97,5% which indicates that even in this case the amount of oxigen was sufficient for satisfactory growth of microorganisms.

During the time content of suspended solids increases, so that the load of organic matter per unit of micro-organisms was gradually decreased from 0.365 to 0.210 mg/mg day. pH of the reactor liquid was not varied significantly and it was in the range recommended by the manufacturer.

Based on the presented results it can be concluded that aerobic reactor can be successfully use for reproduction of industrial conditions in the laboratory.

## REFERENCES

- APHA (American Public Health Association) (1998), *Standard Methods for the Examination of Water and Wastewater*, 20th ed., APHA, AWWA, WEF, Washington DC.
- Gaćeša, S., Klačnja, M. (1994), *Water and Wastewater Technology* (in Serbian), *Jugoslovensko udruženje pivara*, Beograd.
- Metcalf & Eddy. (2003), *Wastewater Engineering - Treatment and Reuse*, 4<sup>th</sup> ed. New York, McGraw-Hill Education.
- Vasic, M. V., Prodanovic, M. J., Kukic, V. D., Sciban B. M., Antov, G.M. & Ivetic, D. Z. (2013), Application of membrane and natural coagulants for stillage purification. *Desalination and Water Treatment*, 51 (1-3), 437–441.
- <http://armfieldonline.com/en>
- <http://discoverarmfield.com/en/products/view/w11/aerobic-digester>
- [https://upload.wikimedia.org/wikipedia/commons/c/c3/Simplest\\_types\\_of\\_microorganisms\\_of\\_the\\_activated\\_sludge\\_%28Krivbassvodokanal%29.jpg](https://upload.wikimedia.org/wikipedia/commons/c/c3/Simplest_types_of_microorganisms_of_the_activated_sludge_%28Krivbassvodokanal%29.jpg)

V International Conference  
„ECOLOGY OF URBAN AREAS“ 2016

## NOVEL TRENDS IN WASTEWATER TREATMENT BY USING MEMBRANE BIOREACTORS

Erhan Mustafa<sup>1\*</sup>, Kiril Lisichkov<sup>2</sup>, Mirko Marinkovski<sup>2</sup>, Stefan Kuvendziev<sup>2</sup>, Zoran Bozinovski<sup>3</sup>

<sup>1</sup>Ph.D.Student of Faculty of Technology and Metallurgy, University “Ss. Cyril and Methodius”,  
RugjerBoskovic16, Skopje, R.Macedonia

<sup>2</sup>Faculty of Technology and Metallurgy, University “Ss. Cyril and Methodius”,  
RugjerBoskovic 16, Skopje, R.Macedonia

<sup>3</sup>Public Enterprise, “Water Supply and Sewage”, Center for Sanitary Control, Skopje, R. Macedonia  
erhanmustafa1978@gmail.com;klisickov@yahoo.com

### ABSTRACT

*Our society generates wastewater from domestic and industrial origin. The treatment of the wastewater and reducing the pollutants that have negative effect on ecosystems of the recipients is a major challenge for the last 100 years. Although there are lot of different treatment steps depending of the composition and origin of the wastewater, most of them follow the order of mechanical, chemical and biological treatment. The quality of the effluent from the wastewater plant is very important since the local regulations of the outgoing parameters are getting tighter. The membrane technology which is part of the biological treatment allows high quality effluent. It is a filtration of active sludge generated from the wastewater, thus allowing high operating sludge concentrations and low suspended solids in the filtered water. The membrane material can be from different origin (polymers, ceramic, metal) with different pores size and structures affecting the wastewater plant effluent quality. Our aim is to measure the concentration of dissolved oxygen, pH and conductivity of the effluent. The membranes in the MBR reactor are made from PVDF material with PET non-woven fibre that has high mechanical strength and high chemical resistances against chlorine, Acid and strong oxidation agents. The membranes have nominal pore size of 0.08 micrometers. The MBR plant has been operating for 5 years. The membrane configuration is composed of flat sheet type PVDF membrane panels mounted in two modules, each holding up to 100 pieces. The operating filtration flow is 15 to 21 liters/m<sup>2</sup>/hour and works with gravitation filtration. The module material supporting panels are made from ABS resin.*

**Key words:** Membrane, Wastewater, MBR, Active sludge

### INTRODUCTION

The availability of drinking water is becoming severely limited in the past decade and the quality of the remaining water supplies are rapidly reducing. Untreated sewage wastewater released in the recipient is deteriorating the water quality of the recipient. The need for the treatment of the waste water and reducing its pollutants is necessary more than ever. Large urban areas generate high quantities of wastewater that need treatment plants with large footprint. As the technology is rapidly developing new solutions emerges. In over populated areas the need for space is necessary and expensive the processes of wastewater treatment using membrane is becoming more attractive. Because of the high operating MLSS concentrations in the biological reactor smaller wastewater plant space is required. The MBR systems combine the convectional active sludge system and membrane filtration processes acting as one whole system, providing high quality treated and filtered water. The high MLSS concentration provides efficient BOD<sub>5</sub> and COD removal and the MBR reactor acting as the filter reduces suspended solids in the effluent to very low levels. The possibility of adding ultra filtration at end of the process and after that using revers osmosis membranes gives whole new meaning to the wastewater treatment processes.

## MATERIAL AND METHODS

### MBR reactors characteristics

The MBR reactors are replacing secondary settling tanks in convectional activated sludge systems. In the MBR reactors membranes are used to separate active sludge and solids from the treated water. Generally membrane processes can be classify depending on the pore size,membrane type and materials,module and structure. According to the pore size commercially available membrane separation processes can be divided to Ultra filtration (0,002-0,1 micrometers),Micro filtration (0,1-0,2 micrometers) and Nano filtration(0,0001-0,001micrometers).

The filtration processes using commercially available membrane modules in MBR systems are of two types:

- 1.Submerged filtration -Using submerged module in the active sludge.
- 2.Side stream filtration -Using side stream module outside of the reactor.

The submerged membrane module filtration is done using gravitation forces or a suction pump, as the side stream filtration is pressure driven filtration. The main difference is the high flux and MLSS concentration of side stream filtration compared to submerged processes but also because of that side stream membranes are more prone to membrane fouling than the submerged membrane configuration systems.

### Case of study

The study area is a MBR plant with two bio reactors,each capable to treat 75 m<sup>3</sup> domestic wastewater. Samples of the wastewater were taken and measured on site using portable laboratory equipment. The MBR reactors are working with submerged flat sheet membrane modules. There are two membrane modules in one MBR reactor. Each module has 100 pieces of flats sheet membranes with effective surface area of 90 m<sup>2</sup>.The filtration is done by gravitation as the ratio of filtration and relaxation of the membranes is five to one. The membrane plates are made from PVDF material and PET non woven fabric supported on ABS panel. The membrane main pore size are of 0.08 micrometers.



Figure 1. Submerged MBR module with PVDF membranes

The operating membrane MLSS should be between 7,000 – 18,000 milligrams per litre, with tendency to keep it 15,000 milligrams per litre. The bio reactor MLSS is keep at 12,000 milligrams per litre. The plant has been operating for the last five years.

*Table 1. Five year average BOD 5 ,COD measurements (Central laboratory Ministry of Environment)*

	Influent	Effluent	Reduction %
BOD 5 [mg/l]	281.92	19.69	93
COD [mg/l]	634.18	61.59	90.2

The MBR filtration rate is half of its capacity and now one MBR reactors produces 65 cubic meters treated water per day .The solid retention time is fixed on 28 days with daily wasting of active sludge from the reactor.

## RESULTS AND DISCUSSION

For our purposes samples were taken from real operating MBR system installed on urban area in R.Macedonia. Measurements were made to the incoming wastewater, in the biological reactor and effluent using Lutron portable laboratory device. The following parameters were measured: pH,oxidation-reduction potential,conductivity and temperature. For measurement of the oxidation-reduction potential (ORP) electrode model ORP-14 was used. Its measuring range is from -2,000 mV to +2,000 mV. The conductivity has been measured with CDPB-03 probe. It is calibrated with Lutrons CD-14 calibration solution giving specific calibration reading of 1.413 ms. For calibration of pH, Fluke buffer solution were used. According to three pH points of pH=4,pH=7 and pH=10 calibration has been made.The dissolved oxygen probe has been calibrate as instructed by Lutron. As the oxygen in air is 20.9 % typically, we have used the environment air value for quick and precise calibration. For dissolved oxygen measurements the probe has been immersed to a depth at least 10 cm of the measured liquid in order for the probe to be influenced by the temperature and automatic temperature compensation to take place.

The measurements are made as fallow:

*Table 2.Characteristics s of Incoming wastewater to the WWTP*

Input Wastewater	I series	II series	III series
pH	8,56	8,11	7,36
Conductivity mS	1995	2360	2020
Dissolved oxygen [mg/l]	0,7	0,9	/
ORP [mV]	-320	-353	-327

*Table 3.Characteristics of Bio reactor active sludge*

Bio reactor	I series	II series	III series	IV series
Dissolved oxygen [mg/l]	1,9	4,1	3,8	3,9
ORP [mV]	62	166	138	152
Temperature s	23	20,5	20,5	19,6

*Table 4.Characteristics of effluent water*

Effluent	I series	II series	III series
pH	7,6	6,97	6,93
Conductivity mS	1675	1680	1693
Dissolved oxygen [mg/l]	2	3,0	3,1
ORP [mV]	49	136	137

Physical and chemical characteristics of the incoming and incoming wastewater and effluent are shown on table 2 and 4, respectively. Raw wastewater influent has a typical ORP of -200 mV. A strong influent measures approximately -400 mV, and weak influents (such as those containing infiltration and inflow) measure -50 mV (Water Environment Federation .2007) . In the suspended growth system such as convectional active sludge systems, a well-oxidized active sludge can be affected by a strong organic waste load. An ORP test can indicate the reserve capacity available to maintain treatment process. Anoxic conditions, controlled by the ORP, use nitrates instead of oxygen, thereby reducing blower usage. The ORP is used to prevent slipping from anoxic to anaerobic conditions, which would generate odors. The ORP measures the potential of the treatment system. It can identify current operational conditions. It can provide an immediate response to critical controls. Redox potential is measured using a data logging meter and an ORP submersible probe. It can be used to monitor incoming raw wastewater, primary effluent, suspended growth systems, fixed-film systems, and aerobic digesters.(Water Environment Federation 2007).



*Figure 2. Wastewater sample and sample point before the MBR Plant*

On figure 2 are shown sample taking equipment, places where incoming wastewater samples were taken. The pH scale ranges from 1 to 14, with a neutral reading of 7. The pH is very important in biological wastewater treatment, because the microorganisms remain sufficiently active only within a narrow range, generally between pH 6.5 and 8. Readings below 7 indicate an acidic condition, and those above 7 indicate a basic condition. Outside this range, pH can inhibit or completely stop the biological activity. Nitrification reactions are especially sensitive to pH changes. Biological activity declines to near zero at a pH below 6.0 in unadapted systems.(Bitton,Gabriel.2005)

Conductivity measures the ability of an aqueous solution to carry an electrical current. The conductivity of domestic wastewater generally ranges from 50 to 1500 S/cm, although some industrial wastewaters have conductivities higher than 10 000 S/cm.(Water Environment Federation 2007).The conductivity of wastewater indicates the quantity of dissolved inorganic material present in the water.





Figure 3. Part of the biological reactor sample points and effluent sample taken point

On figure 3 are shown places or points where samples were taken. The first picture is the active sludge bioreactor, following the aeration and effluent excess valve. Dissolved oxygen (D.O.) in the aerated activated-sludge process is necessary for sustaining life, including living bacteria colonies that oxidize waste to obtain energy for living and growth. The key is to aim dissolved oxygen levels in the biological reactor that won't suppress the biological reactions in the active sludge. Generally accepted is a minimum of 2 ppm of dissolved oxygen in the active sludge bio reactor.

## CONCLUSION

The incoming waste water ORP values correspond to values of strong wastewater influent. In the bio reactor even with high aerated activate sludge concentration (15,000 milligrams per liter) and with oxygen levels above 2 ppm, normal biological processes continue as in the conventional activated sludge systems. The MBR system ORP value is measured in nitrification range and corresponds to biological oxidation of organic matter and ammonium to nitrite and nitrate.

Wastewater conductivity is reduced for 21 %. Conductivity is connected to the total ions in the water. The reduced conductivity of the effluent is due to ammonium nitrogen removal and consumed alkalinity during the biological process in the active sludge. The pH values are in levels that are suitable for micro-organism living.

The MBR system is a promising technology that can upgrade future conventional sludge systems and due to high concentration of MLSS can take high load of organic waste and can treat higher volumes of wastewater as its need for space is much smaller than the conventional systems.

Generally we can say that MBR process has smaller footprint, high MLSS concentrations, low suspended solids in the effluent, low COD values compared to conventional activated sludge systems (SBR, RBC and etc.)

## REFERENCES

- Bitton, Gabriel. (2005). *Wastewater microbiology*, 3<sup>rd</sup> edn, Microbiology in wastewater Wiley pub.
- Judd, Simon. (2011). *The MBR Book Principles and Applications of membrane bioreactors for water and wastewater treatment*, 2<sup>nd</sup> edn, Butterworth-Heinemann pub
- Levlin E., (2007). *Conductivity measurements for controlling municipal waste-water treatment*.
- Metcalf & Eddy, Inc. (2003) *Wastewater Engineering, Treatment and Reuse*, 4th ed.; Tchobanoglous, G., Burton, F. L., Stensel, H. D., Eds.; McGraw-Hill: New York.
- Water Environment Federation (1993) *Instrumentation in Wastewater Treatment Facilities*, Manual of Practice No. 21; Water Environment Federation: Alexandria, Virginia.
- Water Environment Federation (2007) *Characterization and sampling of waste water*, chapter 17.

V International Conference  
„ECOLOGY OF URBAN AREAS“ 2016

## BAUXITE BASED GEOPOLYMER AS A NOVEL ADSORBENT FOR HEAVY METALS REMOVAL FROM AQUATIC SOLUTIONS

Irena Nikolić<sup>1</sup>, Milena Tadić<sup>1</sup>, Ivana Milašević<sup>2\*</sup>, Dijana Đurović<sup>3</sup>, Zoltan Kazi<sup>4</sup>,  
Bogdana Vujić<sup>4</sup>

<sup>1</sup>Faculty of Metallurgy and Technology, University of Montenegro, Džordža Vašingtona bb, 81000 Podgorica, Montenegro

<sup>2</sup>Centre of Excellence in Bioinformatics, Faculty of Electrical Engineering, University of Montenegro, Džordža Vašingtona bb, 81000 Podgorica, Montenegro

<sup>3</sup>Institute of Public Health of Montenegro, Džona Džeksona bb, 81 000 Podgorica, Montenegro

<sup>4</sup>University of Novi Sad Technical Faculty "Mihajlo Pupin", Djure Dajovića bb, 23000 Zrenjanin, Serbia  
irena@ac.me, ivanamilasevic@gmail.com, dil@t-com.me, zoltan.kazi@gmail.com

### ABSTRACT

*New materials, bauxite based geopolymer (BXG) were prepared and used for a removal of Cu<sup>2+</sup>, Zn<sup>2+</sup>, Cr<sup>2+</sup> and Cd<sup>2+</sup> ions from aquatic solution. The effect of sorbent dosage and contact time on the simultaneously removal of heavy metals were explored. The results have shown that, optimal sorbent dosage is 0.8 g/l and that the adsorption equilibrium was reached after 30 min. Moreover, the higher removal efficiency was observed for Cu<sup>2+</sup> and Cr<sup>2+</sup> in comparison to Zn<sup>2+</sup> and Cd<sup>2+</sup> at the same experimental conditions.*

**Key words:** low grade bauxite, geopolymer, heavy metals, adsorption, aquatic solutions.

### INTRODUCTION

Pollution with heavy metals is reported as a growing problem in an industrialized country because these metals are non-biodegradable and thereby resulting in their persistence and accumulation in soil (Bolan et al. 2014). In this sense, it is necessary to effectively remove toxic heavy metal ions from industrial effluents before releasing them into the environment. Different methods have been used for the removal of toxic metals from wastewater but adsorption is regarded as one of the most promising methods due to the simplicity and flexibility (Ünlü and Ersoz 2006). Activated carbon is widely used for this purpose but the high cost imposes the necessity to find the alternative for the removal of heavy metals from waste waters.

Recently, a novel adsorbent for purification of waste waters have attracted a special attention. Many carbon nanomaterials, such as carbon, nanotubes and graphene (Wang at al., 2008; Deng at al., 210) have been proposed to remove various organic pollutants and heavy metals from wastewater. Moreover, a novel "green adsorbent" based on agricultural by products like bagasse fly ash (Chuah at al.,2006) peanut hull (Ali at al. 2016), zeolite, clays (Bailey at al., 1999), and coal fly ash (Heechan at al.,2005; Mohan and Gandhimathi 2009 ) have been proposed.

Currently a special attention has been paid to the use of geopolymers for waste water purification. These new materials are considering as an alternative to cement binder due to the enhanced environmental performance. Fly ash and metakaolin are mainly used as raw materials for geopolymers synthesis and adsorption of heavy metals from aquatic solution (Al-Zboon at al., 2011; Ge at al., 2015).

In this sense, the aim of this research was to (1) prepare and bauxite based geopolymer (BXG) and apply it as sorbents to remove Cu<sup>2+</sup>, Zn<sup>2+</sup>, Cr<sup>2+</sup> and Cd<sup>2+</sup> ions from aquatic solution; (2) to investigate

the influence of sorbent dosage and contact time on the removal efficiency of heavy metals from aquatic solution.

## EXPERIMENT

Chemical composition of low grade bauxite from the Paklarica deposit in Montenegro which is used to prepare BXG sample is given in the table 1.

Table 1: Chemical composition of low grade bauxite

Content, %									
SiO <sub>2</sub>	Al <sub>2</sub> O <sub>3</sub>	CaO	Fe <sub>2</sub> O <sub>3</sub>	MgO	MnO	Na <sub>2</sub> O	K <sub>2</sub> O	TiO <sub>2</sub>	Cr <sub>2</sub> O <sub>3</sub>
15.00	54.00	0.45	13.00	0.15	0.10	0.20	0.10	2.00	0.09

Geopolymers were prepared by the mixing of low grade bauxite with alkali activator which was prepared by the mixing of Na<sub>2</sub>SiO<sub>3</sub> and 10 M NaOH solutions in a mass ratio of 1.5. Sodium silicate solution (Na<sub>2</sub>O = 8.5%, SiO<sub>2</sub> = 28.5%, density of 1.4 kg/m<sup>3</sup>) was a commercial water glass supplied by Galenika Magmasil, Belgrade, Serbia, and sodium hydroxide solution was obtained by dissolving of solid NaOH pallets (99.5% purity) in deionized water.

The sample of BXG was prepared at solid to liquid ratio of 2.5. The fresh geopolymeric paste was casted in a plastic cylinder mould and cured for a period of 72 h (24 h in closed mould, the next 24 h in an open mould) at the temperature of 65 oC. After this time the sample was, removed from mould and left to cure additional 24 h. The hardened BXG sample was left to stay at ambient conditions for a period of 4 weeks before it have been used for adsorption tests. After that, the BXG sample were crashed and sized – reduced down to the size between 200 and 160 μm. The powdered BXG powder were washed to remove the excess sodium hydroxide, and then used for adsorption tests.

The study of simultaneous removal of heavy metals (Cu<sup>2+</sup>, Zn<sup>2+</sup>, Cr<sup>2+</sup> and Cd<sup>2+</sup>) from aquatic solution using BXG was carried out using batch equilibrium technique according to the following procedure; 1000 ml of solutions (initial concentration of Cu<sup>2+</sup>, Zn<sup>2+</sup>, Cr<sup>2+</sup> and Cd<sup>2+</sup> +was 100 ppm) was added to a fixed mass of BXG (0.4, 0.6, 0.8, 1, and 1.2 g/l) at pH value of 5 at room temperature. The mixture was shaken at constant temperature for a fixed period of time. The slurry was extracted at regular intervals and filtered. The filtrates were analyzed for the concentrations of heavy metals by inductively coupled plasma emission spectroscopy (ICP-OES).

Removal efficiency RE (%) was calculated using the following equation:

$$RE = \frac{C_0 - C}{C_0} \cdot 100 \quad (1)$$

where Co is the initial concentration of heavy metals (mg/l) and C is the residual concentration of heavy metals ion in solution after the certain time.

## RESULTS AND DISCUSSION

The effect of BXG dosage on the removal efficiency of heavy metals from aquatic solution is given in the Fig. 1. The removal efficiency of Cu<sup>2+</sup> and Cr<sup>2+</sup> ions increases from 9.05 to 26.5 % and 3.8 to 27.7 %, respectively with the increase of sorbent dosage from 0.4 to 0.6 g/l. Further increase of sorbent dosage up to 1.2 g/l does not influence the removal efficiency of these ions considerably. On the other hand, the maximal removal efficiency for Zn<sup>2+</sup> and Cd<sup>2+</sup> ions was achieved at the sorbent dosage of 0.8 g/l while further increase of sorbent dosage lead to the decrease of removal efficiency.

Thus, the sorbent dosage of 0.8 g/l was chosen as an optimal for the investigation of influence of contact time on removal of heavy metals from aquatic solution.

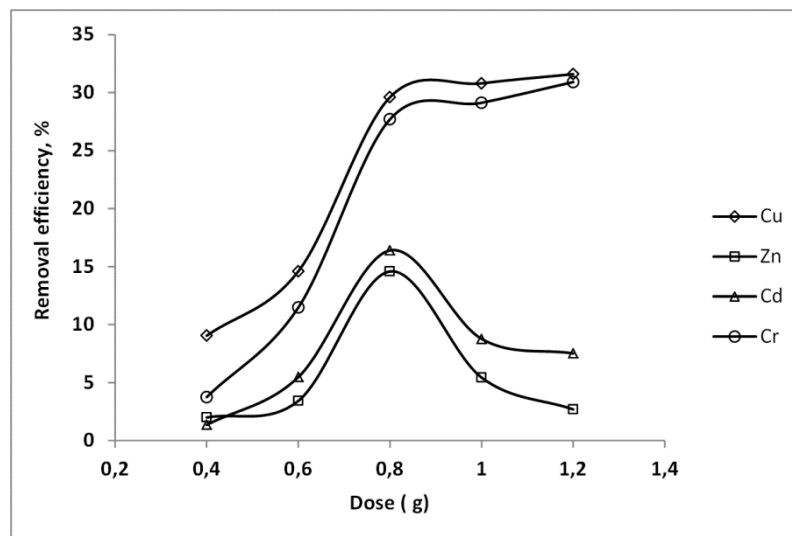

Figure 1. Effect of adsorbent dosage on heavy metals removal from aquatic solution (100 ppm concentration, 25°C, pH = 5.0, and contact time = 90 min)

The influence of contact time on the adsorption of heavy metals from aquatic solution was investigated in the range of 5 and 90 min at the constant concentration of heavy metals (initial concentration of  $\text{Cu}^{2+}$ ,  $\text{Zn}^{2+}$ ,  $\text{Cr}^{2+}$  and  $\text{Cd}^{2+}$  were 100 ppm) and adsorbent dose (0.8 g/l) at 25 °C and pH of 5. The results are given in the Fig. 2. It is evident that removal efficiency of heavy metals increase with the increase of contact time. The increase of removal efficiency of heavy metals from aquatic solution was observed up to 30 min and thereafter it remain almost constant. This indicate that adsorption equilibrium for  $\text{Cu}^{2+}$ ,  $\text{Zn}^{2+}$ ,  $\text{Cr}^{2+}$  and  $\text{Cd}^{2+}$  on the BXG was reached in the 30 min. This could be due to the strong attractive forces between heavy metal ions and the sorbent (Zhao at al. 2011). At this equilibrium time, the uptake percentage of heavy metals on the BXG was 27.7; 24.6; 10.77 and 12.3 % respectively.

Moreover, it is evident the removal efficiency (after 90 min) for  $\text{Cu}^{2+}$  and  $\text{Cr}^{2+}$  (27.8 and 26.5 % respectively) is much higher in comparison to the  $\text{Zn}^{2+}$  and  $\text{Cd}^{2+}$  ions (11.6 and 13.4 % respectively). These results indicate the higher sorption affinity of BXG to  $\text{Cu}^{2+}$  and  $\text{Cr}^{2+}$  in comparison to the  $\text{Zn}^{2+}$  and  $\text{Cd}^{2+}$  ions.

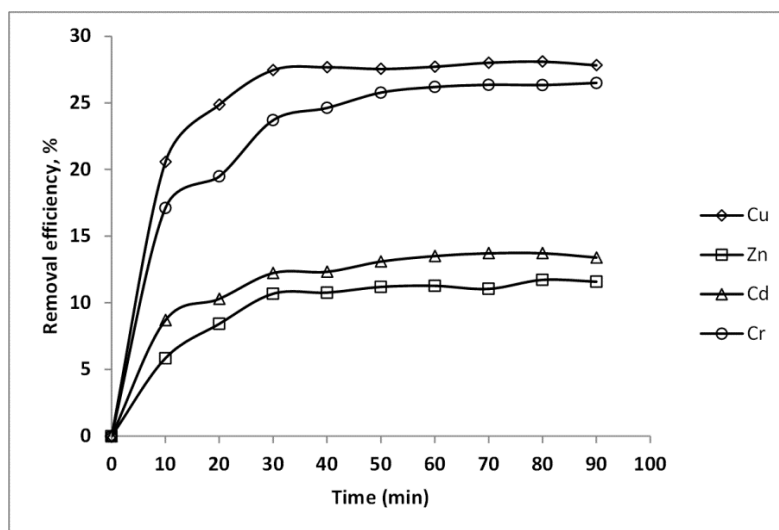

Figure 2. Effect of contact time on heavy metals removal from aquatic solution (100 ppm concentration, 25°C, pH = 5.0, and adsorbent dose 0.8 g/l)

## CONCLUSIONS

This study assessed the uptake of  $\text{Cu}^{2+}$ ,  $\text{Zn}^{2+}$ ,  $\text{Cr}^{2+}$  and  $\text{Cd}^{2+}$  from aqueous solutions onto the novel BXG adsorbent. Influence of adsorbent dosage and contact time on the removal efficiency of heavy metals from aquatic solution was investigated. The results have shown that removal efficiency of these ions from aquatic solution depending on the sorbent dosage and contact time. The highest removal efficiency was reached with sorbent dosage of 0.8 g/l and equilibrium was achieved after 30 min of adsorption process. Moreover, the higher affinity of BXG adsorbent was observed for  $\text{Cu}^{2+}$  and  $\text{Cr}^{2+}$  in comparison to the  $\text{Zn}^{2+}$  and  $\text{Cd}^{2+}$  ions.

## REFERENCES

- Ali, R.M., Hamad, H.A., Hussein, M.M., Malash, G.F. (2016). Potential of using green adsorbent of heavy metal removal from aqueous solutions: Adsorption kinetics, isotherm, thermodynamic, mechanism and economic analysis, *Ecological Engineering* 91, 317–332.
- Al-Zboon, K., Al-Harabsheh, M.S., Hani, F.B. (2011) Fly ash-based geopolymer for Pb removal from aqueous solution, *Journal of Hazardous Materials* 188, 414–421.
- Bailey, S., Olin, T., Bricka, R.M., Adrian, D.D., (1999). A review of potentially low-cost sorbents for heavy metals. *Water Research* 33, 2469–2479.
- Bolan, N., Kunhikrishnan, A., Thangarajana, R., Kumpiene, J., J., Makino, T., Kirkham, M.B., Scheckel, K. (2014). Remediation of heavy metal(loid) s contaminated soils—to mobilize or to immobilize? *Journal of Hazardous Materials* 266, 141–166.
- Chuah, T.G., Jumariah, A., Azni, I., Katayon, S., Thomas Choong, S.Y. (2005). Rice husk as a potentially low-cost biosorbent for heavy metal and dye removal: an overview, *Desalination* 175, 305–316A.
- Deng, X., Lu, L., Li, H., Luo, F. (2010). The adsorption properties of Pb(II) and Cd(II) on functionalized graphene prepared by electrolysis method, *Journal of Hazardous Materials* 183, 923–930.
- Ge, Y., Yuan, Y., Wang, K., He, Y., Cui, X. (2015) Preparation of geopolymer-based inorganic membrane for removing  $\text{Ni}^{2+}$  from wastewater, *Journal of Hazardous Materials* 299, 711–718.
- Heechan, C. Dalyoung, O., Kwanho, K. (2005). A study on removal characteristics of heavy metals from aqueous solution by fly ash, *Journal of Hazardous Materials* B127, 187–195.
- Mohan, S., Gandhimathi R. (2009) Removal of heavy metal ions from municipal solid waste leachate using coal fly ash as an adsorbent, *Journal of Hazardous Materials* 169, 351–359.
- Ünlü, N., Ersoz, M. (2006). Adsorption characteristics of heavy metal ions onto a low cost biopolymeric sorbent from aqueous solutions, *Journal of Hazardous Materials* 136, 272–280.
- Wang, X., Lu, J., Xing, B. (2008). Sorption of organic contaminants by carbon nanotubes: influence of adsorbed organic matter, *Environmental Science and Technology*, 42, 3207–3212.
- Zhao, G., Li, J., Ren, X., Chen, C., Wang, X. (2011). Few-layered graphene oxide nanosheets as superior sorbents for heavy metal ion pollution management, *Environmental Science and Technology* 45 10454–10462.

V International Conference  
„ECOLOGY OF URBAN AREAS“ 2016

## MEASUREMENT OF FREE CHLORINE IN SWIMMING POOL WATER BY FIBER OPTIC SENSOR

**Boris Obrovski<sup>1</sup>, Ivana Mihajlović<sup>1</sup>, Jovan Bajić<sup>2</sup>, Mirjana Vojinović Miloradov<sup>1</sup>,  
Dragan Adamović<sup>1</sup>, Branislav Batinić<sup>2</sup>, Miloš Živanov<sup>2</sup>**

<sup>1</sup>University Of Novi Sad, Faculty Of Technical Sciences, Department Of Environmental Engineering, Trg  
Dositeja Obradovića 6, 21000 Novi Sad, Serbia

<sup>2</sup>University Of Novi Sad, Faculty Of Technical Sciences, Department of Power, Electronic and  
Telecommunication Engineerin, Trg Dositeja Obradovića 6, 21000 Novi Sad, Serbia

borisobrovski@uns.ac.rs\*, ivanamihajlovic@uns.ac.rs, Bajić@uns.ac.rs, miloradov@uns.ac.rs,  
draganadamovic@uns.ac.rs, banebb@uns.ac.rs, zivanov@uns.ac.rs

### ABSTRACT

*Residual chlorine is important physico-chemical parameter which should be monitored in the swimming pools. Public pools are used for recreation and chlorine compounds used for water disinfection may lead to a number of unwanted effects. Therefore, it is necessary to examine the chlorine quality status of swimming pool water. Fiber optic sensor (FOS) is an innovative method for monitoring of residual chlorine in different water bodies. FOS represents the color sensor. Based on the color intensity of the sample, FOS determines the concentration of the examined parameters. Device converts RGB (Red-Green-Blue) color model to HSV (Hue-Saturation-Value) color model. Based on S and V parameters FOS measures concentration. H parameter was used for the calculation of wavelength at which applied sensor measures the concentration of residual chlorine. The results obtained with the FOS were compared with results obtained with a standard analytical method (UV-Vis spectrophotometer) to demonstrate the efficacy of the implemented device. The results prove the use of FOS as a laboratory “low-cost” device for measurement of residual chlorine in swimming pool water as a substitute for expensive standard equipment. For the first time FOS original method was used for measuring free chlorine in swimming pool water.*

**Key words:** *Fiber optic sensor, chlorine, swimming pool, monitoring.*

### INTRODUCTION

Chlorine is used for disinfection of drinking water and swimming pool water which are used for recreation and human activities. In Serbia, the free chlorine is used to disinfection of swimming pool water and concentration of free chlorine are according to regulation recommendations on water safety of a drinking water (Gazette SRJ 42/98 and 44/99). In the process of disinfection carcinogenic and toxic organic compounds could be generated, which could negatively effect on human health. In swimming pools, concentrations of residual chlorine are routinely monitored in order to determine the effectiveness of the disinfection process. Excessive use of disinfecting agents leads to the emergence of hazardous compounds dangerous to human health.

Standard analytical methods are used for determination of swimming pool water quality. It is known that standard analytical methods have certain disadvantages due to the complexity of chemical analysis, the high price of adequate analytical equipment, sensitive sample preparation and other complex operations. These limits require new and cost-effective methods for monitoring of water body. Enabling FOS for the measurement of chemical pollutants in the swimming pool would permit fast, simple and reliable monitoring of the studied water bodies and timely response in case of contamination.

One of the main advantages of the FOS in comparison with traditional methods is the possibility of providing spatial and temporal information on the characteristics of the selected water system, which permits long-term assessment of seasonal variations and the sustainability of the environment [1,2].

The advantages of FOS compared to the conventional methods are: simple use, low-cost device, small dimensions (which enables measurements where other devices do not have access), resistant to electromagnetic influences and corrosion, enabling measurements in inaccessible and remote areas, possibility to use in high aggressive chemical environments, electric power is not required at sampling points, etc., [3,4,5]. The unique advantage of fiber optic sensors is the ability to connect various sensors via wireless network. Wireless network enables monitoring of a large number of physico-chemical parameters of the aquatic medium. Length of optical fiber to the several kilometers enables monitoring of examined parameters in the expanded field of observation.

Mentioned advantages allow the use of FOS in the industry, biomedical, civil engineering (construction of dams and buildings), pharmaceutical and many other applications. FOS are used for examination of surface water, groundwater, ocean water, industrial and municipal wastewater, landfill leachate, wastewater from agricultural run-off, acid rain, etc., [6]. Earlier the high price of components for construction of devices, expensive field research and a long period of time to implement the FOS, prevented the development of field devices that could be used in real environments. Intensive development in this field and decrease in the price of the construction components for device led to the production of field devices and many studies are still in progress.

FOS was calibrated to measure physico-chemical parameters in different aquatic media. FOS was designed and calibrated for measuring of nitrite [7,8], temperature and potassium ions [9]. Multiparameter device for measurement of ammonia, nitrite and chromium [10], probe for measurement of organic pollutants [11], cyanide, phosphate, sulfate, nitrate and nitrite [6] and heavy metal cations  $\text{Co}^{2+}$ ,  $\text{Cu}^{2+}$ ,  $\text{Ni}^{2+}$ ,  $\text{Fe}^{3+}$ ,  $\text{Cd}^{2+}$ ,  $\text{Zn}^{2+}$ ,  $\text{Pb}^{2+}$  and  $\text{Hg}^{2+}$  [12] were developed. FOS applied in this research is designed and calibrated to measure orthophosphate, sulfate, nitrite, total chlorine and hexavalent chromium ( $\text{Cr}^{+6}$ ) in surface water [13].

The aim of this study is to enable calibration of FOS for measurement of residual chlorine in water from the swimming pool. The results obtained by applied sensor were compared with the results obtained by standard laboratory methods (UV-Vis) to confirm the effectiveness of the FOS device. Measurements were carried out to confirmed reliability, accuracy and reproducibility of results obtained with the FOS. Results confirm the possibility of using the FOS in laboratory controlled conditions as “low-cost” solution and as replacement for expensive standard laboratory equipment.

## **MATERIALS AND METHODS**

Samples for laboratory analysis were collected from swimming pool in the city of Novi Sad, Serbia. Samples are poured into 1 L glass bottles, stored in hand refrigerator at 4 °C, and transported to the laboratory. Analyses were carried out in accredited Laboratory for monitoring of landfills, wastewater and air, Department of Environmental Engineering and Occupational Safety and Health in Novi Sad.

Concentrations of free chlorine in water samples were analyzed according to the HACH Method (HACH Method 8021). The concentrations of free chlorine were measured with UV-VIS spectrophotometer (DR 5000, HACH, Germany).

Operating principle of implemented FOS is the absorption of light (Figure 1). When the light passes through a liquid, certain wavelengths will be transmitted while others are absorbed depending on the color of the tested liquid. Fiber optic sensor detects the color intensity of sample and converts RGB color model in HSV color model. The used sensor determines V and S value and calculates concentration of the parameters of interest, and H value which is used for calculation of wavelength.

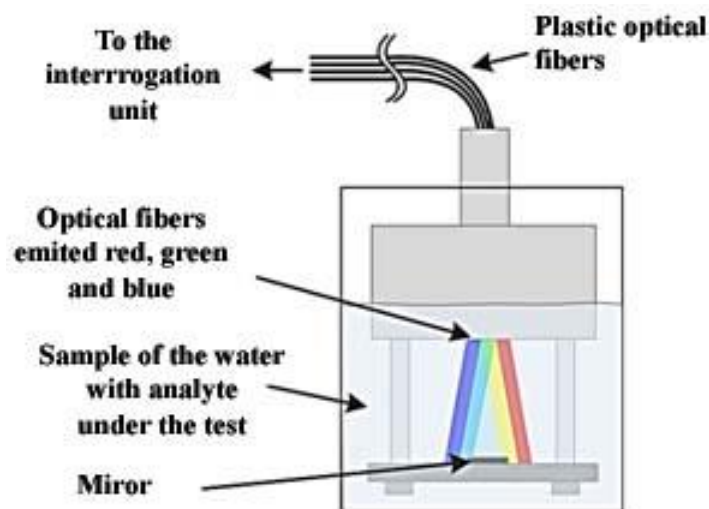

Figure 1. Principle of operation for FOS

The sensor consists of three plastic optical fibres (POFs) that emit red, green and blue components mounted around a central optical fibre collecting light reflected from the mirror. The mirror is located on the underside of the sensor where the optical fiber is compiled. Three light-emitting diodes red, green and blue are set to different frequencies. In this way detection of the reflected signal is achieved with only one photodetector and three bandpass filters.

## RESULTS AND DISCUSSION

Residual chlorine was measured in public closed swimming pool in the city of Novi Sad by original FOS for the first time. To examine the efficacy and applicability of the applied sensor, results obtained by the standard analytical method (UV-Vis spectrophotometer) were compared with results by FOS.

The sensor is calibrated with 5 different standard solutions prepared by diluting a standard solution for residual chlorine. Reference sample with the lowest concentration of residual chlorine have bright pink color and with increasing concentrations of residual chlorine, the color of the sample becomes more intense.

FOS converts RGB color model to HSV color model and determine selected parameter based on color intensity of the sample. Residual chlorine concentrations were calculated and determined on the basis of the parameter S, based on calibration curves obtained with the referent sample. The V value for residual chlorine is constant and it is not possible to determine concentrations based on V values with the applied sensor. In Table 1 relative differences for residual chlorine between standard laboratory method (UV-Vis spectrophotometer) and implemented sensor (FOS) were presented. The concentrations of residual chlorine were relatively low approximately in the range 0,1 to 0,2 mg/l in samples from swimming pool water which is in correspondence with the recommendations on water safety of a drinking water (Gazette SRJ 42/98 and 44/99).

Table 1. Relative difference between concentrations obtained with UV-Vis spectrophotometer and FOS for water from swimming pool.

Measurement	UV-Vis [mg/l]	FOS [mg/l]	Relative difference [%]
1	0,09	0,104	<b>15,56</b>
2	0,19	0,203	<b>6,84</b>

Relative differences for observed parameter measured by FOS are higher for low concentrations (Figure 2). Samples of swimming pool water were spiked with known concentrations of residual



chlorine (Table 2). The results for the spiked sample confirmed the possibility of using FOS for measurements in the laboratory conditions.

Table 2. Relative difference between concentrations obtained with UV-Vis spectrophotometer and FOS for spiked sample of water from swimming pool.

Measurement	UV-Vis [mg/l]	FOS [mg/l]	Relative difference [%]
1	0,65	0,66	<b>1,54</b>
2	0,94	1,03	<b>9,57</b>

H parameter is used for calculation of the wavelength at which the FOS measures the concentration of the parameter of interest. H parameter is constant for residual chlorine. Based on equation (1) wavelength was determined.

$$\lambda [nm] = -1.1 * H[^\circ] + 700 \quad (1)$$

Where:  $\lambda$  is wavelength and H is hue.

Wavelength at which FOS measure residual chlorine is 527 nm, and for UV-Vis spectrophotometer wavelength of 530 nm is used. Comparison with two methods has relative difference 0.56 %, and high correspondence.

Obtained and processed results show the possibility of using FOS in laboratory controlled conditions. Small changes in FOS construction will improve efficiency and accuracy of devices and could replace standard expensive equipment.

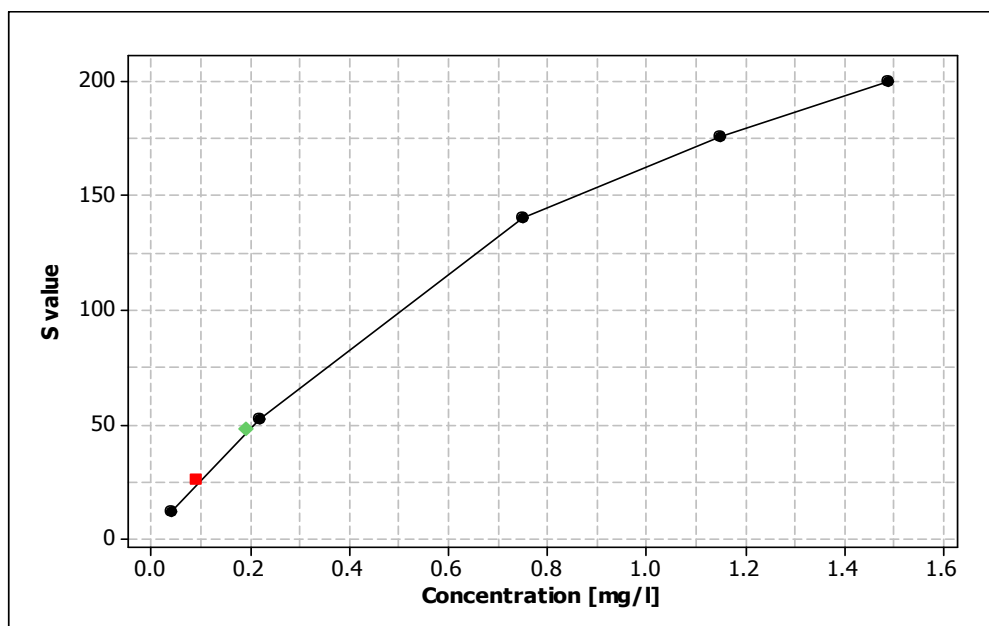

Figure 2. Concentration for residual chlorine measured with FOS based on S value

Future research should be focused on improving the performance and characteristics of the FOS. Selection of quality LED and components for construction of device will ensure more accurate and more reliable results for monitored environmental media. FOS showed certain deviations with lower concentrations. Increasing the sensitivity of the device would remove the limiting factor. Wastewater currently cannot be monitored with the FOS because of coloration, turbidity, unwanted reactions and contamination of the examined sample. Removing the color without loss analyte of interest will allow the use of FOS for wastewater.

## CONCLUSION

FOS instrument device applicable for measuring of residual chlorine. At this moment, FOS is capable for monitoring of the surface water quality and swimming pool water. In water samples from the swimming pool the concentration of free chlorine was successfully measured. The concentration of free chlorine is in the range of 0.1 to 0.2 mg/l which is in accordance to recommend regulations on water safety of a drinking water (Gazette SRJ 42/98 and 44/99). FOS represents multiparameter device that is capable of measuring six parameters: orthophosphate, residual chlorine, nitrite, sulfate, total chlorine and hexavalent chromium (Cr (VI)). Expanding range of examined parameters would allow the use of FOS for wide range of applications. FOS is a laboratory prototype and basis for construction of field device. The field fiber optic color sensor will provide *in-situ* and real-time information about the current state of the selected water bodies. This type of examination is conducted for the first time in Serbia with the original FOS method for detection of free chlorine in the swimming pool.

## ACKNOWLEDGMENT

The authors acknowledge for the funding provided by the Ministry of Education, Science and Technological Development of Republic of Serbia under project ‘Development of methods, sensors and systems for monitoring quality of water, air and soil’, number III43008.

## LITERATURE

- [1] Kersey, A.D.: *A Review of Recent Developments in Fiber Optic Sensor Technology*, Optical fiber technology, 2, 291-317, 1996.
- [2] Grattan, K.T.V., Sun, T.: *Fiber optic sensor technology: an overview*, Sensors and Actuators, 82, 40-61, 2000.
- [3] Klainer, S., Thomas, R., Francis, J.: *Fiber-optic chemical sensors offer a realistic solution to environmental monitoring needs*, Sensors and Actuators, 11, 81-86, 1993.
- [4] Ghong, S.S., Abdul Aziz, A. R., Harun, S.W.: *Fibre Optic Sensors for Selected Wastewater Characteristics*, Sensors, 13, 8640-8668, 2013.
- [5] Ahmad, A.B.H.: *Development of a portable optical fibre chemical sensor measuring instrument*, Department of Instrumentation and Analytical Science, UMIST, Manchester, 1994.
- [6] S. M. Klainer, J. R. Thomas, J. C. Francis: *Fiber-optic chemical sensors offer a realistic solution to environmental monitoring needs*, Sensors and Actuators B, 11, 1993, 81-86.
- [7] P.S. Kumar, C.P.G. Vallabhan, V.P.N: Nampoori, V.N.S. Pillai, P. Radhakrishnan: *A fibre optic evanescent wave sensor used for detection of trace nitrites in water*, Journal of Optics: Pure and applied optics, 4, 2002, 247-250.
- [8] N.A. Aljaber, B.R. Mhdi, S.K. Ahmmad, J.F. Hamode, M.M. Azzawi, A.H. Kalad, S.M. Ali: *Design and Construction Fiber sensor detection system for water nitrite pollution*, Journal of Engineering, 04, 2014, 37-43.
- [9] A. Dybko, W. Wroblewski, E. Rozniecka, K. Pozniakb, J. Maciejewski, R. Romaniuk, Z. Brzozka: *Assessment of water quality based on multiparameter fiber optic probe*, Sensors and Actuators B, 51, 1998, 208-213.
- [10] P.S. Kumar: *Design and development of fiber optic sensors for trace detection of certain environmental pollutants*, Ph D Thesis, 2003.
- [11] H. Steiner, M. Jakusch, M. Kraft, M. Karlowatz, B. Mizaikoff, T. Baumann, R. Niessner, W. Konz, A. Brandenburg, K. Michel, C. Boussard-Pledel, B. Bureau, J. Lucas, Y. Reichlin, A. Katzir, N. Fleischmann, K. Staubmann, R. Allabashi, J. M. Bayona: *In Situ Sensing of Volatile Organic Compounds in Groundwater: First Field Tests of a Mid-Infrared Fiber-Optic Sensing System*, Society for Applied Spectroscopy, 57, 2003, 124-130.
- [12] N. Malcik, O. Oktar, M. E. Ozser, P. Caglar, L. Bushby, A. Vaughan, B. Kuswandi, R. Narayanaswamy: *Immobilised reagents for optical heavy metal ions sensing*, Sensors and Actuators B, 53, 1998, 211-221.
- [13] Obrovski B., Bajić J., Mihajlović I., Vojinović-Miloradov M., Batinić B., Živanov M.: *Colorimetric fiber optic probe for measurement of chemical parameters in surface water*, Sensors and Actuators B: Chemical, 2016, Vol. 228, pp. 168-173.

V International Conference  
„ECOLOGY OF URBAN AREAS“ 2016

**EFFICIENCY OF ZNO/SNO<sub>2</sub> NANO POWDER CATALYST FOR  
PHOTODEGRADATION OF PHARMACEUTICALLY ACTIVE  
WATER POLLUTANTS**

**Mladenka Novaković<sup>1\*</sup>, Veselin Bežanović<sup>1</sup>, Tamara Ivetić<sup>2</sup>, Ivana Mihajlović<sup>1</sup>, Goran Štrbac<sup>2</sup>, Dragana Štrbac<sup>1</sup>, Maja Đogo<sup>1</sup>**

<sup>1</sup>University of Novi Sad, Faculty of Technical Sciences, Department of Environmental Engineering, Trg Dositeja Obradovića 6, 21000, Novi Sad, Serbia

<sup>2</sup>University of Novi Sad, Faculty of Science, Department of Physics, Trg Dositeja Obradovića 4, 21000, Novi Sad, Serbia

mladenkanovakovic@uns.ac.rs, veselinbezanovic@uns.ac.rs, tamara.ivetic@df.uns.ac.rs,  
ivanamihajlovic@uns.ac.rs, grstrbac@uns.ac.rs, draganastrbac@uns.ac.rs, majadjogo@uns.ac.rs

**ABSTRACT**

*In this paper, we study the application possibilities of semiconductor metal oxide photocatalysis, an alternative method for the wastewater purification, when ZnO/SnO<sub>2</sub> catalyst was used. ZnO/SnO<sub>2</sub> mixed powder photocatalyst was prepared using a simple, inexpensive, eco-friendly mechanochemical processing in order to assure coupling of the valence and conduction bands of individual oxides and slow down the recombination rate of electron/hole pairs, the generated charged carriers that actuate the formation of the reactive oxygen species which are responsible for further chain reactions that lead to the complete degradation of the organic contaminant. Carbamazepine (CBZ, 5H-dibenzo[b,f]azepine-5-carboxamide), an antiepileptic drug, is one of the most frequently detected pharmaceutical residue in wastewater effluents. Once introduced in sewage system, elimination of CBZ by conventional wastewater treatment plant is not efficient (less than 10%). This fact can be explained due its persistence and water soluble nature. During its forceful chemical stability, carbamazepine can be qualified as an ideal marker of environmental water contamination. The kinetics of the carbamazepine photodegradation in the presence of the obtained mixed catalyst and under UV irradiation was monitored using the HPLC technique. The presented preliminary results have shown that degradation of CBZ after 25 minutes was approximately 80%.*

**Key words:** photocatalysis, pharmaceuticals, wastewater.

**INTRODUCTION**

In last decade, occurrence of trace organic pollutants, such as pharmaceuticals in different water media, has become an important subject of scientific community. Due its high production consumption and their pharmacokinetic behavior, the presence of the active pharmaceutical compounds (PhACs) in natural water is unavoidable (Lopez Fernandez et al., 2014). Pharmaceuticals present biological compounds which are designed with high stability for their main effect on humans and they are metabolized in human body by biochemical processes. They can be converted either completely or partly to water soluble metabolites, but sometimes they remain in unchanged form (Teixeira et al., 2016). One of most unique property of the emerging pollutants is that they are found in trace amounts (microgram to nanogram per liter) in the aquatic receiver of the effluents (eg. surface water). Due their continuous infiltration into aquatic media via sewage systems, pharmaceutical micropollutant become persistent contaminants although they have short half life.

There are different sources of pharmaceutical residues: pharmaceutical industries, inappropriate disposal of expired medicines on landfills causing their presence in landfill leachate and groundwater. The main gateway of these classes of micropollutants in environment is wastewater treatment plant (WWTP). Conventional treatment plants are inefficient for its removal. The variations in the pharmaceutical removal efficiencies are present because of various factors such as differences in physical and chemical properties (hydrophobicity and biodegradability), seasonal conditions and design of WWTP. Many studies show that application of traditional biological treatment for reduction

or elimination of PhACs is inappropriate due the fact that most of pharmaceuticals are poorly biodegradable (Luo et al., 2014).

Carbamazepine (CBZ,  $C_{15}H_{12}N_2O$ ) belongs to a group of anticonvulsant drugs and it is one of most frequently detected pharmaceutical residue in water bodies (Mohaptra et al, 2014a). This neutral, antiepileptic drug has a long history of clinic usage. CBZ (5H-dibenzo[b,f]azepine-5-carboxamide) is designed to control certain types of seizures in patients with epilepsy (Martinez et al., 2011). After oral use, 72% of CBZ is adsorbed, while 25% remains unchanged and discharged through feces and 2-3% via urine. According to previous studies, the elimination of CBZ is poor in municipal wastewater treatment plant (less than 10%). Recent studies have shown that sludge retention time (SRT) process after 275 days is not sufficient for its removal. CBZ is present in aquatic environment at several hundred nanograms per liter in surface water. This is confirmed by its high ubiquity in the environment at concentration levels of several hundred nanograms per liter in different surface waters (Petrovic et al, 2009). According to value of the octanol–water partitioning coefficient ( $\log K_{ow}$ ) and the distribution coefficient ( $K_d$ ) between water and secondary sludge, 2.45 and 1.2  $L\ kg^{-1}\ SS$ , carbamazepine shows no significant tendency to sorb onto sludge (Zhang et al., 2008). Because of its recalcitrant nature, carbamazepine was chosen as an ideal anthropogenic marker of water pollution. Figure 1. shows structure of carbamazepine.

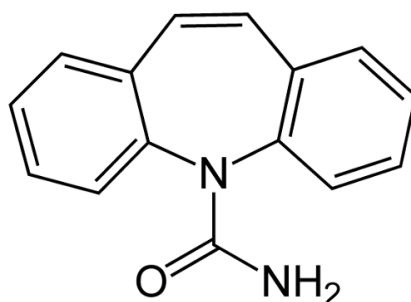

Figure 1. Structure of CBZ

Advanced oxidation processes (AOPs) have a great potential for oxidation and destruction of a wide range of organic pollutants (Mohaptra et al., 2014b). Different kind of AOPs includes heterogeneous photocatalysis based on UV or solar irradiation, electrolysis, ozonation, Fenton process and many other. In recent years, heterogeneous photocatalysis has been widely investigated since it has a great potential in environmental water remediation.

The aim of this work is to investigate the possibility of photocatalytic degradation of antiepileptic carbamazepine with a mixture of zinc oxide-tin oxide ( $ZnO/SnO_2$ ). Zinc oxide and tin oxide are characterized with good photostability and photoactivity when they are together applied on photocatalytic degradation of organic micropollutants. Figure 2. shows degradation mechanism with applied combination of these two photocatalysis. According to previous studies, under UV illumination, electrons are excited from valence band (VB) to the conduction band (CB) of the both oxides forming holes ( $h^+$ ). The created holes react with hydroxyl groups or physisorbed water molecules and then the free radicals are formed. The electrons on surface of tin oxide react with dissolved oxygen molecules which with water create more free radicals (Ivetić et al., 2014).

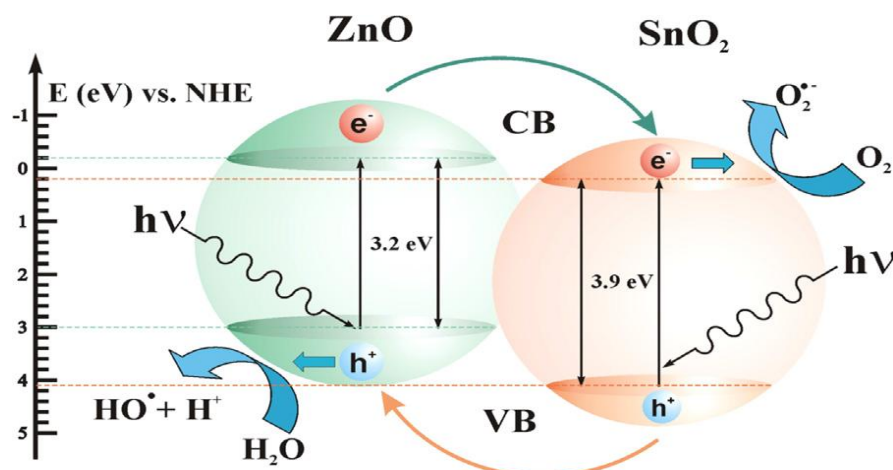

Figure 2. The mechanism of photodegradation with ZnO/SnO<sub>2</sub> combination (Ivetić et al., 2014.)

## MATERIALS AND METHODS

### Preparation of semiconductor system ZnO/SnO

ZnO/SnO<sub>2</sub> nanoparticles powder mixture was prepared by a simple solid-state method, where starting precursors (ZnO and SnO<sub>2</sub>, Sigma Aldrich, purity 99.9% and particle size  $\leq 1$   $\mu\text{m}$ ) were ground in an agat mortar in molar ratio 2:1, annealed at 700°C in air for two hours and ground again (Ivetić et al., 2016).

### Chemicals and reagents

CBZ powder (solubility in water 17.7  $\text{mgL}^{-1}$ ) was commercially available from Sigma Aldrich. Acetonitrile and concentrated formic acid were in analytical grade without previous purifications (Sigma Aldrich).

### Preparation of standard solution

The stock solution of analyzed pharmaceutical was prepared by dissolving 5 mg of standard in 25 ml of acetonitrile (200  $\text{mgL}^{-1}$ ). As the aqueous model, distilled water was used.

### Photocatalytic experiment

The photocatalytic decomposition of CBZ was carried out at room temperature (ca. 293 K) in aqueous solution upon UV illumination in batch mode. The initial concentration of carbamazepine was 6  $\text{mgL}^{-1}$ . In order to investigate the change in composition of investigated pollutant, different time interval (5, 10, 20, 30, 40, 50 and 70 minutes) of stirring was applied. Source of UV light was a 125 W high-pressure mercury lamp (Philips, HPL-N, emission bands in the UV region at 304, 314, 335, and 366 nm, with maximum emission at 366 nm). The aqueous solutions, volume of 50 ml, with 20 mg of catalyst were exposed under continuous UV irradiation. Samples were stirred at magnetic agitator with a 130 rpm speed. Each sample was filtrated through filter paper (diameter 90 mm) in order to separate ZnO/SnO<sub>2</sub> nanoparticles. After filtration step, 1 ml of sample was transferred into 2 ml vials.

### Analytical method

HPLC (high performance liquid chromatograph) with diode array detector (Agilent 1260 series) was used for determination of CBZ concentration after photocatalytic degradation. Chromatography separation was performed at reverse, stationary phase Eclipse XDB-C18 (150 x 4.6, particle size 5  $\mu\text{m}$ ) at flow rate of 0.2  $\text{ml min}^{-1}$  and injection volume of 10  $\mu\text{L}$  at room temperature. Mobile phases were

consisted of: A – 0.1 formic acid and B – acetonitrile and gradient elution mode was as follows: 3 min, 20% of B%, 15 min, 45% of B, 25 min, 45% of B, 27 min, for 30% of B, in 30 minute initial conditions. The maximum absorbance for observed pharmaceutical is 290 nm.

## RESULTS AND DISCUSSION

After HPLC analysis, HPLC offline program was used for calculation of final concentrations. The concentrations were calculated according to the surface area under the peak of analyte. The linear calibration curve was constructed in range 1.5 – 10 mg L<sup>-1</sup> with good correlation coefficient  $r^2 = 0.999$ . Removal efficacy was calculated by following equation (1):

$$R(\%) = \frac{c_0 - c_e}{c_0} \times 100 \quad (1)$$

Where:

$c_0$  (mgL<sup>-1</sup>) – initial concentration of target pollutants,  $c_e$  (mgL<sup>-1</sup>) – final concentration after heterogeneous catalysis. Obtained results are shown at Table 1.

Table 1. The results of photocatalytic degradation of carbamazepine

Time of irradiation (min)	Area (mAU)	Final concentration (mgL <sup>-1</sup> )	Removal efficacy (%)
0	1196.6	6.00	0.0
5	284	1.46	75.6
10	280	1.43	76.1
20	276.2	1.42	76.3
30	250.3	1.28	78.5
40	208.8	1.07	82.1
50	208.7	1.07	82.1
70	196.9	1.01	83.1

Retention time of carbamazepine was  $t_R = 21.4$  min. Results show that photocatalysis with ZnO/SnO<sub>2</sub> is progressive after 5 minutes of UV exposure. The area under the peak was slowly decreased on illumination time and the initial concentration of 6 mgL<sup>-1</sup> (Peak Area= 1196.6 mAU) was minimized to 1.46 mgL<sup>-1</sup> (Peak Area=284 mAU after 5 minutes). The maximum degradation rate (83.1%) was reached after 70 minutes of UV exposure. The increase in removal efficacy by the time was shown at Figure 3 (Line is to guide the eye).

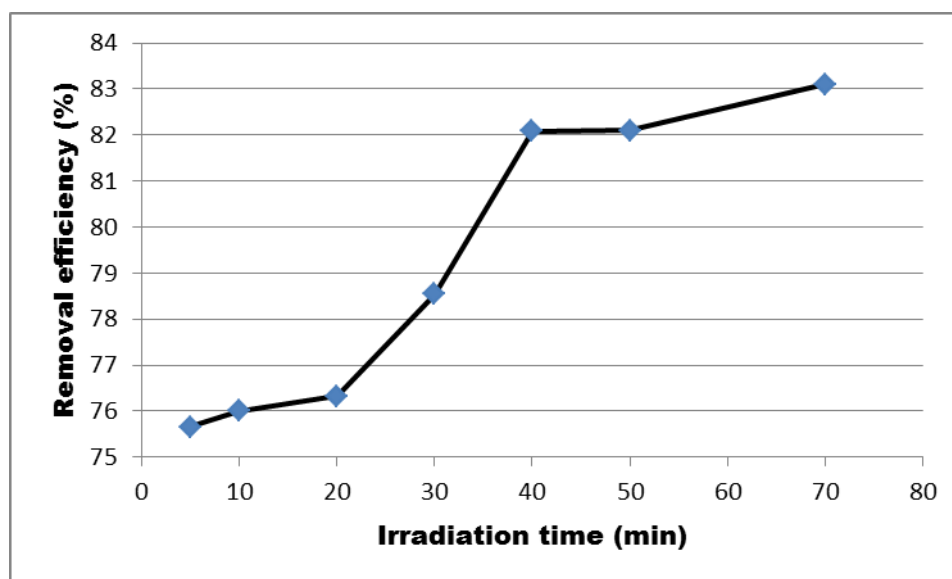

Figure 3. Removal efficacy of carbamazepine by ZnO/SnO<sub>2</sub> nanopowder on irradiation time

## CONSLUSION

Ecofriendly mixed ZnO/SnO<sub>2</sub> nanopowder (ZnO and SnO<sub>2</sub>) was used for photocatalytic degradation of antidepressant- carbamazepine. The results show that degradation of 83.1% carbamazepine was achieved after 70 minutes with 20 mg of ZnO/SnO<sub>2</sub> under UV irradiation. Photocatalytic mineralization with application of new semiconductor ZnO/SnO<sub>2</sub> may be seen as a promising a state-of-the-art wastewater treatment technology for the removal different kinds of pollutants, such as pharmaceuticals.

For further studies, it is essential to optimize operating conditions (concentration of catalyst, time of irradiation, initial concentration of investigated pollutant, effect of pH value, water matrices) and to identify byproducts formed during reaction and proposed degradation pathways.

## REFERENCES

- Ivetić, T. B., Dimitrievska, M. R., Finčur, N.L., Đačanin, Lj. R., Gúth, I. O., Abramović, B. F., & Lukić-Petrović, S. R. (2014). Effect of annealing temperature on structural and optical properties of Mg-doped ZnO nanoparticles and their photocatalytic efficiency in alprazolam degradation. *Ceramics International*, 40(1), 1545-1552.
- Ivetić, T. B., Finčur, N. L., Abramović, B. F., Dimitrievska, M., Štrbac, G. R., Čajko, K. O., Miljević, B. B., Đačanin, Lj. R., & Lukić-Petrović, S. R. (2016). Environmentally friendly photoactive heterojunction zinc tin oxide nanoparticles. *Ceramics International*, Vol 42, 3575-3583.
- López Fernández, R., McDonald, J. A., Khan, S. J., & Le-Clech, P. (2014). Removal of pharmaceuticals and endocrine disrupting chemicals by a submerged membrane photocatalysis reactor (MPR). *Separation and Purification Technology*, Vol 127, 131-139.
- Luo, Y., Guo, W., Ngo, H. H., Nghiem, L. D., Zhang, H. J., Liang, S., & Wang, X. C. (2014). A review on the occurrence of micropollutants in the aquatic environment and their fate and removal during wastewater treatment. *Science of the Total Environment*, Vol 473-474, 619-641.
- Martínez, C., Canle L. M., Fernández, M. I., Santaballa, J. A., & Faria, J. (2011). Kinetics and mechanism of aqueous degradation of carbamazepine by heterogeneous photocatalysis using nanocrystalline TiO<sub>2</sub>, ZnO and multi-walled carbon nanotubes–anatase composites. *Applied Catalysis B: Environmental*, Vol 102, 563-571.
- Mohapatra, D. P., Brar, S. K., Dagher, R., Tyagi R. D., Picard, P., Surampalli, R. Y., & Drogui, P. (2014b). Photocatalytic degradation of carbamazepine in wastewater by using a new class of whey-stabilized nanocrystalline TiO<sub>2</sub> and ZnO. *Science of the Total Environment*, Vol 485-486, 263-269.
- Mohapatra, D. P., Brar, S. K., Tyagi, R. D., Picard, P., & Surampalli, R. Y. (2014a). Analysis and advanced oxidation treatment of a persistent pharmaceutical compound in wastewater and wastewater sludge-carbamazepine. *Science of the Total Environment*, Vol 470-471, 58-75.
- Petrovic, M., De Alda, M. J., Diaz-Cruz, S., Postigo, C., Radjenovic, J., Gros M., & Barcelo, D. (2009). Fate and removal of pharmaceuticals and illicit drugs in conventional and membrane bioreactor wastewater treatment plants and by riverbank filtration. *Philosophical Transaction of the Royal Society A*, 367, 3979 - 4003.
- Teixeiraa, S., Gurkeb, R., Eckerta, H., Kuhn, K., Faulerb, J., & Cunibert, G. (2016). Photocatalytic degradation of pharmaceuticals present in conventional treated wastewater by nanoparticle suspensions. *Journal of Environmental Chemical Engineering*, 4(1), 287-292.
- Zhang, Y., Geißen, S. W., & Gal, C. (2008). Carbamazepine and diclofenac: Removal in wastewater treatment plants and occurrence in water bodies. *Chemosphere*, Vol 72, 1151-1161.

V International Conference  
„ECOLOGY OF URBAN AREAS“ 2016

**KINETIC AND EQUILIBRIUM STUDIES OF  $Cd^{2+}$  ADSORPTION  
ONTO LOW-COST ADSORBENT PREPARED FROM PLUM KERNELS**

**Sabolc Pap<sup>1</sup>, Nikola Boskovic<sup>1</sup>, Jelena Radonic<sup>1</sup>, Dragan Adamovic<sup>1</sup>, Maja Sremacki<sup>1</sup>,  
Olivera Paunovic<sup>1</sup>, Maja Turk Sekulic<sup>1</sup>**

<sup>1</sup>Department of Environmental Engineering, Faculty of Technical Sciences, University of Novi Sad, Serbia  
boskovicnikola16@gmail.com

**ABSTRACT**

*Activated carbon is the most widely used adsorbent in wastewater treatment owing to its high specific surface area and high degree of surface reactivity. The aim of this study was to make low-cost activated carbon derived from plum (*Prunus domestica* L.) kernels by thermo-chemical activation using phosphorous acid. Kinetics and equilibrium of cadmium removal from aqueous solutions by sorption onto synthesized activated carbon have been investigated using batch adsorption experiments. Time dependent assays show rapid adsorption in first twenty minutes and optimal adsorption in first thirty minutes. Four kinetic models were used in this study to describe the adsorption process. The data fitted very well ( $R^2=0.999$ ) to a pseudo-second-order kinetic model, suggesting that the adsorption is a chemisorption process. Using plum kernel activated carbon in batch mode, the effects of initial  $Cd^{2+}$  concentration (5-500 mg/L) was studied. The best result was obtained at pH 6, with an adsorbent dosage of 100 mg,  $Cd^{2+}$  concentration of 50 mg/L and a contact time of 30 min, with over 93% of the  $Cd^{2+}$  being adsorbed. The adsorption behavior was well described by the Langmuir isotherm model, showing a maximum adsorption capacity of 112.74 mg/g. Current study show that alternative low-cost activated carbons prepared from fruit kernels can be used as low-cost adsorbent for the removal of  $Cd^{2+}$  from aqueous solution.*

**Key words:** plum kernels, activated carbon, adsorption kinetic and equilibrium, green technology.

**INTRODUCTION**

The increasing use of heavy metals over the past few decades has inevitably led to an increased flux of metallic substances in ground and surface water, as well as in drinking water, and posed serious ecological and health risks. Cadmium (Cd) is considered to be an extremely toxic metal without all known biological functions. Contamination of drinking water may occur as a result of the presence of  $Cd^{2+}$  in fittings, water heaters, water coolers and taps (Wang et al., 2010).

Heavy metal toxicity can result in damaging or reducing mental and central nervous function, lowering energy levels and damaging blood composition, lungs, kidneys, liver and other vital organs (Amarasinghe and Williams, 2007). Cd tends to accumulate in human body, especially in kidneys, thus leading to their dysfunction (Wang et al., 2010). Presence of metals in water streams and marine water causes a significant health threat to aquatic community and most common being is damaging of fish gills. Consequently, in many countries, more strict legislation has been introduced to control water pollution. Thus, Cd has been included in the red list of priority pollutants by the Department of Environment, UK, and in the black list of Dangerous Substance Directive in European Economic Community. US Environment Protection Agency has also classified Cd in group B1 carcinogen. The permissible limit for Cd in drinking water in China, as well as the drinking water guideline value recommended by World Health Organization, is 0.005 mg/L. It is of great importance for water purification to develop efficient procedures for the removal of Cd from aquatic environments (Wang et al., 2009). Removal of metal ions from wastewater in an effective manner has become an important issue today (Amarasinghe and Williams, 2007).

Among numerous clean-up techniques for water treatment, adsorption techniques are widely used for the removal of diverse contaminants. Commercial activated carbon is a preferred adsorbent used to remove impurities from liquid solutions; however, its widespread use is restricted due to the high cost. As such, alternative non-conventional low-cost adsorbents have been studied and natural, industrial as



well as synthetic materials have been tested for the removal of heavy metals from water (Wang et al, 2010).

Production of activated carbons is based mainly on the natural organic substrates, hard coal, brown coal, wood, sawdust, local waste products. Many cheap, easily available agricultural and/or plants-based materials such as silk cotton hull, sago industry waste, banana pith, maize cob (Kadirvelu et al, 2003), jute fiber (Senthilkumaar et al., 2005), palm kernel shell (Jumasiah et al., 2005), rice bran (Sankar et al., 1999), rice husk (Guo et al., 2003), mango seed kernel powder (Kumar and Kumaran, 2005), plum kernels (Wu et al., 1999) and apricot stone shells (Khalil and Girgis, 1998), have been used as a source for the production of activated carbon aimed for the removal of heavy metals. Plum kernels are a cheap precursor for activated carbon source. Therefore, it is important to evaluate its performance as adsorbent. The advantages of the adsorption reside in the simplicity of operation, low cost compared to other separation methods, no sludge production and its efficiency (Bhattacharyya and Gupta, 2008; Pap et al., 2014).

This study was conducted to test adsorption ability of plum kernels activated carbon for the removal of cadmium from artificial aqueous solutions. Operating parameters such as initial  $\text{Cd}^{2+}$  concentration, adsorbent dosage, kinetics and equilibrium varied during the experiments in order to study their influence on the adsorption process.

## **THEORY**

Activated carbons are high surface area (ranging from 600-2000  $\text{m}^2/\text{g}$ ) materials prepared from various amorphous carbon materials (Bhatnagar and Minocha, 2006). The methods for production of activated carbon can be divided into two categories: physical and chemical activation. The physical activation method involves carbonization of a precursor at elevated temperatures (500–900 °C) in an inert atmosphere, followed by activation of the resulting char at high temperatures (800–1000 °C) in the presence of a  $\text{CO}_2$  or steam atmosphere. In the chemical activation method, raw material is impregnated with an activating reagent and the impregnated material is heated under an inert atmosphere. The carbonization step and the activation step progress simultaneously in the chemical activation method. Different well-known chemical agents can be used in the chemical activation process and phosphoric acid and zinc chloride are the most commonly used as activation reagents. The common feature of all substances used in the chemical activation process is that they are dehydrating agents which influence pyrolytic decomposition and inhibit the formation of tar, thus enhancing the yield of activated carbon (Soleimani and Kaghazchi, 2007). Chemical activation method has many advantages such as: lower temperature for pyrolysis, whole process is performed in one step, produces a much higher yield than physical activation, can obtain very high surface area of activated carbons, microporosity can be well developed, controlled and maintained in a narrow range and reduction of mineral matter content.

Adsorption on activated carbon is a well-known process for removing various organic contaminants and organic carbon in general. It is most commonly applied as a powdered feed or in a granular form in packed bed filters (Snyder et al., 2007). Activated carbon used in wastewater treatment is generally prepared from coconut shells, peat, sawdust, wood char, lignin, petroleum coke, bone char, anthracite coal etc. Nowadays, many third world countries are faced with the economic problems of producing active carbons in high yield and Serbia is one of them. However, Serbia has great amount of organic waste, which can be processed and used efficiently. Plum is well known plant which is used among population mostly as food and brewing ingredient. Tons of plum kernels are thrown away in the process. In this paper, the possible usage of plum kernels as effective ingredient for active carbon production is studied.

## **METHODS**

Standard solution of cadmium (J.T. Baker – 1000 mg/l) is used in all experiments. Plum kernels obtained from Vojvodina region (Serbia) are air dried, crushed and screened to obtain two fractions

with geometrical mean sizes ranging from 1,6 mm to 3,1 mm. 30 g of the selected fraction (< 1,6 mm) are impregnated with H<sub>3</sub>PO<sub>4</sub> solution (50%) in mass ratio of 2,66:1. After mixing, solutions were allowed to stand at room temperature for 24 h and then filtered and dried at 90°C for 24h. After this period, impregnated samples were ready for the carbonization and activation which were carried out simultaneously. Impregnated samples are activated in a hot air oven at 500°C (2 h). The carbonized material is washed with distilled water to remove the free acid until the pH of the activated carbon reached about 7 and dried at 105°C. The clean adsorbent is mechanically ground and sifted to get a powder of different particle sizes (Pap et al., 2015).

The effects of the experimental parameters such as, the initial Cd<sup>2+</sup> concentration (30-120 mg/L), pH (about 6), adsorbent dosage (100 mg), and temperature (25°C) on the removal of Cd<sup>2+</sup> ions is studied in a batch mode for a specific period of contact time (5–100 min). The different concentrations of solution are prepared by dilution in distilled water. For the kinetic studies, 100 mg of low cost adsorbent is contacted with 50 ml of Cd<sup>2+</sup> solutions in Erlenmeyer flasks. The flasks are then placed on a rotary shaker at 120 rpm. The Cd<sup>2+</sup> content in the supernatant is measured using flame atomic absorption spectrometry (FAAS, model Thermo Scientific S2 AA System) (Pap et al., 2016).

Two important equations are used to calculate amount of adsorbed Cd<sup>2+</sup> by activated carbon  $q_t$  (mg/g) (1) and to determine percent of removal of heavy metal from solution (2):

$$q_t = \frac{[(C_0 - C_t) * V]}{m} \quad (1)$$

$$Removal (\%) = \frac{(C_0 - C_t)}{C_0} * 100 \quad (2)$$

for (1)  $C_0$  is the initial Cd<sup>2+</sup> concentration and  $C_t$  is the Cd<sup>2+</sup> concentration (mg/l) at any time,  $V$  is the volume of solution (l) and  $m$  is the mass of activated carbon (g), but for (2)  $C_0$  is the initial and  $C_t$  is the equilibrium concentration (mg/l) of Cd<sup>2+</sup>.

Kinetics was investigated with pseudo first- and pseudo second-order kinetic models. Lagergren proposed integral form of pseudo first-order kinetic model is given by equation (3):

$$\ln(q_e - q_t) = \ln q_e - K_1 t \quad (3)$$

where  $q_t$  is the adsorbed amount (mg/g) at time  $t$  (min),  $q_e$  is the amount adsorbed (mg/g) at equilibrium, and  $K_1$  is the equilibrium rate constant of pseudo-first-order adsorption (1/min). The straight line of the plot of  $\ln(q_e - q_t)$  versus time suggest the applicability of the Lagergren equation for the present system. The values of  $K_1$  were determined from the slope of the plot (Figure 1) (Pap et al., 2014). Pseudo second-order kinetic model (4) is reported to follow most of the sorption systems:

$$\frac{t}{q_t} = \frac{1}{K_2 q_e^2} + \frac{1}{q_e} t \quad (4)$$

where  $K_2$  is the pseudo-second-order rate constant of adsorption. The plots of  $t/q_t$  versus  $t$  (Figure 2) were used to determine the rate constants and correlation coefficients.

Calculated correlation coefficients for both kinetic models show and explain which mechanism is predominant - physisorption or chemisorption.

In order to successfully represent the equilibrium-adsorption behavior, it is important to have a satisfactory description of the state between the two phases constituting the adsorption system. Two kinds of several isotherms equations were tested to fit the experimental data: Langmuir (5) and Freundlich (6) isotherms equations were tested to fit the experimental data (Pap et al., 2015):

$$\text{Langmuir isotherm: } \frac{C_e}{q_e} = \frac{1}{q_{max} b} + \frac{C_e}{q_{max}} \quad (5)$$

$$\text{Freundlich isotherm: } \log q_e = \log K_F + \frac{1}{n} \log C_e \quad (6)$$

where  $q_e$  is the amount adsorbed at equilibrium (mg/g) and  $C_e$  is the equilibrium concentration of metal ions in solution (mg/L). Linear regression of the experimental data determines other parameters such as isotherm constants. In the Langmuir equation,  $q_{max}$  (mg/g) represents the maximal adsorption capacity under the experimental conditions and  $b$  is a constant related to the energy of adsorption. In the Freundlich equation,  $n$  indicate of bond energies between metal ion and the adsorbent and  $K_F$  relates to bond strength. In kinetic and equilibrium assays, comparable plots are evaluated firstly by the values of  $R^2$ .

## FINDINGS

Laboratory assays gave experimental data which were sufficient for statistical analysis of kinetic models, such as pseudo first- (Figure 1) and pseudo second-order kinetic model (Figure 2). Rate constants and correlation coefficients are shown in Table 1.

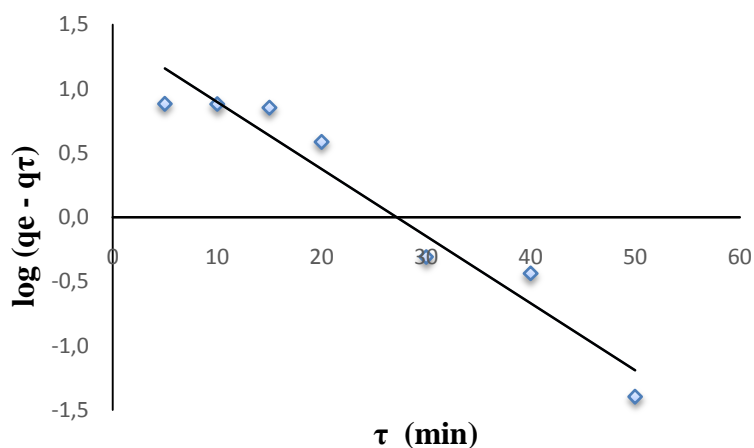

Figure 1. Pseudo first-order kinetic model for adsorption of Cd (II) ions on plum charcoal

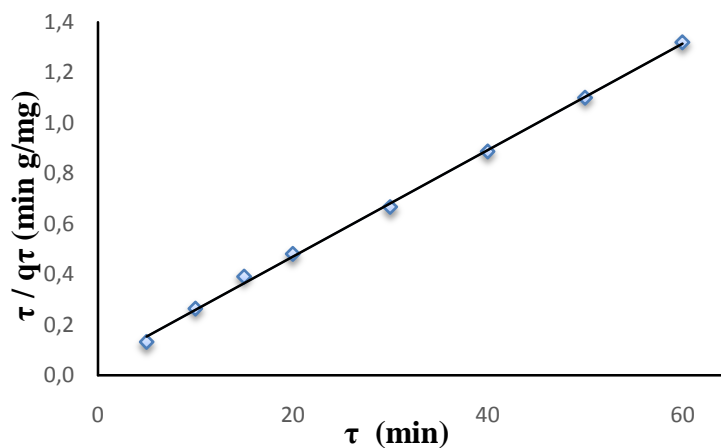

Figure 2. Pseudo second-order kinetic model for adsorption of Cd (II) ions on plum charcoal

Table 1: Rate constants and correlation coefficients

Kinetic model	Parameters	Values
Pseudo-first-order model	$K_1$ (g/mg min)	-0,1202
	$R^2$	0,9383
	$q_{e,cal}$ (mg/g)	26,23
Pseudo-second-order model	$K_2$ (g/mg min)	0,0092
	$R^2$	0,9987
	$q_{e,cal}$ (mg/g)	47,40

Initial Cd (II) concentration ( $C_0$ ) was 100 mg/l and  $q_{e,exp}$  was 45,47 mg/g. The difference between  $q_{e,exp}$  and  $q_{e,cal}$  obtained testing the first-order model indicates that the adsorption of Cd (II) ions onto plum charcoal does not follow first-order kinetics. The  $q_{e,cal}$  using the pseudo-second-order model is in good agreement with the experimental  $q_{e,exp}$  values.

Simple removal efficiency of  $Cd^{2+}$  ions on activated carbon shows that 30 min is sufficient for optimal removal (Figure 3).

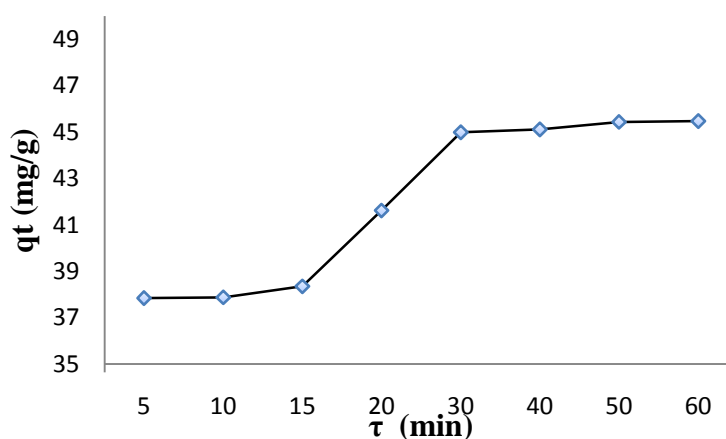

Figure 3. Removal efficiency of  $Cd^{2+}$  ions on activated carbon

Obtained from the experimental data, Langmuir (Figure 4) and Freundlich (Figure 5) isotherm constants are given in Table 2.

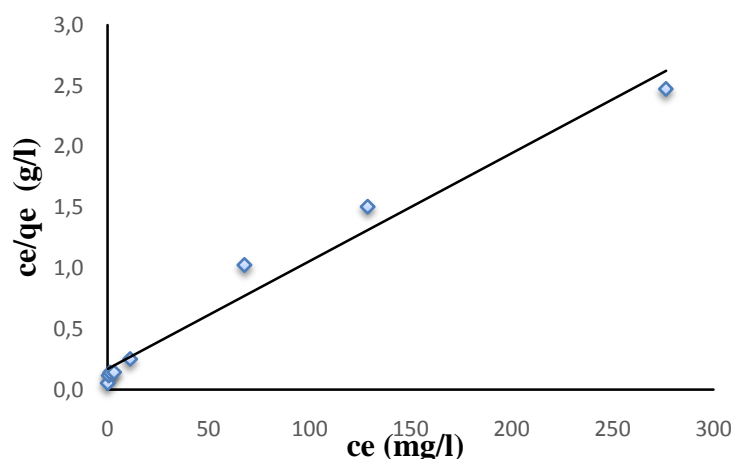

Figure 4. Langmuir adsorption isotherm of Cd (II) ions on plum charcoal

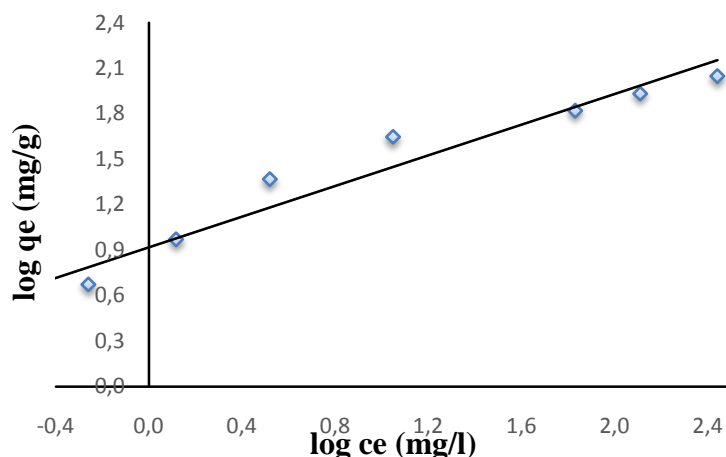

Figure 5. Freundlich adsorption isotherm of Cd (II) ions on plum charcoal

Table 2: Langmuir and Freundlich constants

Metals	Langmuir constants			Freundlich constants		
	$q_{\max,cal}$	$b$	$R^2$	$K$	$1/n$	$R^2$
$Cd^{2+}$	112,74	0,0520	0,9734	8,2933	0,5054	0,9593

Figures 4 and 5 indicate that the adsorption of Cd (II) ions could well be fitted by the both, Langmuir and Freundlich model. Initial concentrations ( $C_0$ ) were 5-500 mg/l and  $q_{\max,exp}$  was 111,78 mg/g. As shown in Figure 6, increasing metal ion concentrations in solutions resulted in increasing adsorbed metal ion concentrations, but decreasing removal efficiency.

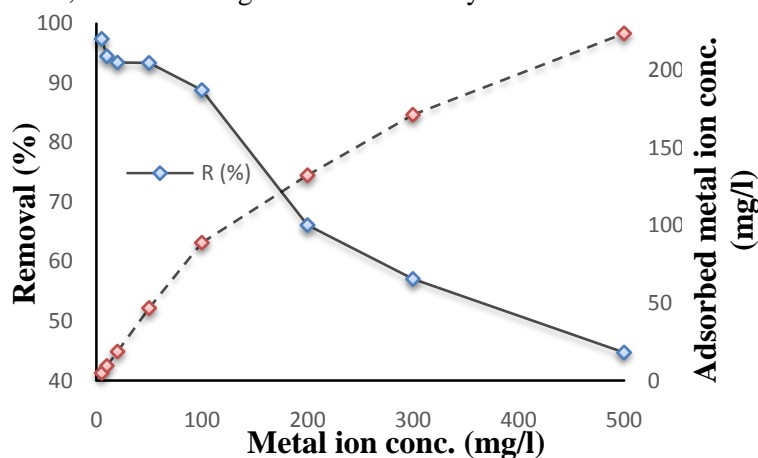

Figure 6. Removal efficiency versus adsorbed metal concentration

## DISCUSSION

Although pseudo-first-order kinetic model shows good value of correlation coefficient ( $R^2 = 0,9383$ ), pseudo-second-order kinetic model gives even better correlation coefficient value ( $R^2 = 0,9987$ ), which indicate that adsorption kinetics fit pseudo-second-order kinetic model for applied activated carbon. These results suggest that chemisorption might be the rate-limiting step that controls the adsorption process, because pseudo-second-order kinetic model is predominant.

Comparison of coefficients indicates that the Langmuir isotherm fits our experimental data more precisely ( $R^2 = 0,9734$ ) than the Freundlich isotherm ( $R^2 = 0,9593$ ). The basic assumption of Langmuir adsorption is based on adsorbate monolayer coverage of the surface of adsorbent, which

points toward that the adsorption of Cd (II) ions onto plum kernel charcoal generates monolayer formation.

With increasing Cd (II) ion concentration in solutions, the removal efficiency on activated carbon decreases, showing predominance of chemisorption at lower and physisorption at higher concentrations.

## CONCLUSIONS

The conducted study has shown that activated carbon prepared from plum kernels can be effectively used as low cost adsorbent for the removal of Cd<sup>2+</sup> from aqueous solution. The Langmuir model provides a better fit of the equilibrium adsorption data compared with the Freundlich model. Calculated maximum adsorption capacity, using the Langmuir model, is 112,74 mg/g. We assumed that chemisorption is the rate-limiting step because adsorption of Cd<sup>2+</sup> onto adsorbent follows the pseudo-second-order kinetic model. The assumption that the removal efficiency decreases with increasing concentration of adsorbate on the adsorbent is confirmed by experimental data.

## IMPLICATIONS

Further study should be done in order to investigate if plum kernels and other similar fruit waste can be used for water treatment on large scale conducting dynamic adsorption experiments and designing the pre-pilot and pilot scale process.

## ACKNOWLEDGMENT

This study has been financially supported by Ministry of Education, Science and Technological Development, Republic of Serbia (Project III46009).

## REFERENCES

- Amarasinghe, B.,M.,W.,P.,K., Williams, R., A. (2007). Tea waste as a low cost adsorbent for the removal of Cu and Pb from wastewater, *Chemical Engineering Journal* 132:299–309.
- Bhatnagar, A., Minocha, A., K. (2006). Conventional and non-conventional adsorbents for removal of pollutants from water – A review, *Indian Journal of Chemical Technology Vol. 13*, 203-217.
- Bhattacharyya, K., G., Gupta, S., S., (2008). *Adv. Colloid Interface Sci.* 140:114.
- Guo, Y., Yang, S., Fu, W., Qi, J., Li, R., Wang, Z., Xu, H. (2003). Adsorption of malachite green on micro- and mesoporous rice husk-based active carbon, *Dyes Pigments* 56:219–229.
- Jumasiah, A., Chuah, T., G., Gimbon, J., Choong T.,S.,Y., Azni, I. (2005). Adsorption of basic dye onto palm kernel shell activated carbon: sorption equilibrium and kinetics studies, *Desalination* 186:57–64.
- Kadirvelu, K., Kavipriya, M., Karthika, C., Radhika, M., Vennilamani, N., Pattabhi, S. (2003). Utilization of various agricultural wastes for activated carbon preparation and application for the removal of dyes and metal ions from aqueous solutions, *Bioresour. Technol.* 87:129–132.
- Khalil, L., B., Girgis, B., S. (1998) Column removal of some dyestuffs by activated carbons derived from apricot stone shells, *Adsorp. Sci. Technol.* 16:405–414.
- Kumar, K., V., Kumaran, A. (2005). Removal of methylene blue by mango seed kernel powder, *Biochem. Eng. J.* 27:83–93.
- Pap, S., Kolalović, S., Radonić, J., Mihajlović, I., Adamović, D., Vojinović-Miloradov, M., Turk Sekulić, M. (2016). Preparation and chemical characterization of low cost activated carbon produced from plum kernels, International Conference "State-of-the-art technologies: challenge for the research in Agricultural and Food Sciences", pp. 95, ISBN 978-86-7834-247-9
- Pap, S., Radonić, J., Adamović, D., Mihajlović, I., Vojinović-Miloradov, M., Nakomčić B., Turk Sekulić M. (2014). Kinetic and equilibrium studies of Pb<sup>2+</sup> adsorption on low-cost adsorbent prepared from plum and apricot kernels shell, Conference engineering of environment protection - TOP2014, Slovak university of technology in Bratislava, Bratislava, pp. 349-356, ISBN 978-80-227-4174-3
- Pap, S., Radonić, J., Brborić, M., Vojinović-Miloradov, M., Đukić, Z., Turk Sekulić, M. (2015). Activated carbons prepared from plum, apricot and cherry kernels. SETAC Europe Annual Meeting; Society of Environmental Toxicology and Chemistry, Barcelona, pp. 476.

- Pap, S., Radonić, J., Živančev, M., Adamović, D., Mihajlović, I., Vojinović-Miloradov, M., Turk Sekulić, M. (2014). Process development for the removal of heavy metal ion species from landfill leachate using plum kernels as a new adsorbent. The 15th European Meeting on Environmental Chemistry (EMEC15), Brno, Czech Republic, December ISBN: 978-80-214-5073-8, Publisher: Brno University of Technology, Editors: Josef Čáslavský, Renata Komendová, Helena Zlámalová Gargošová. Book of abstracts, pp. 73.
- Sankar, M., Sekaran, G., Sadulla, S., Ramasami, T. (1999). Removal of diazo and triphenylmethane dyes from aqueous solutions through an adsorption process, *J. Chem. Technol. Biotechnol.* 74:337–344.
- Senthilkumaar, S., Varadarajan, P., R., Porkodi, K., Subbhuraam, C., V., (2005). Adsorption of methylene blue onto jute fiber carbon: kinetics and equilibrium studies, *J. Colloid Interf. Sci.* 284:78–82.
- Snyder, S., A., Adham, S., Redding, A., M., Cannon, F., S., DeCarolis, J., Oppenheimer, J., Wert, E., C., Yoon, Y. (2007). Role of membranes and activated carbon in the removal of endocrine disruptors and pharmaceuticals, *Desalination* 202:156–181.
- Soleimani, M., Kaghazchi, T. (2007). Agricultural Waste Conversion to Activated Carbon by Chemical Activation with Phosphoric Acid, *Chem. Eng. Technol.*, No. 5, 649–654.
- Turk Sekulić, M., Pap, S., M. Brborić, M., Vojinović-Miloradov, M., Prica, M., Đukić, Z., Radonić, J. (2016). Activated carbons prepared from plum, apricot and cherry kernels: Influence of operational parameters and elemental composition on the maximum adsorption capacity of products, SETAC Europe Annual Meeting, pp. 257-258.
- Wang, F., Y., Wang, H., Ma, J., W. (2010). Adsorption of cadmium (II) ions from aqueous solution by a new low-cost adsorbent—Bamboo charcoal, *Journal of Hazardous Materials* 177:300–306.
- Wu, F., C., Tseng, R., L., Juang, R., S. (1999). Pore structure and adsorption performance of the activated carbons prepared from plum kernels, *J. Hazard. Mater.* 69:287–302.

V International Conference  
„ECOLOGY OF URBAN AREAS“ 2016

## SEPARATION OF PESTICIDE CARBENDAZIM FROM WATER BY ACTIVATED CARBON

Ali Hgeig<sup>1</sup>, Mladenka Novaković<sup>1\*</sup>, Mirjana Vojinović Miloradov<sup>1</sup>, Ivana Mihajlović<sup>1</sup>

<sup>1</sup>University of Novi Sad, Faculty of Technical Sciences, Department of Environmental Engineering,  
Trg Dositeja Obradovića 6, 21000 Novi Sad, Serbia

alihagaig@yahoo.com, mladenkanovakovic@uns.ac.rs, miloradov@uns.ac.rs, ivanamihajlovic@uns.ac.rs

### ABSTRACT

*Carbendazim has application in fungi inhibition, but it is also toxic and could be accumulated in water resources from agricultural runoff, manufacturing pesticide bottles and container washings. Therefore, it is very important to investigate the separation processes of carbendazim from water bodies. Adsorption with activated charcoal (powdered and granulated) proved to be an effective technique in the tertiary treatment of organic pollutants from aquatic systems. The aim of this paper was to determine the effectiveness of the removal of carbendazim using commercial types of activated carbons, Norit SA2 and Hydrodarco C. Influence of pH as well as mass of activated carbons were investigated. Determination of carbendazim concentrations was performed by HPLC. The results showed that the increase of the adsorbent mass caused the increase in removal efficiency of carbendazim, and at adsorbent mass of 10 mg removal efficiency has reached values of 95% for Norit SA2 and 87% for Hydrodarco C, respectively. pH influenced on removal of carbendazim from aqueous solutions. Highest removal efficiency was achieved in an alkaline medium.*

**Key words:** *fungicide, carbendazim, HPLC, aqueous solution.*

### INTRODUCTION

The use of herbicides in agriculture has increased over the past two decades, causing increase in surface and ground waters contamination and risks to human health. Pesticides have been detected in waste water, surface water and ground water (Singer et al., 2010; Schipper et al., 2008; Scribner et al., 2000). Contamination of waters by pesticides presents a serious environmental problem because of their potential toxicity and widespread use. Pesticides are included in different groundwater monitoring programs as a consequence of their detection in groundwater wells, demonstrating their capacity as leaches to groundwater and causing contamination in the hydrological systems. Main sources of contamination of agricultural areas are typical pesticide field applications or other agricultural practices, such as container and spray equipment rinsing or any other ones derived from agricultural industries, which may cause water pollution in a very large concentration range. In this situation, the protection of water resources requires effective pesticide degradation technologies that allow their removal in a fast and low-cost manner.

Main pathways of pesticides transport into the environment after their application were runoff, leaching, sorption, volatilization and crop removal. Many of these ways involve water transport, but could contribute to movement into new compartment. In many cases, multiple environmental fate processes interact and lead to variable byproduct formations as well as transport. Probably the single most important property influencing a pesticide's movement with water is its solubility. Soil is a complex mixture of solids, liquids and gases that provides the life support system for roots of growing plants and microorganisms such as bacteria. When a pesticide enters soil, it will stick to soil particles; particularly organic matter, through adsorption or dissolve and mix with the water between soil particles. As more water enters the soil through rain or irrigation, the adsorbed pesticide molecules may be detached from soil particles through desorption processes. The solubility of a pesticide and its sorption on soil are inversely related: increased solubility results in less sorption. Once pesticide reaches water resources by any transport way mentioned above, it poses a particular risk to the health of humans and animals.



Carbendazim (Methyl Benzimidazol-2-yl Carbamat) is among the most widely used pesticides for treating fungal diseases and unwanted herbs in crops, respectively. Carbendazim is broad-spectrum benzimidazole antifungal which can harm liver as well as the endocrine system and is suspected to have mutagenic and carcinogenic effects (Lim and Miller, 1997). Although the exact mechanism of action is unclear, carbendazim appears to binds to an unspecified site on tubulin and suppresses microtubule assembly dynamic. As a widely used fungicide, it has demanded research on developing sensitive and rapid analytical methods for monitoring it in soil, water samples, marketed fruits and vegetables (Singer et al., 2010).

Most of the wastewater treatment plants are not capable of removing effectively carbendazim and other pesticides. Therefore, there is a need to develop alternative processes to remove them from waters. Advanced oxidation processes have been proposed as alternative methods to ensure higher degradation and mineralization of pesticides present in waters. Adsorption on activated carbons is known to be one of the best methods to remove this type of hazardous compounds from polluted waters. Activated carbons are frequently used in granular and powder form to remove organic chemicals, such as pesticides, from water sources.

Thus, the aim of this study was to implement an effective technique to eliminate pesticides contaminant, carbendazim, from water. The removal of carbendazim from aqueous solutions was investigated under different initial conditions (pH, mass of adsorbent, contact time, initial concentration of carbendazim) using commercial activated carbons, Norit SA2 and Hydrodarco C.

## MATERIAL AND METHODS

Standard of carbendazim and HPLC grade acetonitrile were purchased from Sigma Aldrich. The standard solution was prepared by dissolving 5 mg of standard in 25 ml of acetonitrile.

The target pesticide was analyzed by High Performance Liquid Chromatography with Diode Array Detector (Agilent 1260 series). Separation was performed with a reversed phase column Eclipse XDB-C18 (3 x 150, particle size 3.5 $\mu$ m). The operating conditions were: flow of 0.4 mlmin<sup>-1</sup>, temperature of column was 30°C and injection volume of 10 $\mu$ L. The mobile phase consisted of water (A) and acetonitrile (B). The binary gradient elution started at 25%B in 1 minute, then linearly increased to 50%B in 5 minute, and at the end, initial condition were applied, 25%B in 7 minute. The maximum wavelength of 215 nm was used.

Adsorption studies were conducted by using batch adsorption experiments. Commercial activated carbons Norit SA2 and Hydrodarco C (manufacturer Acros Organics, Geel, Belgium) were used as adsorbents. Activated carbon Hydrodarco C is a powdered activated charcoal with mesh pore structure and 1-150  $\mu$ m particle size. It is obtained from lignite, after activation by water vapor. Activated carbon Norit SA2 is produced from peat rich in organic carbon.

The pH of the solutions was adjusted with HCl (0.1 M) or NH<sub>4</sub>OH (1 M). The effect of pH value on the adsorption efficiency of carbendazim was studied by using a 50 mL solution of 5.0 mgL<sup>-1</sup> of carbendazim contacted with 5.0 mg of adsorbent in the pH range of 2.0 to 10.0 at room temperature (22 °C $\pm$ 2 °C). Flasks were agitated on the shaker for 30 min. Experiment was performed by stirring speed of 140 rpm for 30 min. As aqueous matrix, distilled water was used. After stirring, experimental solutions were filtered. The percentage of carbendazim removal can be calculated using the following equation:

$$R(\%) = \frac{c_0 - c_e}{c_0} \times 100 \quad (1)$$

where:

$c_0$  (mgL<sup>-1</sup>) is initial concentration of pesticide, and  $c_e$  (mgL<sup>-1</sup>) is the equilibrium concentration of pesticide.

For the assessment of the mass of adsorbents on adsorption efficiency, 5.0 mgL<sup>-1</sup> of carbendazim solution were contacted with different masses of activated carbons (2, 5, 6, 8 and 10 mg) at optimum pH value for a contact time of 30 min at room temperature (22 ± 1 °C).

## RESULTS AND DISCUSSION

### Influence of pH value on carbendazim adsorption

Influence of pH on removal efficiency of carbendazim by adsorption on commercial activated carbons Norit SA2 and Hydrodarco C was presented in Fig. 1. Initial concentration of carbendazim was 5 ppm. Mass of adsorbent was 5 mg.

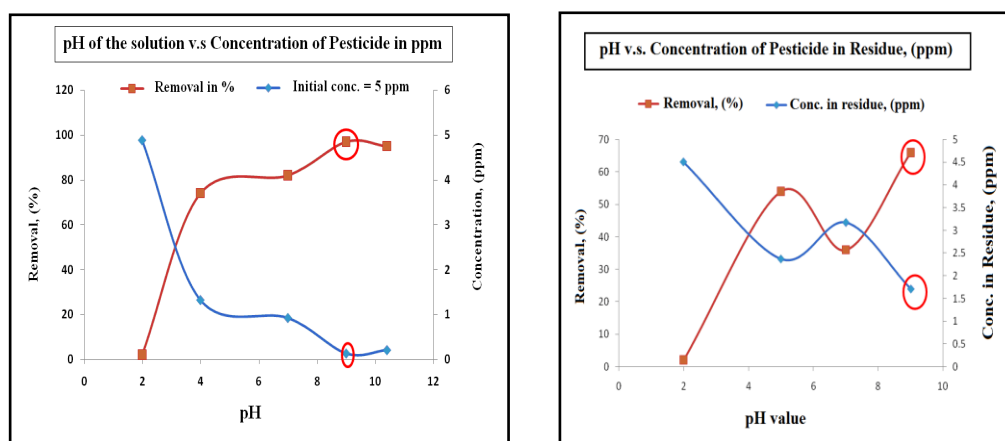

Figure 1. Effect of pH on removal efficiency of carbendazim by adsorption on a) Norit SA2 and b) Hydrodarco C

The results presented in Fig. 1 indicated that the maximum removal efficiency of carbendazim was 66% and 99% for commercial activated carbons, Norit SA 2 and Hydrodarco C, respectively. The adsorption was most favored in basic solution. Therefore, the further studies of carbendazim adsorption were performed at pH=9. During the adsorption process, the pH should be constant.

### Influence of mass of activated carbons on carbendazim adsorption

Adsorbent dosage is one of the most important parameters of adsorption. The effect of adsorbent concentration on the removal of carbendazim was shown in Fig. 2. Initial concentration of carbendazim was 5 ppm. The batch experiments were performed at optimal pH = 9. The removal of carbendazim is increased with increasing adsorbent concentration. The positive correlation between adsorbent dose and carbendazim removal can be related to an increase in the adsorbent surface area and availability of more adsorption sites. At dose of 10 mg, the removal efficiency (R%) achieved values of 95% and 87% for Norit SA 2 and Hydrodarco C, respectively.

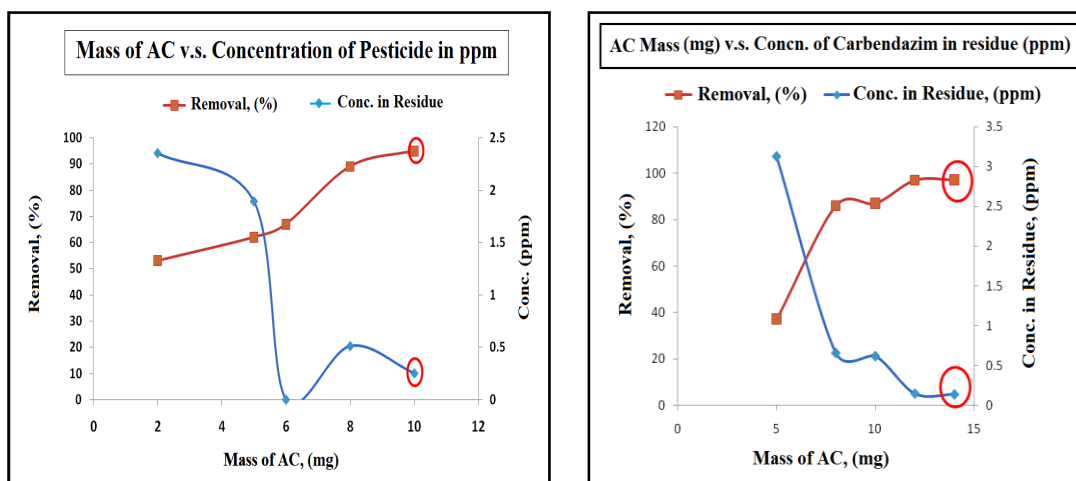

Figure 2. Effect of mass of adsorbent on removal efficiency of carbendazim by adsorption on a) Norit SA2 and b) Hydrodarco C

## CONCLUSIONS

The present study proved that both activated carbons (Norit SA2 and Hydrodarco C), commercially obtained and of powder type (high in surface area, in pore volume, and in external diameter), showed high efficiency in removal of pesticide carbendazim from aqueous solutions. Batch mode technique is very effective in carbendazim removal by both activated carbons. Carbendazim is used as a fungicide and its adsorption by both commercial activated carbons, Norit SA2 and Hydrodarco C, is dependent on the: type of adsorbent, pH of solution, and mass of the adsorbent. According to the obtained data, the removal of carbendazim was efficient by both activated carbons, Norit SA2 and Hydrodarco C and at optimal pH = 9 and 10 mg of adsorbent accounted to 95% and 87%, respectively.

## REFERENCES

- Lim, J., & Miller, M. G. (1997). The role of the benomyl metabolite carbendazim in benomyl-induced testicular toxicity. *Toxicology and Applied Pharmacology*, 142 (2), 401–410.
- Schipper, P. N. M., Vissers, M. J. M., & Van der Linden, A. M. (2008). Pesticides in groundwater and drinking water wells: overview of the situation in the Netherlands. *Water Science and Technology*, 57 (8), 1277–1286.
- Scribner, E. A., Thurman, E. M., & Zimmerman, L. R. (2000). Analysis of selected herbicide metabolites in surface and groundwater of the United States, *Science of Total Environment*, 248 (2-3), 157–167.
- Singer, H., Jaus, S., Hanke, I., Lueck, A., Hollender, J., & Alder, A. C. (2010) Determination of biocides and pesticides by on-line solid phase extraction coupled with mass spectrometry and their behavior in wastewater and surface waters. *Environmental Pollution*, 158 (10), 3054–3064.

V International Conference  
„ECOLOGY OF URBAN AREAS“ 2016

## COMPARISON OF EXPERIMENTAL AND THEORETICAL OXYGEN SATURATION, IN THE AERATION TREATMENT OF REFINERY WASTE WATER

Mirjana M. Ševaljević<sup>1</sup>, Milan Pavlović<sup>1</sup>, Stojan N. Simić<sup>2</sup>, Miroslav M. Stanojević<sup>3</sup>,  
Miladin V. Ševaljević<sup>4</sup>

<sup>1</sup>Technical Faculty “Mihajlo Pupin” in Zrenjanin, Đure Đakovića bb, 23000 Zrenjanin, University of Novi Sad, Serbia

<sup>2</sup>Oil Refinery, Modriča, Bosnia and Hercegovina

<sup>3</sup>Faculty of Mechanical Engineering University of Belgrade, Serbia

<sup>4</sup>“High Technical School in Zrenjanin“, Srbija  
sevaljevic.mirjana@gmail.com

### ABSTRACT

*This paper deals with the comparison of the measured oxygen saturation degree in the 15 examined aeration treatments of refinery wastewater with the same membrane diffuser and the different process parameters (c-h-q): added waste motor oil (c = 0 g·m<sup>-3</sup>, 5g·m<sup>-3</sup> and 10 g·m<sup>-3</sup>), water column height (h = 1m or 2) and air flow (q = 2 m<sup>3</sup>h<sup>-1</sup>, 6 m<sup>3</sup>h<sup>-1</sup> or 10 m<sup>3</sup>h<sup>-1</sup>). The diagnostic method is based on electrochemical equilibrium of dissolved gas oxygen and its gas pressure conservation law in period of hydrogen cathode stripping. The relative departure between calculated and measured values of oxygen saturation degree is to 2.8 % in the regime without added oil; 3 to 4.6 % in the regime with 5g·m<sup>-3</sup> added oil and 3 to 6.6. % in the regimes with 10g·m<sup>-3</sup> added oil to maximal 11.5 % for the regime 10-1-2.*

**Keywords:** Refinery wastewater, aeration, treatments, oxygen kinetic energy in electrochemical equilibrium, oxygen equilibrium gas pressure, oxygen stationary transport energy, hydrogen evolution over-potentials, concentrations of water vapor adsorbed in bubble surface.

### INTRODUCTION

Efficiency of aerobic biological processes in wastewater depend on oxygen introduction capacity i.e., of amount introduced by aeration system, per unit of electric power consumed electromotor, compressor, pumps etc. Actual oxygen introduction capacity has to be higher or equal to the actual oxygen consumption velocity. After saturation aeration period oxygen solubility degree defines the ratio between oxygen stationary content,  $c_s$  and oxygen equilibrium content in pure water film, obtained from Table data according to Henry law for liquid temperature,  $c^*$ .

*The agreement of experimental data and theoretical calculated oxygen solubility degree in the previous paper enables vibration energy of specifically chemisorbed oxygen equal to energy difference between stationary and equilibrium oxygen energy levels activated in oxygen fastest depolarization step:*

$$F\eta_{\min} = (E_s - E^*)_{\text{O}_2\text{-aq}} = RT \quad (1)$$

It controls relaxation step and oxygen distribution between stationary and equilibrium energy states, dependent on aeration treatment: according to Boltzmann distribution law, distribution due to diffusion mass transport, the parallel diffusion and standard potential of indicator of stationary corrosion (Ševaljević, M. V. et al., 2015).

Also linear functional dependence is found of oxygen solubility degree on calculated chemisorptions water vapor content in bubble surface (Ševaljević, M. V. et al., 2015):

$$w_s = -0.0581 \cdot \Delta c_{ad.w.v.} + 0.6376$$

$$(R^2 = 0.7667)$$
(2)

In this present paper it is predicted that obtained correlation explain oxygen kinetic energy in equilibrium energy state i.e., its gas pressure conservation law in period of adsorbed water vapor electron titration, keeping stationary kinetic energy of oxygen and hydrogen, up to water vapor end titration point:

$$p_{O_2}^* = W_{st}(O_2) + \Delta c_{ad.w.v.} \cdot \frac{F \cdot \eta_{H_2}}{\varepsilon_r(O_2^-)}$$
(3)

This used parameters are expressed on the basis its definitions ( Simić S.N. et al, 2014):

$$p_{O_2}^* = \frac{2}{3} W_{kinO_2}^*$$
(4)

$$W^* = \cdot \varepsilon_r(O_2^-) \cdot W_{p\ kLa=kdr}^\theta \cdot c^*$$
(5)

Oxygen molar transport with equal oxygen introduction and oxygen drift rate constant enable liquid water densities at water vapor critical point (Stanojević, M. M., et al., 2013):

$$W_{p\ kLa=kdr}^\theta = 22410 \text{ kJmol}^{-1}$$
(6)

Its combination after the rearrangement gives:

$$w_s = \frac{2}{3} \frac{\eta_{H_2}}{\varepsilon_r(O_2^-) \cdot c^* \cdot W_{kLa=kdr}^\theta} \Delta c_{w.v.}$$
(7)

The combination with previously obtained electrochemical couple of hydrogen and oxygen over-potential (Simić S.N. et al., 2014):

$$F \cdot \eta_{H_2} = 2 \cdot (W^{st} - W^*)_{O_2}$$
(8)

enables to obtain theoretical value of oxygen solubility degree, dependent on adsorbed water vapor content in surface of chemisorbed superoxide anion (calculated previously on the basis of water vapor adsorption heat (Ševaljević, M. V. et al, 2015)):

$$w_{s,calc} = \frac{0.66 \varepsilon_r(O_2^-) - 2 \Delta c_{w.v.}}{\varepsilon_r(O_2^-) - 2 \Delta c_{w.v.}}$$
(9)

## EXPERIMENTAL AND THEORETICAL RESULTS

Experimental work (Simic, N.S., 2006) was performed at batch working conditions and varying air flow of 2 and 10 m<sup>3</sup>/h. The water level in the column was 1 and 2 m high and the total volume was 490 and 980 L. Water aeration with waste oil added content of 5 and 10 mg/L in primary purified wastewater was performed, of the viscous waste motor oil, SAE 15 W-40, with 132.0 mm<sup>2</sup>/s. Dissolved oxygen was previously removed using a chemical method. Air flow regulation is performed using a flow regulator and relieving valve until a set value for the adopted investigation regime is attained. Air flow is stabilized at over-pressure value before distributor, when the first air bubble entered in the water. Water sampling from the column in equal time intervals starts ( $\Delta\tau = 60$  s) and the dissolved oxygen content,  $c_s$  is measured with HANNA instrument with polarographic sensors (with accuracy 0.05 g/m<sup>3</sup>) up to the measured saturation period is achieved,  $\tau_{s,exp}$  when the same value is repeated three times,  $c_s$  that enable to calculate a ratio with oxygen equilibrium concentration in pure water i.e., oxygen solubility degree:

$$w_s = c_s / c^*$$
(10)

Table 1 The comparison of diagnostic results of oxygen saturation degree with its experimental values

Regimes c-h-q	$t_L$ °C	$\gamma^{st}$ mgL <sup>-1</sup>	$\gamma^*$ mgL <sup>-1</sup>	$w_s$ , Eq. (10)	$w_{s,calc}$ Eq. (9)	$ \rho(w_s) $ / % Eq.(11)
0-2-2	13	7,5	10,56	0,71	0,73	2,76
0-2-6	13	7,6	10,56	0,72	0,74	2,73
0-2-10	14	7,9	10,39	0,76	0,76	0,00
5-2-2	15	6,4	10,32	0,63	0,66	4,63
5-2-6	12,1	6,7	10,63	0,63	0,66	4,63
5-2-10	14,5	7	10,29	0,68	0,66	2,97
10-2-2	13,5	5,9	10,35	0,57	0,61	6,75
10-2-6	13,2	6,1	10,52	0,58	0,6	3,37
10-2-10	14,1	6,4	10,32	0,62	0,58	6,63
5-1-2	14,9	6,4	10,16	0,63	0,65	3,11
5-1-6	15,6	6,6	10,00	0,66	0,64	3,06
5-1-10	15,8	6,5	9,85	0,66	0,64	3,06
10-1-2	14,9	5,8	10,18	0,57	0,64	11,51
10-1-6	14,8	6	10,17	0,59	0,63	6,52
10-1-10	14,9	5,9	10,17	0,58	0,62	6,63

The relative departure between calculated and measured values of oxygen saturation degree is calculated:

$$|\rho(w_s)| / \% = 100 \frac{w_{s,calc} - w_{s,exp}}{w_{s,calc}} \quad (11)$$

The agreement between experimental and theoretical results within relative error u% 2.8 % in the regime without added oil, 3 to 4.6 % in the regime with 5gm<sup>-3</sup> added oil, 3 to 6.6. % in the regimes with 10gm<sup>-3</sup> added oil to maximal 11.5 % for the regime 10-1-2 verify:

- the theoretical prediction of conservation energy law during gas oxygen equilibrium transport work
- the diagnostics method of water vapor adsorption heat and of its contents dependent on aeration treatment
- the diagnostic method of oxygen and hydrogen over-potentials

## CONCLUSION

The conclusion remarks are as follows:

1. oxygen solubility degree theoretically calculated depending on adsorbed water vapor content in bubble surface and on relative electric permittivity of oxygen chemisorptions layer also could be relevant for atmospheric aerosols
2. In equilibrium energy level of gas oxygen equilibrium pressure integrate its charging energy in its polarization step to keep stationary temperature, with its discharging energy in depolarization step that control stationary oxygen partial pressure in gas bubble and water vapor adsorption heat
3. The new saturation and adsorption kinetic data and thermodynamic data for oxygen and hydrogen over-potentials modeled for gas bubble transported in aerated water will be used in the study:
  - of the hydrated and deposited indicators of cathode stripping and oxygen stationary introduction
  - and of its influence on energy efficiency of oxygen transport.

## REFERENCES

- Simic, N.S. Ph. D. Thesis, *Faculty of Mechanical Engineering, University in Belgrade*, 2006
- Simić, S.N. et al M.M. Ševaljević, M.M. Stanojević, P.V. Ševaljević, Thermodynamic diagnostic of the depolarization over-potentials and electron temperatures of contact surfaces in aerated wastewater, *Desalination and Water Treatment*, **52** (2014) 7065
- Stanojević, M. M. , M.M. Ševaljević, S.N.Simić, M.V. Ševaljević, Influence of the water height in aeration regimes with the same membrane diffuser on technical characteristics of aeration system *Desalination and Water Treatment*, **51** (2013) 4271
- Ševaljević, M. V. S. N. Simić, M. M. Stanojević, M. Pavlović, M. M. Ševaljević, Diagnostic of water vapor adsorption molar heat and accumulation at bubble surface during aeration treatment in saturation period *Journal of Applied Engineering Science*, **13** (2015) 225

## **SOIL AND DEGRADATION OF SOIL**



V International Conference  
„Ecology of urban areas” 2016

## EFFECT OF HEAVY METALS AND TEMPERATURES ON TRACE GAS EMISSIONS FROM AGRICULTURAL SOIL

Abdousalam A. ALGAIDI<sup>1\*</sup>, Hosam BAYOUMI HAMODA<sup>2</sup>, Hamed ABDORHIM<sup>3</sup>

<sup>1</sup>Sebha University, Faculty of Agriculture, Department of Soil Science, Sebha, Libya

<sup>2</sup>Óbuda University, Rejtő Sándor Faculty of Light industry and Environmental Protection Engineering, Institute of Environmental Protection Engineering, Budapest, Hungary

<sup>3</sup>Azzaytuna University, Faculty of Science, Department of Environmental Science, Tripoli, Libya

### ABSTRACT

*The studies were conducted to determine the trace gases emissions of nitric oxide (NO) and nitrous oxide (N<sub>2</sub>O) concentrations from slightly alkaline solonchak arable land soil samples of low humus content (Hungary) with 60% of water holding capacity, using chemiluminescent and gas chromatographic methods, respectively. Soil samples amended with three concentrations of cadmium (Cd) and lead (Pb) were studied in closed microcosms conditions at two different incubation temperatures (15 and 37°C). Results indicated that at 15°C, the emission of NO was sharply reduced after the 3<sup>rd</sup> day of incubation in both Cd and Pb contaminated soil samples to be 0 µg in the 8<sup>th</sup> day while at 37°C the gas was emitted but gradually decreased by increasing the incubation time. Moreover in Pb or Cd amended soil samples, the N<sub>2</sub>O gas production increased up to the 5<sup>th</sup> day of incubation and then was gradually reduced. On the other hand, the amount of gas emission in Cd contaminated soil was more than soil amended with Pb. The results illustrated that the trace gases were more emitted at 37°C than at 15°C. Finally, depending on the results obtained, it is important to consider that climatic changes and soil condition to prevent the denitrification.*

**Keywords:** NO and N<sub>2</sub>O emission; heavy metal; microcosm; temperature; soil contamination.

### INTRODUCTION

Agriculture is both a source and sink for greenhouse gases (GHGs) and intensification of land use has increased the exchange of carbon (C) and nitrogen (N) between the land and the atmosphere. Concentrations of atmospheric GHGs, such as carbon dioxide (CO<sub>2</sub>), methane (CH<sub>4</sub>), and nitrous oxide (N<sub>2</sub>O), and etc. which can alter the earth's climate have risen dramatically during the past century. This has resulted in an urgent need for process-based understanding of the main factors influencing the exchange of these gases between the land and atmosphere at a range of scales, as a route to developing effective mitigation technologies. Most of the nitrogen oxides (NO<sub>x</sub>) are generated from mineral N originating from animal dung and urine, biologically fixed N<sub>2</sub>, and mineralization of soil organic N. Atmospheric N<sub>2</sub> is fixed into ammonia (NH<sub>3</sub>) by free-living and symbiotic bacteria and archaea (diazotrophs), using the nitrogenase enzyme, the universal catalyst, to break the N<sub>2</sub> triple bond. In soil, NH<sub>3</sub> can be converted into ammonium ion (NH<sub>4</sub><sup>+</sup>), which can be oxidized to nitrate ion (NO<sub>3</sub><sup>-</sup>), in a three-step process called nitrification. Nitrite (NO<sub>2</sub><sup>-</sup>) and NO<sub>3</sub><sup>-</sup> ions are generated during nitrification and they may be reduced during the denitrification process, that is the stepwise reduction of NO<sub>3</sub><sup>-</sup> to N<sub>2</sub> by four enzymes, generating intermediate products: NO<sub>2</sub><sup>-</sup>, NO and N<sub>2</sub>O. During the NO<sub>3</sub><sup>-</sup> ammonification to NH<sub>4</sub><sup>+</sup>, via NO<sub>2</sub><sup>-</sup>, it can occur NO<sub>3</sub><sup>-</sup> reduction, thus producing N<sub>2</sub>O (Thomson et al. 2012). The dominant sources of N<sub>2</sub>O are closely related to microbial production processes in soils, sediments and water bodies. Agricultural emissions owing to N fertilizer use and manure management (4.3–5.8 Tg N<sub>2</sub>O–N yr<sup>-1</sup>) and emissions from natural soils (6–7 Tg N<sub>2</sub>O–N yr<sup>-1</sup>) represent 56–70% of all global N<sub>2</sub>O sources (Syakila and Kroeze, 2011). Microbial nitrification and denitrification in managed and natural soils contribute approximately 70% of global N<sub>2</sub>O emissions. Braker and Conrad (2011).

Nitric oxide in soil is produced predominantly by nitrification and denitrification. Nitrification is the oxidation of NH<sub>4</sub><sup>+</sup> to NO<sub>3</sub><sup>-</sup>, denitrification is the anaerobic reduction of NO<sub>3</sub><sup>-</sup> to gaseous forms of N.

NO is by-product of the nitrification pathway and the typical yield of NO in well aerated soil ranges from 1% to 4% of the  $\text{NH}_4^+$  oxidised (Hutchinson and Brams 1992). NO is also a direct intermediate of the denitrification pathway, the reduction of  $\text{NO}_3^-$  to  $\text{N}_2$ . In soil, several processes considered responsible for nitrous oxide production, including autotrophic nitrification, heterotrophic nitrification, dissimilatory reduction of  $\text{NO}_3^-$  to  $\text{NH}_4^+$ , denitrification, and other reducing biological processes by common bacteria not typically defined as denitrifiers and nonbiological reactions. These processes cover a wide range of metabolisms, from autotrophic to heterotrophic, from oxidative to reductive. Consequently, different nitrogen (N) forms can have different effects on soil N transformations and  $\text{N}_2\text{O}$  emissions, as they kinds of soil microorganisms. Because of increasing the soil pollution with heavy metal due to the human activities, there was a reducing in the soil quality and soil fertility.  $\text{N}_2\text{O}$  is involved in global warming and the destruction of stratospheric ozone (Bouwman, 1990). Dynamic models which have been developed for emitting  $\text{NO}_x$  are just partly operative; they are not able to take into consideration spatial and temporal variability of the emission influencing factors (soil humidity, mineralization, nitrification, etc). However, all approaches have lead to formulation of the alternative soil usage strategies with the purpose of reducing  $\text{NO}_x$  emission in the manure soils. (Skiba et al., 1997). Heavy metals known to influence the activity of soil microbial communities, affecting the soil respiration, soil biomass, N-mineralization and nitrification (Giller et al., 1998). The application of fertilisers is essential to optimal nutrient supply of plants but the extended uses of N-fertilisers induce problems in soil-plants-animals/people food chain. The  $\text{NO}_3^-$  leaching into surface and groundwater and accumulation in plants has harmful human effects. The negative impact of overdose also causes agricultural problems e.g. overturning the balance between pests and their parasites in soil ecosystem (Nádasy and Nádasy, 2006).

## MATERIALS AND METHODS

The microcosm experiment conducted in glass vessels covered gas tightly by silicone septa. 200 g homogenised (< 2 mm) slightly alkaline solonchak arable land soil samples of low humus content were placed into the vessels of 1200  $\text{cm}^3$ . The soil samples collected from the upper 200-250 mm layer after removing the top 20-30 mm from a sample site. The soil samples were collected from the maize cultivated field experimental station of Georgikon Faculty of Agriculture, University of Pannon, Keszthely. The most important physical and chemical properties of the soil are  $\text{pH}_{(\text{KCl})}$  7.55, total salt content 0.054%, humus 1.48%, total organic C 1.08 %, total N 0.08 %,  $\text{NH}_4^+\text{-N}$  0.53  $\text{mg } 100\text{g}^{-1}$ ,  $\text{NO}_3^-\text{-N}$  0.18  $\text{mg } 100\text{g}^{-1}$ ,  $\text{K}_2\text{O}$  136  $\text{mg } 100\text{g}^{-1}$ ,  $\text{P}_2\text{O}_5$  130  $\text{mg } 100\text{g}^{-1}$ , density 2.45  $\text{g } \text{cm}^{-3}$  and C/N ratio 13.15. The soil samples at 60% of water holding capacity were contaminated by the addition of different doses of  $\text{Pb}(\text{CH}_3\text{COO})_2 \cdot 3\text{H}_2\text{O}$  at 40, 80 and 160  $\text{mg Pb kg}^{-1}$  soil and  $\text{CdCl}_2 \cdot 2.5\text{H}_2\text{O}$  at 6, 12 and 24  $\text{mg Cd kg}^{-1}$  soil. The vessels incubated in a laboratory thermostat at 15 and 37 °C for 35 days. During the experiments, NO and  $\text{N}_2\text{O}$  gas samples were taken from the headspace of each vessel determined regularly by gas chromatographic method. A 250- $\mu\text{l}$  gas sample taken by gas tight Hamilton syringes and was injected from each vessel to the HP 5890 gas chromatograph. Packed columns (Porapak Q) used to separate the different constituents of gas samples.

Electron Capture Detector (ECD) and Thermal Conductivity Detector (TCD) detected  $\text{N}_2\text{O}$  concentrations, respectively. The separated gas content was analysed three times per day whenever measurements carried out using external standard and one point linear calibration. The NO gas emission detected by chemiluminescent detector (Model 7050 analyzer of ANTEK Instruments L.P., USA) which is specifically designed for the analysis of NO in samples. The most important characteristics of GC and NO-measurements can be shown in Tables 1 and 2, respectively.

Table 1. The most important characteristics of GC

<b>GC analysis of gas samples</b>	<b>HP 5980 Series II type gas chromatograph</b>
Analysed gase	N <sub>2</sub> O
Carrier gases and flow rates	N <sub>2</sub> : 23ml/min
Temperature of Injector	70°C
Columns (temperature of oven is 50 °C)	Porapak Q (80/100 mesh, 6ft)
Detectors (temperature)	ECD (250°C)
Calibration	External standard
Calibration gas mixture contains	7.9 v/m N <sub>2</sub> O
Evaluation of chromatograms	HP 3390 Ser. II integrator, HP CHEM

Table 2. The most important characteristics of NO analyzer

<b>NO-analysis of gas samples</b>	<b>Antek 7050 Nitric oxide analyser</b>
Analysed gas	NO
Carrier gas	He
Gas for ozone generation	O <sub>2</sub>
Temperature of photomultiplier	5 °C
Detector	chemiluminescent
Calibration gas mixture contains	1 ppm NO
Evaluation of peak areas	HP 3390 Ser. II integrator, HP CHEM

## RESULTS AND DISCUSSION

During the nitrification, the N of the NH<sub>4</sub><sup>+</sup> ion is transformed into NO<sub>2</sub><sup>-</sup> and NO<sub>3</sub><sup>-</sup> -N. Soil NO<sub>3</sub><sup>-</sup> and NH<sub>4</sub><sup>+</sup> content during the experimental period were decreased. Generally the temperature of incubation is a key factor controlling the origin of trace gases emissions. For all treatments, denitrification was the main source of trace gases emissions during the incubation period, because WFPS was 60% on most days. In the first period of the experiment the N<sub>2</sub>O emissions from soil raised due to the increase of microbiological activity and the acceleration of soil organic matter mineralization after drying and rewetting of soil.

### Production of NO

Figure 1 illustrates that the rate of NO production in control soil with 60% WFPS was significantly reduced during increasing the incubation time at 37°C. Nevertheless, when the microcosms incubated at 15°C (Fig. 2), the trace gas production rate during the first 3 days was increased three times of those incubated at 37°C and the suddenly decreased to minimum after 5 days of incubation and then the rate of emission became zero µg/l. Comparatively, similar results obtained in Cd or Pb contaminated soils at different concentrations. However, the rate of the trace gas emission was higher from soil contaminated with Cd than from soil contaminated by Pb. The results of the present study indicated that 6 mg Cd kg<sup>-1</sup> soil promoted the emission of NO at 37°C. Also, Cd showed lower toxicity than Pb regarding to the rate of NO emission.

From Figures 1 and 2 we can found that the magnitude of NO emission from soil depends on the rates of nitrification and denitrification and the diffusion properties of the soil. In developing mitigation options the most important parameters that influence the emission rate are the concentration of mineral N in the soil, the soil temperature and soil variables which regulate gaseous diffusivity, including texture, bulk density and soil water content. These factors should be considered in agricultural practice.

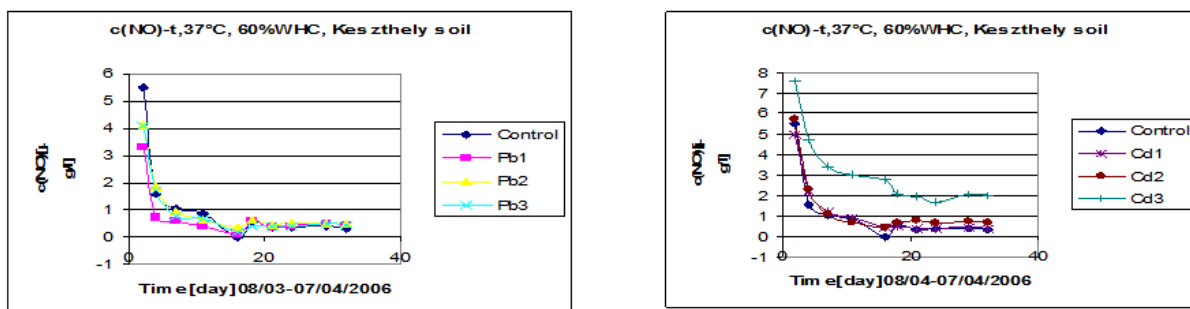

Figure 1. Nitric oxide amounts detected in microcosm containing Ramann's brown forest soil (Keszthely) of 60% WFPS treated with different concentrations of Cd and Pb incubated at 37°C.

Here, our results are in an agreement with the conclusion of Skiba et al. (1997). Remde et al. (1989) mentioned that denitrification was shown to produce up to twice as much NO as nitrification. However, the net release of NO from soil is greatly influenced by the gas phase diffusivity in soil and the rate of NO consumption by denitrifiers. Taking in the consideration that soil WFPS was 60%, in this situation anaerobic condition is created, and the probability of NO being reconsumed by the denitrifiers is greatly enhanced.

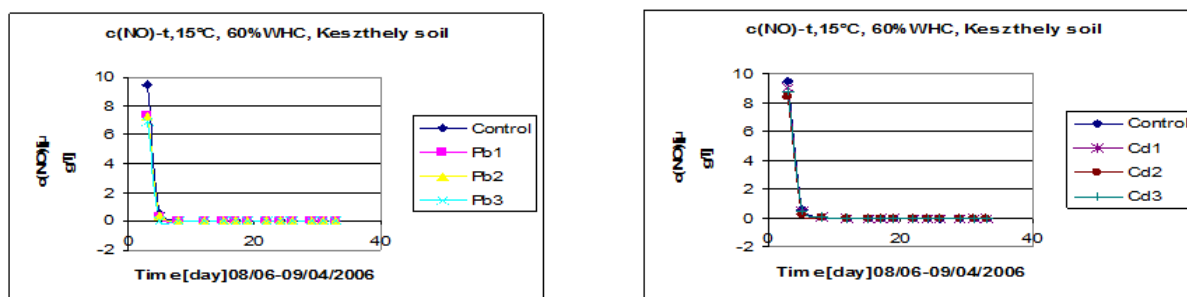

Figure 2. Nitric oxide amounts detected in microcosm containing Ramann's brown forest soil (Keszthely) of 60% WFPS treated with different concentrations of Cd and Pb incubated at 15°C.

## Production of N<sub>2</sub>O

Denitrification was the main process responsible for total N<sub>2</sub>O emissions from soil. N<sub>2</sub>O emissions were influenced by the contamination of soil by Cd or Pb and several peaks were registered for each treatment during the experimental period at low (15°C) and high (37°C) incubation temperatures (Figs. 3 and 4, respectively). The highest N<sub>2</sub>O emission was observed in Cd amended soil between 1st and 10th day of incubation at 37°C.

The gas emission flux from microcosms during the incubation period did not show significant differences ( $P < 0.05$ ) at low incubation temperature and between the metal contaminated soils compared to the high incubation temperature.

The rate of N<sub>2</sub>O produced in the microcosms incubated at 37°C was decreased (statistically is not significantly) with increasing either Cd or Pb concentrations. Figure 3 shows that in the microcosms containing Pb contaminated soil with 40 mg Pb kg<sup>-1</sup> soil stimulated the production rate of the N<sub>2</sub>O compared with control soil. However, the increasing Pb concentration, the rate of the emission was decreased. On the other hand, Cd stimulated the gas production at all concentrations especially 6 mg Cd kg<sup>-1</sup>.

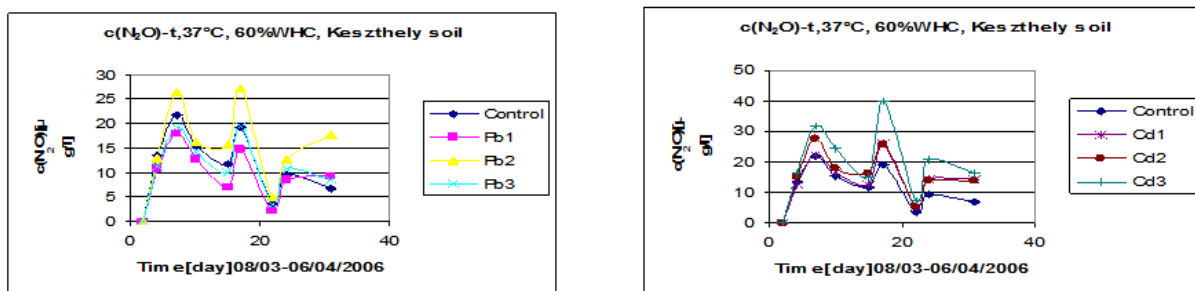

Figure 3. Nitrous oxide amounts detected in microcosm containing Ramann's brown forest soil (Keszthely) of 60% WFPS treated with different concentrations of Cd and Pb incubated at 37 °C.

Figure 4. illustrates that the rate of  $N_2O$  produced in the microcosms containing Pb contaminated soil incubated at 15°C was reduced by 50% in comparison with the production rate at 37°C. But the reduction of gas emission in soil contaminated with Cd was 65%. The results indicated that under similar conditions, temperature is significant factor in the production of the gas. Higher gas emission in soil amended with Cd than in Pb contaminated soil was observed. However, predicting gaseous losses of soil N, such as  $N_2O$ , is difficult because of the complexity of the N-cycling processes.

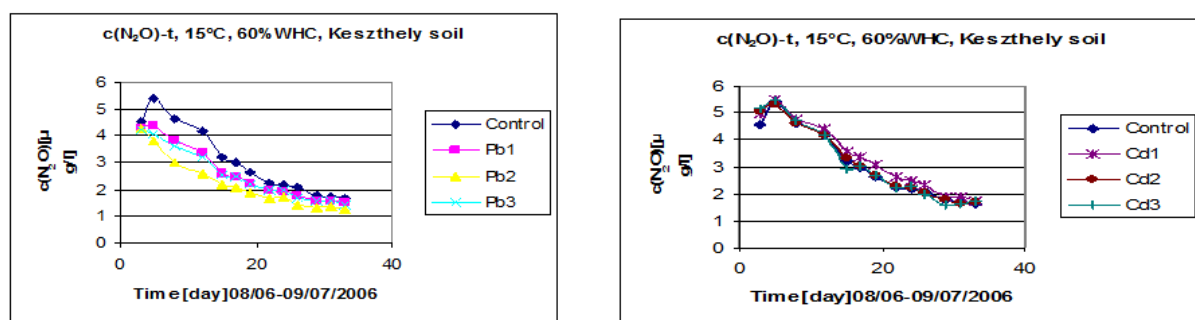

Figure 4. Nitrous oxide amounts detected in microcosm containing Ramann's brown forest soil (Keszthely) of 60% WFPS treated with different concentrations of Cd and Pb incubated at 15°C.

The rate of gas emission primarily depends on the availability of a mineral N source as a substrate of nitrification and denitrification,  $O_2$  supply, soil moisture, soil temperature, pH, salinity and availability of labile organic compounds (Smith et al., 2003). Our results are in an agreement with the conclusion of Smith et al. (2003). However, in most soils the dominance of nitrification or denitrification as main source of  $N_2O$  is not static and can switch very rapidly as the soil aeration state within the biologically active sites changes due to soil physical and chemical properties, climatic changes or increased  $O_2$  demand caused by the presence of easily mineralizable organic matter. In accordance to the effect of heavy metals on nitrification and denitrification, to some extent we agreed with Hinojosa et al. (2004). The different steps in the reduction of  $NO_3^-$  to  $N_2$  in denitrification appear to differ in their heavy metal tolerance. Holtan et al. (2002) mentioned that the immediate effect (one day of application) of heavy metals on denitrification. Increases in total Pb decreased the production of  $N_2O$  attributed to nitrification by the inhibition method, while increases in pH and total N increased it. Cela and summer (2002) and Rusk et al. (2004) noted that Pb did not inhibit nitrification. However, this effect was observed in our experimental model, in case of Cd (Figures 3 and 4) and only Pb at 40  $mg\ kg^{-1}$  soil stimulates the  $N_2O$  emission attributed to nitrification by the inhibition method. Sakadevan et al. (1999) mentioned that the effect of heavy metal addition on surface wetland sediments receiving wastewater found that the addition of 500 and 1000  $mg\ Cd\ kg^{-1}$  sediment significantly inhibited denitrification. Taking the results shown in Figures 3 and 4 together, it seems very likely that more frequent measurement of soil temperature would have given an even better prediction of  $N_2O$  emission fluxes from the soil under the stress of heavy metals. Conen et al. (2000) concluded that the emission flux of  $N_2O$  is depended on WFPS, soil temperature and mineral N content. However, it seems likely that this our results is confirmed by the conclusion of Conen et al. (2000).

## CONCLUSION

At constant soil humidity, pH, and C: N ratio, our results indicated the following points: at the incubation temperature at 37°C increased the production rates of the NO and N<sub>2</sub>O more than at 15°C, Pb concentration over 40 mg/kg soil caused a reduction in trace gas production, Cd had low toxicity toward the nitrification or denitrification at all concentrations compared with Pb effects. Cd and Pb significantly high reduced the rate of NO production especially at 15°C. At 37°C, the higher rates of NO, N<sub>2</sub>O production found in Cd contaminated soil at all tested concentrations.

## REFERENCES

- Thomson, A. J., Giannopoulos, G., Pretty, J., Baggs, E. M., and Richardson, D. J. (2012). Biological sources and sinks of nitrous oxide and strategies to mitigate emissions. *Philosophical Transactions of the Royal Society Biological Sciences*, London. 367, n. 1593, p. 1157-1168.
- Syakila, A., and Kroeze, C (2011). The global nitrogen budget revisited. *Greenhouse Gas Meas. Manage.* 1, 17-26 (doi:10.3763/ghgmm.2010.0007)10.3763/ghgmm.2010.0007
- Braker G., and Conrad R. (2011). Diversity, structure, and size of N<sub>2</sub>O-producing microbial communities in soils—what matters for their functioning? *Adv. Appl. Microbiol.*, 75, 33-70
- Bouwman, A. F. (1990). Exchange of greenhouse gases between terrestrial ecosystems and the atmosphere. In: *Soils and the Greenhouse Effect.* (ed.: Bouwman, A.F.) 100-120. Wiley,Chichester.
- Cela, S., and Summer M. E. (2002): Critical concentrations of copper, nickel, lead, and cadmium in soils based on nitrification. *Commun. Soil Sci. Plant Anal.*, 33: 19-30.
- Conen, F., Dobbie, K. E., and Smith K. A. (2000). Predicting N<sub>2</sub>O emissions from agricultural land through related soil parameters. *Global Climate Biology*, 6, 417-426.
- Giller, K. E., Witter, E., and McGrath, S. P. (1998): Toxicity of heavy metals to microorganisms and microbial processes in agricultural soil: a review. *Soil Biol. Biochem.*, 30: 1389-1414.
- Hinojosa, M. B., García-Rusíz, R., Viñegla, B., Carreira, J. A. (2004). Microbiological rates and enzyme activities as indicators of functionality in soils affected by the Aznalcóllar toxic spill. *Soil Biol. Biochem.*, 36, 1637-1644.
- Holtan-Hartwig L., Bechmann M., Risnes H.T., Linjordet R., Reier Bakken L. (2002): Heavy metals tolerance of soil denitrifying communities: N<sub>2</sub>O dynamics. *Soil Biol. Biochem.*, 34: 1181-1190.
- Hutchinson, G. L., and Brams, E. A. (1992). NO versus N<sub>2</sub>O 13017-13031. Emissions from an NH<sub>4</sub>:-amended Bermuda grass pasture. *J. Geophys. Res.*, 97. 9889-9896.
- Nádasy, E., and Nádasy, M. (2006). Some harmful or useful environmental effect of nitrogen fertilisers. *Cereal Res. Commun.*, 34: 49-52.
- Remde, A., Slemr, F., and Conrad, R. (1989). Microbial production and uptake of nitric oxide in soil. *FEMS Microbiol. Ecol.*, 62: 221–230.
- Rusk, J. A., Hamon, R. E., Stevens, D. P., and McLaughlin, M. J. (2004). Adaptation of soil biological nitrification to heavy metals. *Environ. Sci. Technol.*, 38, 3092-3097.
- Sakadevan, K., Zheng, H., and Bavor, H. J. (1999). Impact of heavy metals on denitrification in surface wetland sediments receiving wastewater. *Water Sci. Technol.*, 40, 349-355.
- Skiba, U., Fowler, D., and Smith, K. A. (1997). Nitric oxide emissions from agricultural soils in temperate and tropical climates: sources, controls and mitigation options. *Nutr. Cycl. Agroecosyst.*, 48, 139-153.
- Smith, K. A., Ball, T., Conen, F., Doddie K. E., Massheder J., and Rey A. (2003). Exchange of greenhouse gases between soil and atmosphere: interactions of soil physical factors and biological processes. *Euro. J. Soil Sci.*, 34, 779-791.

V International Conference  
„ECOLOGY OF URBAN AREAS“ 2016

**ECOLOGICAL AND FUNCTIONAL ROLES OF PGPR IN BROWN  
FOREST SOIL ECOSYSTEM OF GÖDÖLLŐ, HUNGARY**

**Hosam BAYOUMI HAMUDA<sup>1\*</sup>, Abdoussalam A. KHALIF<sup>2</sup>**

<sup>1</sup>Óbuda University, Rejtő Sándor Faculty of Light industry and Environmental Protection Engineering, Institute of Environmental Protection Engineering, Budapest, Hungary

<sup>2</sup>Tripoli University, Faculty of Agriculture, Tripoli, Libya  
bayoumi.hosam@rkk.uni-obuda.hu\*; khalif\_salam.yahoo.com

**ABSTRACT**

*Biocomponents of PGPR are based on diverse genetic and functional groups of soil microbial populations were used to maintain the quality and sustainability of soil resources and responsible for critical ecosystem functions such as the biogeochemical cycling of nutrients, maintenance of plant health and soil quality, optimizing the stability and productivity of soil ecosystem, prevent erosion and minimize negative environmental stresses. Effective PGPR Selection is the most critical aspect to have maximum benefits from this technology. A single or multiple inoculants were introduced to the rhizospheres of young sunflower seedlings grown in sterile and unsterile clay loam brown forest soil of 50% moisture content at 28°C in greenhouse pot experiments for 9 weeks. The results showed that inoculation of soil with the characterized strains of *Pseudomonas fluorescens*, *Bacillus subtilis*, *Saccharomyces cerevisiae* and *Trichoderma viride* achieved sunflower growth more than those achieved by NPK fertilization. Nevertheless, the novel observations described main points forward in achieving the biotechnological challenging goal for increasing crop productivity by reducing its dependence on the agrochemicals. The future success of the biocontrol industry will benefit from interdisciplinary research, e.g., on mass production, formulation, interactions, signalling with the environment and on innovative business management. Exploitation of beneficial plant-microbe interactions offers promising and environmentally friendly strategies for conventional and organic agriculture worldwide.*

**Keywords:** *Microbial selection, PGPR, soil biochemical activities, soil quality, sunflower growth.*

**INTRODUCTION**

Today, the world relies on increasing crop production to meet the increasing demand for food. However, this trend cannot be maintained due to decreasing cultivable land for rapid urbanization. A large community of plant growth-promoting rhizomicrobiomes (PGPR) that provide to the plants the essential services, such as increase mineral uptake, nitrogen-fixation, solubilisation of phosphate, stimulation and promotion the growth, protection the plants from pathogens, production of siderophore, cleaning the rhizosphere from the organic pollutants, etc. These plant root microbiotas are predominantly in the rhizosphere and can be selected for by the plant. This type of selection is based on the plant-microbe interaction which is focused on understanding plant-beneficial functions that are encoded by the root microbiome and the role of plant genes that aid in maximizing profitable functions from the root microbiome.

Selected PGPR improve plant health by stimulating the production of phytohormones increasing plant's immune system through the phenomenon called induced systemic resistance (ISR). Our recent work highlights the role of rhizobacterial volatiles in this process and provides a thus far unidentified mechanistic link between the ability of rhizobacteria to stimulate systemic immunity and Fe uptake mechanisms in host plants (Bayoumi Hamuda and Patkó, 2012). Current research is focused on understanding early root-microbiome interactions with the ultimate goal to develop future crops that are better able to maximize profitable functions from their root microbiome.

Rhizospheric microorganisms can promote solubilisation of insoluble Ca-phosphates and hydrolysis of organic P forms, thus, increasing P availability to plants (Oliveira et al., 2009). Mobilization of P in the rhizosphere is a common mechanism of PGPR for enhancing plant development (Richardson et al., 2009). PGPR have other potential benefits for plants derived from stimulation of plant growth by phytohormones production, improving uptake of other nutrients, or reducing biotic or abiotic plant stress without pathogenic effects (Bhattacharyya and Jha, 2012; Lakshmanan et al., 2013).

There is a wide range of soil microorganisms, contributing to some of the most important processes in the soil necessary for efficient soil quality and soil production as well as health plant growth. In addition, soil microorganisms are interactive antagonistically or synergistically affecting their efficiency in the soil. Such a property can also influence the production and use of bioinoculants or biofertilizers.

Thus, manipulating the plant rhizosphere with microorganisms, additionally having positive agricultural effects such as reducing biotic stress and improving plant nutrition, might be an effective approach to promoting cost-effective integrated management practices (de Santiago et al., 2013). Phytobiostimulants include diverse substances and rhizomicrobiomes that enhance plant growth. “Biostimulants foster plant growth and development throughout the crop life cycle from seed germination to plant maturity in a number of demonstrated ways, including but not limited to: improving the efficiency of the metabolism of plant to induce yield increases and enhanced crop quality; increasing plant tolerance to and recovery from abiotic stresses; facilitating nutrient assimilation, translocation and use; enhancing quality attributes of produce, including sugar content, colour, fruit seeding, etc.; rendering water use more efficient; enhancing certain physicochemical properties of the soil and fostering the development of complementary soil microbes”.

During the last two decades, the application of microbial inoculants in agriculture has greatly increased. Biofertilizers are biological products containing rhizomicrobiomes that, when applied to seed, plant surfaces, or soil, promote growth by several mechanisms such as increasing the supply of nutrients, increasing root biomass or root area, and increasing the potential of plant nutrient uptake. Microbial inoculants mainly include free-living bacteria, fungi, (Dodd and Ruiz-Lozano 2012) or others that were isolated from a variety of environments including soil, plants, plant residues, water, and composted manures.

Soil inoculation by PGPR especially species of soil useful rhizomicrobiomes e.g., *Pseudomonas*, *Rhizobium*, *Bacillus*, *Trichoderma*, *Saccharomyces*, etc. are model root microbiomes to demonstrate influence on plant health. Based on these beneficial plant-microbe interactions, it is possible to develop microbial inoculants for use in agricultural biotechnology. The soil biological properties were studied by means of measurements of microbial biomass carbon or nitrogen (MBC) or (MBN), basal respiration (BR), and soil enzyme activities.

## **MATERIALS AND METHOD**

PGPR can be used both under stress for alleviating the stress on plant growth and used singly or in combination with other forms of fertilization including chemical and organic or inorganic to increase plant growth and yield production. The selection of the appropriate strains for the enhanced efficiency of PGPR under different conditions is of significance. It indicates that PGPR must be exactly screened for their growth promoting characters, and be tested under different conditions including stress for the selection of the most efficient strains.

In search of efficient PGPR strains with multiple activities, a total of 88 microbial isolated belonging to the genera: *Pseudomonas*, *Bacillus*, *Saccharomyces* and *Trichoderma* were selected for further



investigations. The isolates were screened *in vitro* for their PGP traits like production of indole acetic acid (IAA), ammonia (NH<sub>3</sub>), hydrogen cyanide (HCN), siderophore, phosphate solubilisation and antifungal activity. More than 80% of the isolates of *Pseudomonas*, *Bacillus*, *Saccharomyces* and *Trichoderma* produced IAA, whereas only 20% of *Bacillus* isolates was IAA producer. Phosphate solubilisation was commonly detected in the isolates of *Bacillus* (83%) followed by *Pseudomonas* (75%), *Saccharomyces* (55.56%) and *Trichoderma* (46.67%). All tested isolates could produce NH<sub>3</sub> but none of the isolates hydrolysed chitin except *Trichoderma* isolates. Production of siderophore and antifungal activity of these isolates were exhibited by 76.4% of isolates. HCN production was more common trait of *Pseudomonas* (88.71%) and *Bacillus* (56%). On the basis to form a multiple inoculant as PGP activities, 16 of microbial isolates were evaluated for their quantitative IAA production and antifungal activity against three phytopathogenic fungi were investigated. Almost at all concentration of tryptophan (50-500 mg/ml), IAA production was highest in the *Pseudomonas* followed by *Saccharomyces*, *Trichoderma* and *Bacillus* isolates. *Trichoderma*, *Pseudomonas*, *Saccharomyces* and *Bacillus* showed broad-spectrum antifungal activity on Muller-Hinton medium against *Alternaria* sp., *Fusarium solani*, *Pythium ultimum* and *Rhizoctonia solani*. Expanding the metabolic functions of such isolates, it was found that all isolates were able to degrade 2,4-D and tolerate 80-160 mg of Cd, Pb, Cu, Ni/kg soil and 160-320 mg of Zn, Mn/kg soil prove to be a useful strategy for bioremediation. Further evaluation of the isolates was carried out to exhibit PGP traits on soil-sunflower agroecosystem. The selected isolates were identified finally as *P. fluorescens* (03-GPF), *B. subtilis* (03-BS), *S. cerevisiae* (03-SC) and *T. viride* (03-GTV). The selection was according to their high characterization to *in vitro* and *in vivo* experiments. On the basis of recent studies were carried out *in vitro* for selection of PGPR tolerant strains to high temperature, dryness, acidity, heavy metals, pesticides, inorganic fertilizers using solid and liquid media, and then in a greenhouse pot experiments, a single or multiple inoculants at equal colony forming unit per millilitre (1:1:1:1) were introduced to sunflower of 14 days old seedlings grown in sterile and non-sterile clay loam brown forest soil samples (originated from Gödöllő, Hungary) of 50% moisture content at 28°C. Biochemical and microbial activities in the plant rhizosphere and plant growth were investigated after 9 weeks of inoculation.

The results were present in comparison with control soil, soil treated with recommended NPK (1:1:1). Plant dry weight (air-dried oven at 70°C) was determined. The MBC was determined by the chloroform-fumigation–extraction procedure in which C is extracted by 0.5 M K<sub>2</sub>SO<sub>4</sub> before and after fumigation (Vance et al., 1987). Soil organic carbon (OC) was determined by wet oxidation with K<sub>2</sub>C<sub>2</sub>O<sub>7</sub> according to Walkley and Black (1934) method. MBC was calculated as:  $MBC = EC/kEC$ , where  $EC = (OC \text{ extracted from fumigated soils}) - (OC \text{ extracted from non-fumigated soils})$  and  $kEC = 0.45$  (Wu et al., 1990). The total N was measured by the Kjeldahl method (Bremner, 1982) and MBN was calculated as:  $MBN = EN/kEN$ , where  $EN = (total \ N \ extracted \ from \ fumigated \ soils) - (total \ N \ extracted \ from \ non-fumigated \ soils)$  and  $kEN = 0.54$  (He et al., 1997). MBP was calculated as:  $MBP = EP/kEP$ , where  $EP = (total \ P \ extracted \ from \ fumigated \ soils) - (total \ P \ extracted \ from \ non-fumigated \ soils)$  and  $kEP = 0.40$  (Öhlinger, 1996). Basal respiration (CO<sub>2</sub>-evolution) was measured by incubating fresh soil equivalent to 100 g dry weight at 28°C in 1000 ml air-tight jars for 14 days, adjusted to 50% of water holding capacity. In another beaker 50 ml of 1 M NaOH was placed inside the jar in order to trap the CO<sub>2</sub> evolved during the incubation period. 0.375 M BaCl<sub>2</sub> was added to NaOH to precipitate CO<sub>2</sub> as BaCO<sub>3</sub>. The excess of NaOH that did not react with the CO<sub>2</sub> was determined by titration with 1 M HCl. Hydrolysis of fluorescein diacetic acid (FDA) was evaluated according to the methods of Schnürer & Rosswall (1982) and expressed as µg fluorescein/g soil. The method of García et al. (1997) was used to determine the dehydrogenase activity (µg INTF/g soil/h). Acid phosphatase and β-glucosidase activities were determined (µg p-nitrophenol/g soil/h) by

spectrophotometry at 398 nm (Tabatabai and Bermned, 1969). Aryl-sulphatase activity was measured colorimetrically at 420 nm ( $\mu\text{g}$  p-nitrophenol/g soil/h) according to (Tabatabai and Bermned, 1970). All experiments were carried out in triplicates and complete randomized block system and the results are presented in the average of the replicates.

## RESULTS AND DISCUSSION

Sustainable agriculture is the fundamental important topic in the world today because it offers the potential to meet our future agricultural needs because of a fast growing population, something that conventional agriculture will not be able to do. In modern cultivation process, there is a wide indiscriminate use of chemical fertilizers, which has led to pollution of soil, air and water.

Worldwide growth in population, increase in the demand of global food production, and environmental damage causing problems in agriculture yield are major concerns to the world. These problems may soon cause insufficiency to feed all of the world's population (Ladeiro, 2012). Current population of world is 7 billion and expected to reach 10 billion by next 50 years. Agricultural strategies to feed all of these individuals are an important challenge in twenty-first century (Glick, 2014). For the same it is essential that agricultural productivity should be significantly increased within the next few decades.

Majority of credible group of PGPR belongs to genera *Acinetobacter*, *Agrobacterium*, *Arthobacter*, *Azotobacter*, *Azospirillum*, *Burkholderia*, *Bradyrhizobium*, *Rhizobium*, *Frankia*, *Serratia*, *Thiobacillus*, *Pseudomonads*, and *Bacillus* (Glick, 1995; Vessey, 2003).

Investigations showed statistically significant differences between the tested soil properties and application of the microbial combined inoculant of selected tolerant strains of *Pseudomonas fluorescens*, *Bacillus subtilis*, *Saccharomyces cerevisiae* and *Trichoderma viride* to ecological parameters *in vitro* are able to control heavy metal mobilization, pesticide degradation and suppress the tested phytopathogens in the rhizosphere of sunflower with adjusted mixing ratio (data not shown). Also, results indicated that soil inoculation by effective combination of *P. fluorescens*, *B. subtilis*, *S. cerevisiae* and *T. viride* as PGPR strains are required for maximizing sunflower yield in the term of dry weight (Figure 1) and protect plant disease and improve soil quality by increasing the organic carbon, total nitrogen and total phosphorus as well as the  $\text{CO}_2$ -released and microbial contents in the form of microbial biomass carbon, nitrogen and phosphorus, respectively MBC, MBN and MBP (Figure 2) and the potential enzymatic activities (Figure 3).

Figure (1) demonstrates that the sunflower dry matter was significantly lower in control soil. Also, the combined microbial inoculant enhanced the plant dry weight more than the application of NPK. The best plant production was recorded in combination PGPR microbial inoculant and NPK.

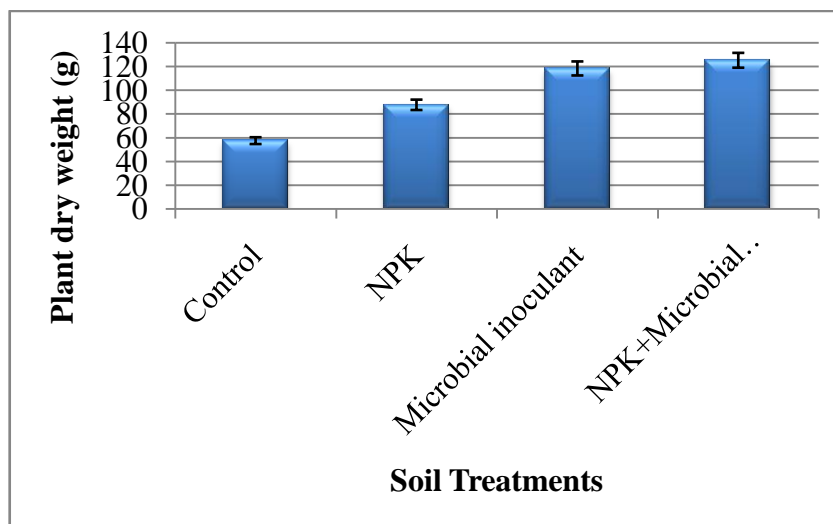

Figure 1. Effects of microbial inoculant and NPK application to clay loam brown forest soil on the growth of sunflower dry weight

The results of soil biological analysis determination are listed in Figure 2. Soil microbial respiration has been considered as a basic index for soil microbial activity. Figure (2) represents the PGPR microbial content and their activities in the sunflower rhizosphere, soil respiration as well as soil organic carbon (OC), total N and total P. It was established that control soil samples had low microbial activities, OC, total N and P and CO<sub>2</sub>-release. These parameters were improved when the soil condition is treated with or without NPK application in the presence of PGPR microbial inoculant. This means that the introduced selected rhizomicrobiomal inoculant can be well established in the all soil conditions without antagonistic effects, and increased the soil quality. Increasing the rate of soil respiration indicates that the soil PGPR microbial content is in dynamics and strengthens with it. The application of NPK at this ratio had no harmful effects on the biological processes in the rhizosphere of sunflower. But usually it improved the activity of the PGPR microbial inoculant and significantly improved the soil quality and plant production.

Depending on obtained results, we are in an agreement with Hayat et al. (2010) who mentioned that plant-bacterial interactions in the rhizosphere are the determinants of plant health and soil fertility. Free-living soil bacteria beneficial to plant growth, usually referred to as PGPR, are capable of promoting plant growth by colonizing the plant root. PGPR are also termed plant health promoting rhizobacteria. These are associated with the rhizosphere, which is an important soil ecological environment for plant-microbe interactions. PGPR have the potential to contribute to sustainable plant growth promotion.

Generally, PGPR function in three different ways: synthesizing particular compounds for the plants, facilitating the uptake of certain nutrients from the soil, and lessening or preventing the plants from diseases. Plant growth promotion and development can be facilitated both directly and indirectly. Indirect plant growth promotion includes the prevention of the deleterious effects of phytopathogenic organisms.

Several strains of rhizomicrobiomes may be found in the rhizospheric soil, on the root surface. PGPR also help in solubilisation of mineral phosphates and other nutrients, enhance resistance to stress, stabilize soil aggregates, and improve soil structure and organic matter content. PGPR retain more soil organic N, and other nutrients in the plant-soil system, thus reducing the need for fertilizer N and P

and enhancing release of the nutrients. The conclusion is proved in control soil condition where our strains can be established and however, colonized well the sunflower roots.

Bayoumi Hamuda and Patkó (2012) concluded that a key strategy to enhance the soil inoculant performance to increase plant growth and production is the selection of PGPR strains to improve  $N_2$ -fixation and to survive under stressful soil conditions and greater competitive ability in comparison with usage of agrochemicals. Our result (Figure 1) is agreed with de Souza et al. (2013) that bacteria which are able to colonize plant root systems and promote plant growth and crop yield through a variety of mechanisms. The continued use of chemical fertilizers and manures for enhanced soil fertility and crop productivity often results in unexpected harmful environmental effects. Integrated nutrient management systems are needed to maintain agricultural productivity and protect the environment. Microbial inoculants are promising components of such management systems (Adesemoye and Kloepper, 2009a).

Our results (Figures 2 and 3) are confirmed the results of Adesemoye and Kloepper (2009a) at which the level of organic carbon, total nitrogen and phosphorus increased by the establishment of microbial inoculant introduced to the soil under different soil conditions.

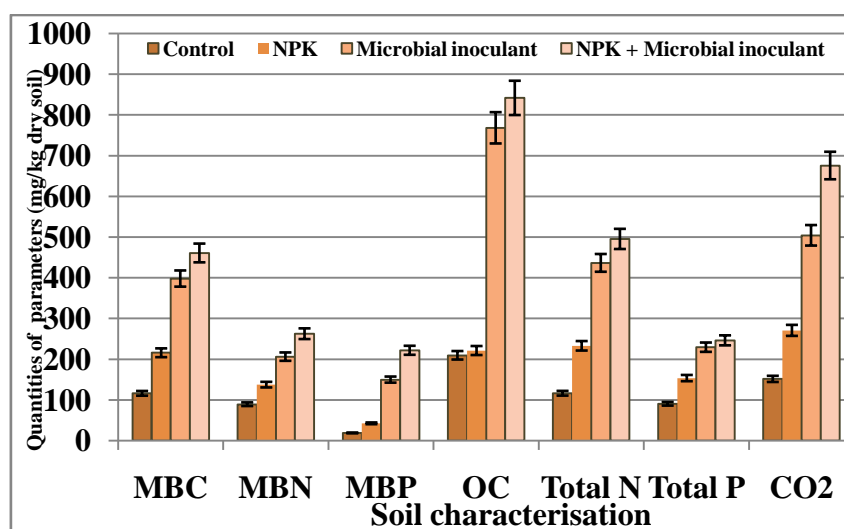

Figure 2. Effect of combined microbial inoculant with or without NPK application on microbial biomass C, N and P, soil OC, total N and P and CO<sub>2</sub>-release in clay loam brown forest rhizospheric soil of sunflowers

Ambrosini et al. (2012) concluded that *Enterobacter* and *Burkholderia* were the dominant rhizospheric bacterial genera associated with sunflower plants and inoculation with isolates belonging to the genera *Achromobacter*, *Chryseobacterium*, *Azospirillum*, and *Burkholderia* had a stimulatory effect on plant growth. *Agrobacterium*, *Burkholderia*, *Enterobacter*, and *Pseudomonas* were the most abundant among all the bacterial genera identified. Several of those bacteria could produce indolic compounds and siderophores, to solubilize phosphate, and some could also fix nitrogen. Some of the isolates tested for growth-promoting effects of bacterial treatment in canola were able to promote plant growth (Farina et al., 2012). Our recent experiments and the present results are in an agreement with conclusions of Ambrosini et al. (2012) and Farina et al. (2012).

Figure 3 shows the significant positive effects of the combined rhizomicrobiomes inoculant on soil biochemical activities in the term of potential enzyme activity. Consequently, it was found that the potential enzymatic activities in control soil samples were lower than those measured in microbial treated soils. Higher potential enzymatic activities were measured in soils inoculated by the microbial inoculant as well as with the addition of NPK as a stimulator dose to activate the microbial inoculant. According to our results, use of chemical fertilization is necessary as biofertilization to enhance its efficiency environmentally and economically using as biofertilizers. It has been indicated that about less than 50% of chemical fertilizers is absorbed by plant and the rest would not be accessible by plant as it is subjected to leaching, run-off and emission from the soil (Adesemoye et al., 2009a, b).

Accordingly, the proper application of chemical and microbiological fertilization is much dependent on realizing the interactions between soil, plant and microbiomes. Rhizospheric microbiomes are a big advantage to plant and the environment as they own some abilities that collectively enhance plant growth. Among such abilities enhanced nutrient uptake by plant is also of importance; in the presence of soil microorganisms, plant absorb higher amounts of nutrients and less risk of environmental pollution is likely.

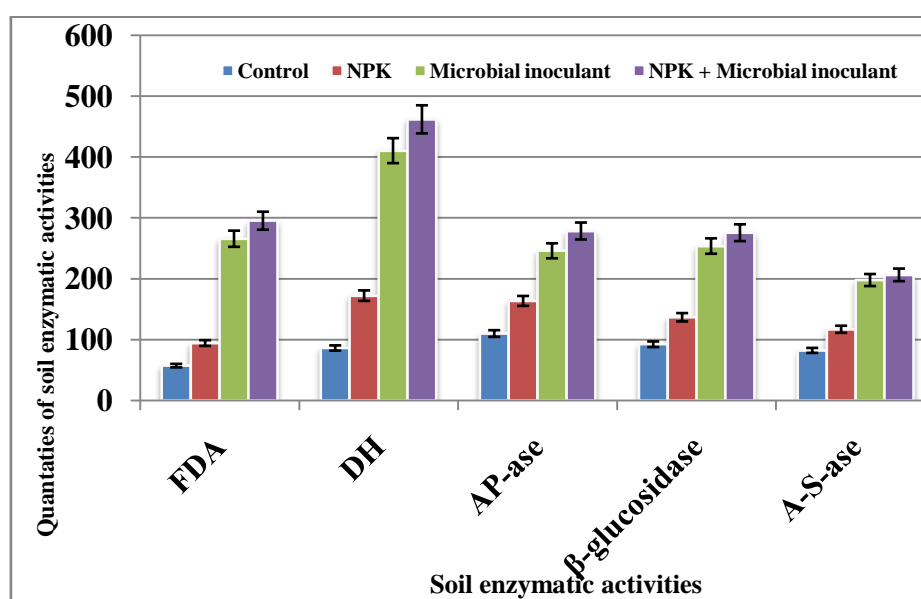

Figure 3. Effect of combined microbial inoculant with or without NPK application on potential enzymatic activities in clay loam brown forest rhizospheric soil of sunflowers

Zabihi et al. (2011) showed that activities such as production of ACC deaminase and IAA-like products, as well as phosphate solubilisation were among the most important activities of the tested *Pseudomonas* sp. Such bacterial effects greatly enhanced wheat growth and yield under greenhouse and field conditions. It has been indicated that the use of organic fertilization with chemical fertilization is a suitable method of providing crop plants with adequate amount of nutrients, while environmentally and economically appropriate. The role of PGPR, arbuscular mycorrhizal fungi, and endophytic bacteria is providing necessary nutrients for plant growth and yield production. Such microorganisms are beneficial to plant growth through colonizing plant roots and inducing mechanisms by which plant growth increases (Miransari, 2011). On the basis of present results, we can confirm the conclusions of Zabihi et al. (2011) and Miransari (2011).

Considering the good impact of PGPR in terms of biofertilization, biocontrol, and bioremediation, all of which exert a positive influence on crop productivity and ecosystem functioning, encouragement should be given to its implementation in agriculture. Hoping for the betterment of technology in developing successful research and development, PGPR use will surely become a reality and will be

instrumental to crucial processes that ensure the stability and productivity of agro-ecosystems, thus leading us towards an ideal agricultural system (Vejan et al., 2016).

Nanotechnology inclusion in the agricultural sector should be intensified to reduce the damages to the ecosystem and meet global crop demand. Over the past decades, promising results and applications have already been developed in the area of delivery of fertilizers, pesticides, and genetic material for plant transformation. Based on that, gigantic effort is needed to develop the aspect of nanotechnology with plant growth promoting bacteria. Finding the unique nanomaterials used to incorporate these mutualistic bacteria might prove to be a hard task but it is not impossible. Thus, nanotechnology has all the tools needed to improve the current biofertilizers used to support and uplift agricultural sustainability globally.

## CONCLUSIONS

The results showed that inoculation of rhizospheric soil with the characterized strains of *P. fluorescens*, *B. subtilis*, *S. cerevisiae* and *T. viride* achieved sunflower growth more than those achieved by full chemical fertilization without microbial inoculation, thus highlighting the potential of these strains for formulating new bioinoculants for sunflower yields.

Nevertheless, the novel observations described here represent main points forward in achieving the biotechnological challenging goal for increasing crop productivity by reducing its dependence on the agrochemicals throughout its natural growth. The future success of the biocontrol industry will benefit from interdisciplinary research, e.g., on mass production, formulation, interactions, and signalling with the environment, as well as on innovative business management, product marketing, and education. Altogether, the use of microorganisms and the exploitation of beneficial plant-microbe interactions offer promising and environmentally friendly strategies for conventional and organic agriculture worldwide.

Some of the most important functions of root-microbiomes were mentioned in this paper. However, the particular emphasis has been on the use of rhizospheric microbiomes including PGPR for biofertilization. However, there is important fact that the use of chemical fertilizers can adversely affect the soil environment. Here, it is important to mention that the contribution of chemical and biological fertilization to the plant growth. This can be used for the development of proper methods of fertilization. For the efficient development of biofertilizers the soil microbiomes must be properly selected, combined and formulated with respect to the present conditions.

An interesting and important point for the next research step is the combined use of soil microbiomes and chemical or/and organic fertilization such as compost or wastewater sludge to determine their appropriate rates of application to agricultural soil as well as the plant growth. This is of environmental and economic significance. There are several important key issues about this: a) the rhizospheric microbiomical potential for providing nutrients under certain conditions for plant utilization, b) plant type, c) soil properties, and d) climate properties.

The appropriate use of fertilization, which is a combination of chemical and biological fertilization can much contribute to the enhanced food production in the world, while economically and environmentally recommendable.

## REFERENCES

- Adesemoye, A., & Kloepper, J. (2009a). Plant-microbes interactions in enhanced fertilizer-use efficiency. *Applied Microbiology and Biotechnology*, Vol. 85, 1-12.
- Adesemoye, A. O., Torbert, H. A., & Kloepper, J. W. (2009b). Plant growth promoting rhizobacteria allow reduced application rates of chemical fertilizers. *Microbial Ecology*, Vol. 58, 921-929.
- Ambrosini, A., Beneduzi, A., Stefanski, T., Pinheiro, F. G., Vargas, L. K., & Passaglia, L. M. P. (2012). Screening of plant growth promoting rhizobacteria isolated from sunflower (*Helianthus annuus* L.). *Plant and Soil*, Vol. 356(1): 245-264.

- Bayoumi Hamuda, H. E. A. F., & Patkó, I. (2012). Root nodule bacteria and PGPR strains selection to improve inoculant performance and increase plant productivity in stressful soil. The 2nd Ed. the International Congress: Microbial Biotechnologies for Development (MICROBIOD 2). Topic I: Plant-Microorganisms Interactions, COI-13 pp: 65-66.
- Bhattacharyya, P. N., & Jha, D. K. (2012). Plant growth-promoting rhizobacteria (PGPR): emergence in agriculture. *World J. Microbiol. Biotechnol.*, Vol. 28, 1327-1350.
- Bremner, S. M. (1982). Total Nitrogen. In: Page A. L., Miller R. H. & Keeney D. R. (eds.) *Methods of Soil Analysis*, Part 2. ASA-SSSA Madison, USA, 595-624.
- Dodd, I. C., & Ruiz-Lozano, J. M. (2012). Microbial enhancement of crop resource use efficiency. *Curr Opin Biotechnol.*, Vol. 23, 236-242.
- Farina, R., Beneduzi, A., Ambrosini, A., de Campos, S. B., Lisboa, B. B., Wendisch, V., Vargas, K. L., & Passaglia, P. M. L. (2012). Diversity of plant growth-promoting rhizobacteria communities associated with the stages of canola growth. *Appl. Soil Ecol.*, Vol. 55: 44-52.
- García, C., Hernandez, T. & Cost, F. (1997). Potential use of dehydrogenase activity as an index of microbial activity in degraded soils. *Commun. Soil Sci. Plant Anal.*, Vol. 28, 123-134.
- Glick, B. R. (1995). The enhancement of plant growth by free-living bacteria. *Canadian Journal of Microbiology*, Vol. 41, 109-117. doi:10.1139/m95-015
- Glick, B. R. (2014). Bacteria with ACC deaminase can promote plant growth and help to feed the world. *Microbiological Research*, Vol. 169, 30-39. doi:10.1016/j.micres.2013.09.009
- Hayat, R., Ali, S., Amara, U., Khalid, R., & Ahmed, I. (2010). Soil beneficial bacteria and their role in plant growth promotion. *Ann. Microbiol.*, Vol. 60(4): 579-598.
- Lakshmanan, V., Castaneda, R., Rudrappa, T., & Bais, H. P. (2013). Root transcriptome analysis of *Arabidopsis thaliana* exposed to beneficial *Bacillus subtilis* FB17 rhizobacteria revealed genes for bacterial recruitment and plant defense independent of malate efflux. *Planta*, Vol. 238, 657-668.
- Ladeiro, B. (2012). Saline agriculture in the 21st century: Using salt contaminated resources to cope food requirements. *Journal of Botany*. doi:10.1155/2012/310705
- Miransari, M. (2011). Soil microbes and plant fertilization. *Appl. Microbiol. Biotechnol.*, Vol. 92(5): 875-85.
- Öhlinger, R. (1996). Biomass-C by Fumigation-Extraction Technique. In: Schinner, F., Kandeler, E., Öhlinger, R., & Margsin, R. (eds.) *Methods in Soil Biology*, Springer, Berlin, pp 54-56.
- Oliveira, C. A., Alves, V. M. C., Marriel, I. E., Gomes, E. A., Scotti, M. R., Carneiro, N. P., Guimaraes, C. T., Schaffert, R. E., & Sá, N. M. H. (2009). Phosphate solubilizing microorganisms isolated from rhizosphere of maize cultivated in an oxisol of the Brazilian Cerrado Biome. *Soil Biol. Biochem.*, Vol. 41, 1782-1787.
- Richardson, A. E., Barea, J.-M., McNeill, A. M., & Prigent-Combaret, C. (2009). Acquisition of phosphorus and nitrogen in the rhizosphere and plant growth promotion by microorganisms. *Plant and Soil*, Vol. 321, 305-339.
- de Santiago, A., García-López, A. M., Quintero, J. M., Avilés, M., & Delgado, A. (2013). Effect of *Trichoderma asperellum* strain T34 and glucose addition on iron nutrition in cucumber grown on calcareous soils. *Soil Biol. Biochem.*, Vol. 57, 598-605.
- de Souza, R., Beneduzi, A., Ambrosini, A., da Costa, B. P., Meyer, J., Vargas, K. L., Schoenfeld, R., & Passaglia, P. M. L. (2013). The effect of plant growth-promoting rhizobacteria on the growth of rice (*Oryza sativa* L.) cropped in southern Brazilian fields. *Plant and Soil*, Vol. 366 (1-2): 585-603.
- Schnürer, J., & Rosswall, T. (1982). Fluorescein diacetate hydrolysis as a measure of total microbial activity in soil and litter. *Appl. Environ. Microbiol.*, Vol. 43, 1256-1261.
- Tabatabai, M. A. & Bermned, J. M. (1969). Factors affecting soil aryl-sulphate activity. *Soil Sci. Soc. Am. Proc.*, Vol. 34, 427-429.
- Tabatabai, M. A. & Bermned, J. M. (1970). Use of P-nitrophenol phosphate in assay of soil phosphatase activity. *Soil Biol. Biochem.*, Vol. 1, 301-307.
- Vance, E. D., Brookes, F. C., & Jenkinson, D. S. (1987). An extraction method for measuring microbial biomass C. *Soil Biol. Biochem.*, Vol. 19: 703-707.
- Vejan, P., Abdullah, R., Khadiran, T., Ismail, S., & Boyce, N. A. (2016). Role of plant growth promoting rhizobacteria in agricultural sustainability. *Molecules*, Vol. 21, 573; doi:10.3390/molecules21050573.
- Vessey, J. K. (2003). Plant growth promoting rhizobacteria as biofertilizers. *Plant and Soil*, Vol. 255, 571-586. doi:10.1023/A:1026037216893
- Walkley, A., & Black, I. A. (1934). An examination of the Degtjareff method for determining soil organic matter, and a proposed modification of the chromic acid titration method. *Soil Sci.*, 37, 29-38.
- Zabihi, H. R., Savaghebi, G. R., Khavazi, K., Ganjali, A., & Miransari, M. (2011). Pseudomonas bacteria and phosphorous fertilization, affecting wheat (*Triticumaestivum* L.) yield and P uptake under greenhouse and field conditions. *Acta Physiologiae Plantarum*, Vol. 33 (1), 145-152.

V International Conference  
„ECOLOGY OF URBAN AREAS“ 2016

## ADSORPTION PROPERTIES OF MODIFIED FORMS OF ZEOLITE NH<sub>4</sub>NaY

Blagica Cekova<sup>1\*</sup>, Erhan Mustafa<sup>1</sup>, Viktorija Bezhovska<sup>2</sup>, Filip Jovanovski<sup>2</sup>

<sup>1</sup> MIT University, Faculty of ecological resources management 3rd Macedonian Brigade Boulevard,  
Skopje 1000, Republic of Macedonia

<sup>2</sup> University St. Cyril and Methodius, Skopje, Macedonia, Faculty of technology and metallurgy,  
Ruger Boskovic, 16, 1000 Skopje, Republic of Macedonia  
cekovab@yahoo.com

### ABSTRACT

Zeolites are three – dimensional crystalline compounds which are built from AlO<sub>4</sub> and SiO<sub>4</sub> tetrahedra. NH<sub>4</sub>NaY zeolite is obtained by ion exchange of NaY with aqueous solution of NH<sub>4</sub>Cl and belongs to a group phosposite zeolites. Their structure has D6R rings. It is Very solid and is therefore required to perform dealumination with organic acids. In our examinations also is used the commercial zeolite NH<sub>4</sub>NaY. For the determination of adsorption properties of the modified forms of NH<sub>4</sub>NaY is used static gravimetric method. For the examinations are taken NH<sub>4</sub>NaY modified forms of zeolite with 0,2 mol / dm<sup>3</sup> oxalic acid and hydrochloric acid 0,2 mol / dm<sup>3</sup> and citric acid. In the same conditions it was examined and commercial NH<sub>4</sub>NaY zeolite. Adsorption is done with steam. For the calculation of specific surface is used Langmuir's equation and the obtained results range from 29,9425 m<sup>2</sup> / kg 10<sup>3</sup> to 43,7819 m<sup>2</sup> / kg 10<sup>3</sup> in terms of commercial NH<sub>4</sub>NaY whose specific surface calculated in the same conditions is 33,3575 m<sup>2</sup> / kg 10<sup>3</sup>. The results are presented tabular and graphical with Langmuir's isotherms.

**Keywords:** Zeolite NH<sub>4</sub>NaY, adsorption, Langmuir's equation, modified forms, specific surface.

### INTRODUCTION

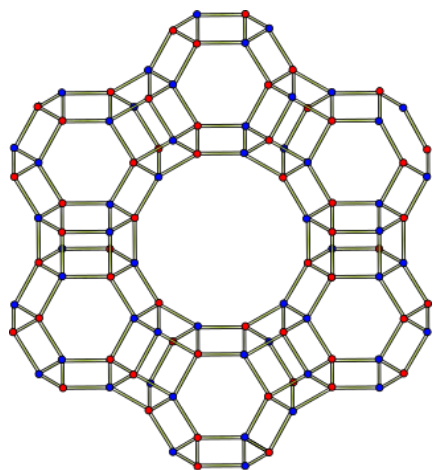

Figure 1. Zeolites structure

The zeolites are three dimensional sodium aluminium silicates. The zeolites with chemical formula NH<sub>4</sub>NaY are obtained from water solution of NH<sub>4</sub>Cl and NaY zeolites thus representing NH<sub>4</sub><sup>+</sup> form of NaY zeolite (Figure 1).

The crystal structure of the zeolites is built in tetrahedra forms as primary building unit where mainly the central atom is Si or Al surrounded by four oxygen atoms. The central atoms are interconnected with mutual oxygen atoms making oxygen bridges between them. That is the secondary structure unit.

The modified forms of NH<sub>4</sub>NaY are gained with dealumination of NH<sub>4</sub>NaY using organic acid (citric and oxalic) and mineral hydrochloric acid. (Breck, D. W. (1984).

Zeolite molecular sieves. Krieger Publ. Comp. Malabar, Florida)

### EXPERIMENTAL PART AND RESULTS DISCUSSION

For our examination samples are taken from modified forms of NH<sub>4</sub>NaY zeolite and the commercial available NH<sub>4</sub>NaY zeolite.

The adsorption has been made with water vapor using the static gravimetric method. The adsorption has been made in a thermostat at 25<sup>0</sup>C and water pressure of 3.1666 kPa and H<sub>2</sub>SO<sub>4</sub> concentrations of



70, 65 и 60 mass % . (B.CEKOVA: Adsorpcijska svojstva zeolita tipa 4A, Kem. Ind/ 38 (12) 577 – 580 (1989), M. M. Dubinin, Journal of Colloid and Interface Science 23 (1967) 487, 499)

The samples were measured every ten days.

The results are given in the tables 1,2 and 3 and the adsorption isotherm from Langmuir type are given in pictures 2,3 and 4 with linear forms of adsorption isotherm given in picture 5,6 and 7. (M. M. Dubinin, V. A. Aatanhov, Molecular Sieves Zeolites II, Adv. Shem. Ser. 102, Amer. Chem. Soc. Washington D. C. (69) 1971.)

Table 1.  $\text{NH}_4\text{NaY} + 0.2 \text{ mol/dm}^3$  citric acid

P (kPa)	P/a (kPa·kg/mol)	a (mol/kg)	am (mol/kg)	S ( $\text{m}^2/\text{kg} \cdot 10^3$ )
<b>0.1370</b>	0.0727	1.883	4.1428	29.9425
<b>0.2999</b>	0.1200	2.4990		
<b>0.5218</b>	0.1685	3.0969		

Table 2.  $\text{NH}_4\text{NaY} + 0.2 \text{ mol/dm}^3$  oxalic acid + 1 M p-p HCl

P (kPa)	P/a (kPa·kg/mol)	a (mol/kg)	am (mol/kg)	S ( $\text{m}^2/\text{kg} \cdot 10^3$ )
<b>0.1370</b>	0.0756	1.8111	6.0576	43.7819
<b>0.2999</b>	0.0851	3.5238		
<b>0.5218</b>	0.1400	3.7259		

Table 3. Commercial available  $\text{NH}_4\text{NaY}$  zeolit

P (kPa)	P/a (kPa·kg/mol)	a (mol/kg)	am (mol/kg)	S ( $\text{m}^2/\text{kg} \cdot 10^3$ )
<b>0.1370</b>	0.0533	2.5688	4.6153	33.3575
<b>0.2999</b>	0.0942	3.1818		
<b>0.5218</b>	0.1416	3.6838		

The specific area is calculated from the following equation:

$$S = a_m \cdot A_m \cdot 6.023 \cdot 10^3 \text{ (m}^2/\text{kg} \cdot 10^3\text{)} \quad (1)$$

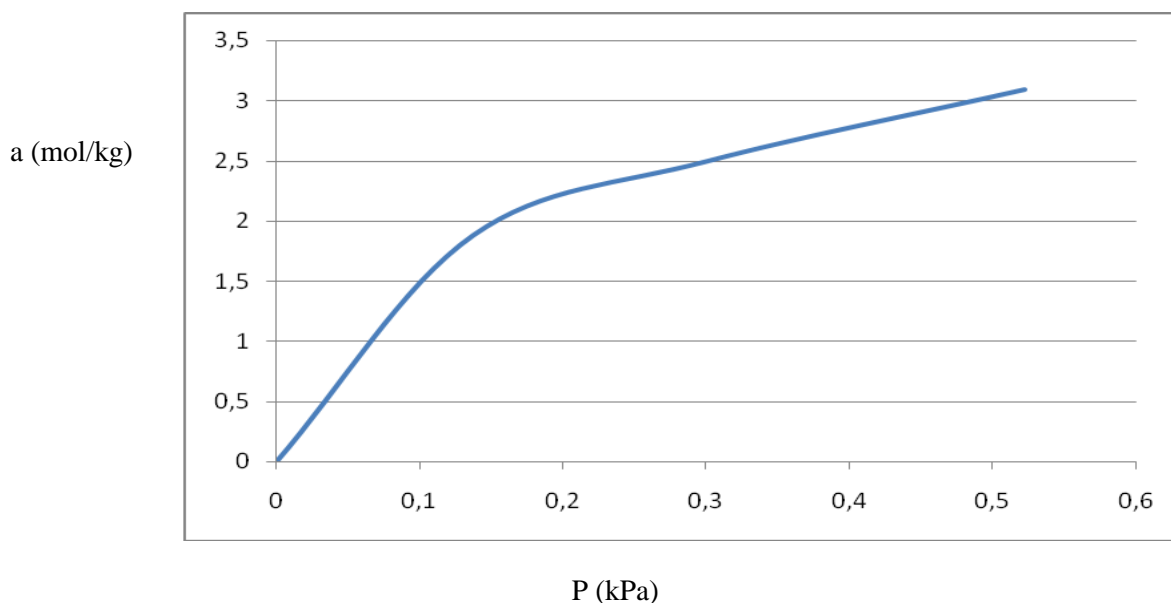

Figure 2. Adsorption isotherm of  $\text{NH}_4\text{NaY} + 0.2 \text{ mol/dm}^3$  citric acid

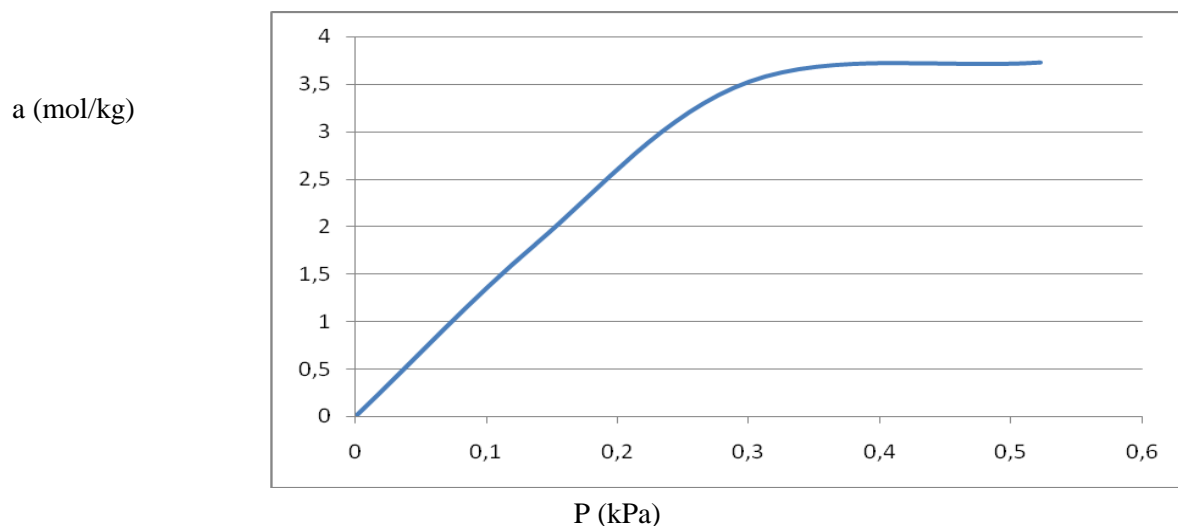

Figure 3. Adsorption isotherm of  $\text{NH}_4\text{NaY} + 0.2 \text{ mol/dm}^3$  oxalic acid + 1 M p-p HCl

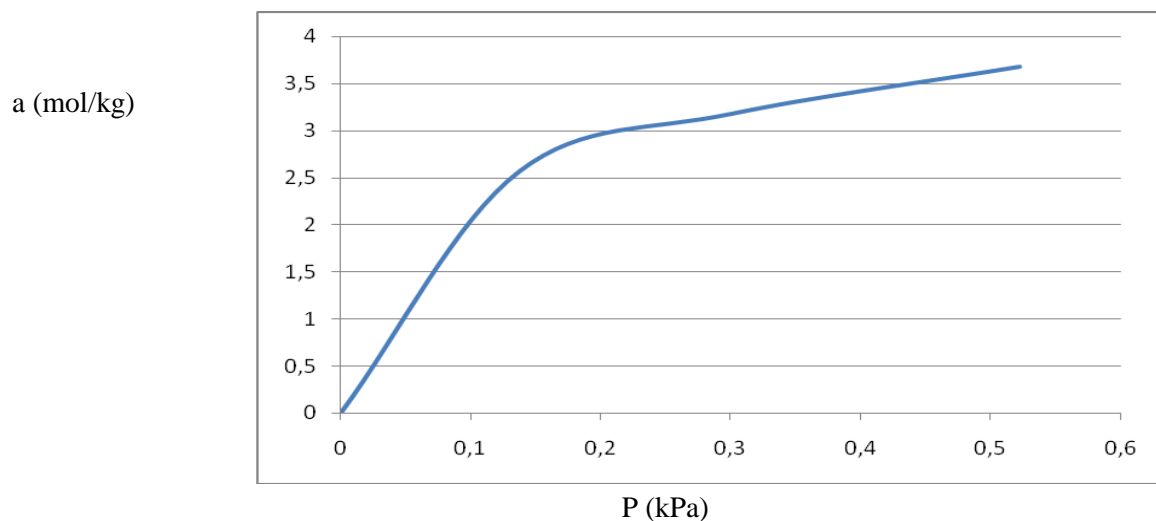

Figure 4. Adsorption isotherm of commercial  $\text{NH}_4\text{NaY}$  zeolit

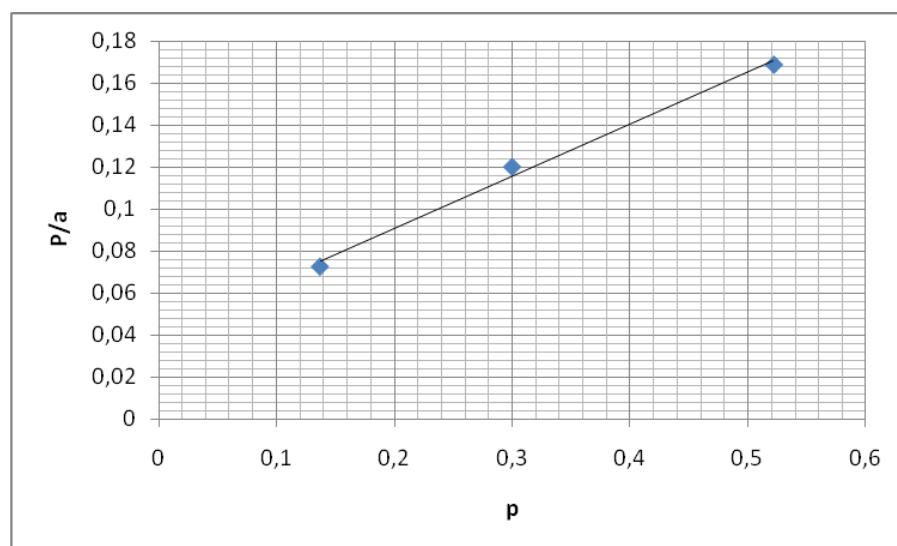

Figure 5. Linear forms of adsorption isotherm in Langmuir coordinates of  $\text{NH}_4\text{NaY} + 0.2 \text{ mol/dm}^3$  citric acid

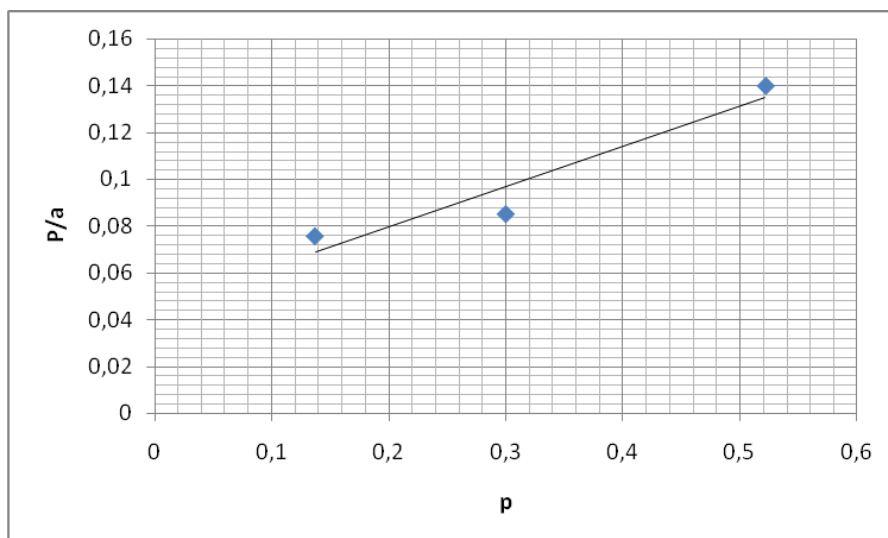

Figure 6. Linear forms of adsorption isotherm in Langmuir coordinates of  $NH_4NaY + 0.2 \text{ mol/dm}^3$  oxalic acid + 1 M p-p HCl

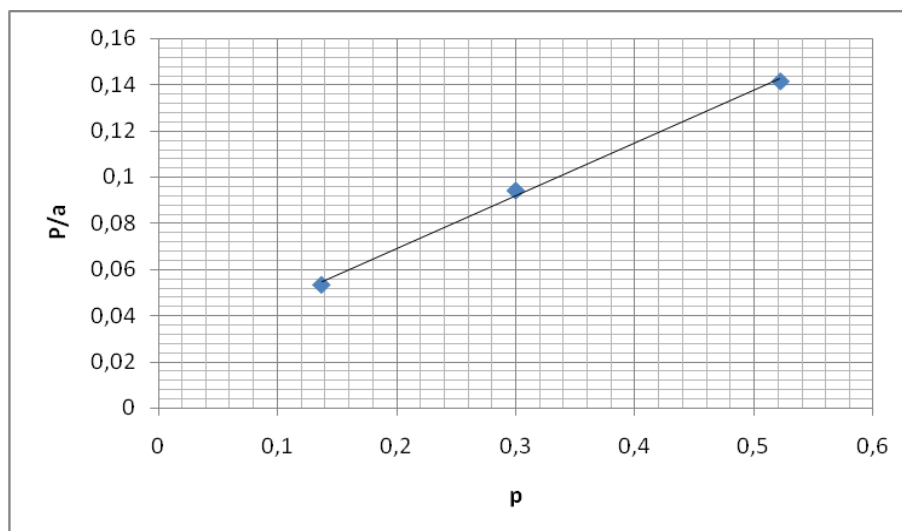

Figure 7. Linear forms of adsorption isotherm in Langmuir coordinates of commercial  $NH_4NaY$  zeolite

## CONCLUSION

With the carried examinations and the results we can make conclusion that the maximal determined specific area is  $43,7819 \text{ m}^2 / \text{kg } 10^3$  which can be connected to tight structure of the zeolite. The zeolites NaY and  $NH_4NaY$  are showing smaller adsorption properties and that's why they are dealuminated with organic and mineral acids. In contaminated soil and water they can be used as heavy metal adsorbents, however they are mostly used as catalysts in chemical reactions.

## REFERENCES

- B. CEKOVA: Adsorpcijska svojstva zeolita tipa 4A, Kem. Ind/ 38 (12) 577 – 580 (1989)  
 M. M. Dubinin, Journal of Colloid and Interface Science 23 (1967) 487, 499  
 M. M. Dubinin, V. A. Aatantov, Molecular Sieves Zeolites II, Adv. Chem. Ser. 102, Amer. Chem. Soc. Washington D. C. (69) 1971.  
 Breck, D. W. (1984). Zeolite molecular sieves. Krieger Publ. Comp. Malabar, Florida

V International Conference  
„ECOLOGY OF URBAN AREAS“ 2016

**LAND USE ANALYSES OF BUILT UP AREAS IN THE 19-20<sup>TH</sup>  
CENTURIES IN THE GÖDÖLLŐ HILLSIDE, HUNGARY**

**Krisztina Demény**

Óbuda University, Rejtő Sándor Faculty of Light industry and Environmental Protection Engineering, Institute of Environmental Protection Engineering, Budapest, Hungary  
demeny.krisztina@rkk.uni-obuda.hu

**ABSTRACT**

*In the last 200 years, the landscape gradually changed in Hungary. The study analysed former military, historical maps 1770s until 1890s and later EOV (Maps of the Unified National Mapping System) and CORINE Land Cover maps. The experimental analysis observed the transition direction of aerial distribution of various land uses with prepared land cover maps. Former surveys showed relevant changes in some type of land uses (e.g. arable lands, meadows and pastures). The main objective of this research work was focused on only built up areas, because due to the urbanization processes, and also, it was found that the great transformation in its distribution. Although, the second research point was to survey which type of land uses transformed to build up area. The increase of urban population and the prosperity of regional economy were the major driving forces of built-up area expansion. The study indicated that alterations were urgently needed in land management system and high-efficiency use of agricultural land. Promoting the compact development of built-up area was also crucial for striving toward regional sustainability.*

**Key words:** *land use, urbanization, historical maps.*

**INTRODUCTION**

The Gödöllő Hillside is situated close the capital; it is rich both in nature and landscape values. It belongs to the Northern Mountain Ranges macro region according to the micro-region classification. The area of Gödöllő Hillside is 550 km<sup>2</sup>, and it consists of 16 settlements. The landscape varies between 130 and 344 m above sea level, which reduces towards the south-east (Marosi and Somogyi 1990). The highest point of the hillside is Margita (344 m) which is situated near the village of Szada, located in a suburban region, and the lowest point is near to Gyömrő (130 m). It is a diverse micro-region with twofold natural characteristics. Due to its landscape characteristics, the micro-region is a transitory area between a plain terrain and medium-height mountain ranges from the aspect of geological, climatic, botanical and soil features. Besides the natural conditions, the land use in the micro-region is determined by its role in the country's economy, good accessibility and ecological conditions. The change in land use happened in parallel with the transformations in the population number (Berényi 1977).

This analysis focuses on four inner settlements of Gödöllő Hillside (Veresegyház, Szada, Gödöllő, Isaszeg), where significant changes happened in the studied period. This present survey is concentrated on only built up areas, because due to the urbanization processes I found great transformation in distribution of different landscape types, mainly in the ratio of built up and arable land areas. In my previous study I have dealt with arable lands (Demény 2015) and now changes in built up areas more detailed.

The Hungarian literature in the past decades several review studies were written about the Gödöllő Hillside. These studies are presented the topography, geological, climatological, hydrological, botanical, pedological features of the area and of course there are some were showed suburbanization changes in the agglomeration in Budapest (Marosi and Somogyi 1990, Péterfi, 1935, Láng 1967, Szabó and Szermek 1992, Dövényi et al. 1998, Dövényi 1999, Szabó and Tóthné Surányi 2003, Fekete 1965, Fekete and Varga 2006, Komárominé K. and Bardócyné Székely 2006). These overviews are

focus on the natural factors duality, which are basically between northern and southern part of the hillside. Similar research objectives have been investigated in various regions of Hungary (Szilassi et al. 2010, Penksza et al. 2007, Demény and Centeri 2008, Centeri et al. 2008, Vona et al. 2006), and in other countries as well (Digiovinazzo et al. 2011, Bieling et al. 2010, Liu et al. 2012, Xie et al. 2012).

## MATERIALS AND METHODS

Similar to my previous study for the analyses I used former military maps from 1770s until 1890s and later EOV and CORINE Land Cover Maps. Firstly I prepared land cover maps of the area. Secondly I separated different seven main land use categories (1. built up areas, 2. forests, 3. wetland areas, 4. meadows and pastures, 5. arable lands, 6. orchards and 7. vineyards). Finally I observed how and which directions changes the built up areas (I marked with “1”= changes areas or non-stable areas,” 0” = no changes or stable areas).

To the mapping I used following maps:

1. 1<sup>st</sup> (1763-1787) Military Survey Map (Scale=1:28,800) (Arcanum Ltd.)
2. 2<sup>nd</sup> (1806-1869) Military Survey Map (Scale = 1:28,800) (Arcanum Ltd.),
3. 3<sup>rd</sup> (1872-1885) Military Survey Map (Scale = 1:25,000) (Arcanum Ltd.),
4. Maps of the Unified National Mapping System (Scale = 1:10,000),
5. Corine Land Cover Maps of 2006 (Scale = 1:100,000).

## RESULTS AND DISCUSSIONS

The spatial structure of Gödöllő Hillside becomes more and more fragmented in the last 200 years. Parallel to an intensive land use and suburbanization processes have changed the proportion of built up areas. In the end of 18<sup>th</sup> century the area of 0.74% was inhabited, during the Ottoman rule the area was underpopulated. In the 19<sup>th</sup> century the proportion of built up areas increased but not tremendously (1.27%). To the end of 20<sup>th</sup> century population of the area was extremely increased (app. 20% in 2006).

### Transformation of between 1<sup>st</sup> and 2<sup>nd</sup> military Map

In this studied period (1763-1869) the share of stable areas in built up areas is more considerable than non-stable areas. 62.92% of built up areas weren't changed in this term. The main directions of changes are the following: 1<sup>st</sup> orchard (51.41%), 2<sup>nd</sup> forest (33.6%), 3<sup>rd</sup> wetland (10.17%). Surveyed in each settlement Gödöllő was where the highest transformation happened (Table1).

*Table1. Distribution of non-stable areas in built up areas in each settlement on 1<sup>st</sup> and 2<sup>nd</sup> Military Maps (1763-1869)*

Surveyed settlements	Non-stable areas (%)	Direction of changes (%)					
		Forest	Wetland	Pasture, meadow	Arable land	Orchard	Vineyard
<i>Veresegyház</i>	6.63	0.00	0.00	15.25	0.92	83.83	0.00
<i>Szada</i>	12.33	0.00	9.74	0.00	4.74	79.16	6.36
<i>Gödöllő</i>	66.82	50.29	13.34	0.97	0.00	35.40	0.00
<i>Isaszeg</i>	14.21	0.00	0.39	12.10	0.00	87.51	0.00

### Transformation of between 2<sup>nd</sup> and 3<sup>rd</sup> Military Map

During 19<sup>th</sup> century the built up areas weren't changed significantly in the Gödöllő Hillside, although in the four-centered settlements considerably reordering occurred. In this case, most part of built up areas were transformed (64.16%). The main directions of changes are the following: 1<sup>st</sup> pasture and

meadow, 2<sup>nd</sup> orchard, 3<sup>rd</sup> forest. In that case the southeast town, Isaszeg where 48.02% of built up areas were changed (Table2).

Table2. Distribution of non-stable areas in built up areas in each settlement on 2<sup>nd</sup> and 2<sup>rd</sup> Military Maps (1869-1885)

Surveyed settlements	Non-stable areas (%)	Direction of changes (%)					
		Forest	Wetland	Pasture, meadow	Arable land	Orchard	Vineyard
<i>Veresegyház</i>	15.21	0.00	0.36	2.43	3.56	93.65	0.00
<i>Szada</i>	8.30	0.00	0.00	0.04	1.01	98.94	0.00
<i>Gödöllő</i>	28.46	38.53	3.65	20.21	11.82	24.85	0.95
<i>Isaszeg</i>	48.02	10.97	1.28	86.41	0.29	1.05	0.00

### Transformation of between 3<sup>rd</sup> Military Map and EO V MAP

In the next studied period the share of built up areas was increased. Its maximum coverage was 13.78% at the end of 20<sup>th</sup> century. The rate of changeable and non-changeable territories is app. similar, share of stable areas are 54.99% and non-stable areas are 45.01%. The main directions of changes are the following: 1<sup>st</sup> orchard, 2<sup>nd</sup> pasture and meadow, 3<sup>rd</sup> arable land. Out of four centered towns Gödöllő and Veresegyház where one-third of the built up areas transformed (Table3).

Table3. Distribution of non-stable areas in built up areas in each settlement on 3<sup>rd</sup> Military Map and EO V Map (1885-1990)

Surveyed settlements	Non-stable areas (%)	Direction of changes (%)						
		Forest	Wetland	Pasture, meadow	Arable land	Orchard	Vineyard	Other land
<i>Veresegyház</i>	26.11	1.37	0.44	7.21	12.09	34.85	2.37	41.68
<i>Szada</i>	22.64	7.81	2.89	9.71	1.27	56.85	12.33	9.13
<i>Gödöllő</i>	33.73	5.33	10.87	30.58	8.12	40.67	2.03	2.40
<i>Isaszeg</i>	17.51	16.49	0.00	16.90	55.59	11.02	0.00	0.00

### Transformation of between EO V and Corine Land Cover Map

In the last analyzed term (in the end of 20<sup>th</sup> century) the coverage of built up areas were continuously increased. However the share of stable built up areas were more significant (78.65%) than non-stable built up areas (21.35%). The main directions of changes are the following: 1<sup>st</sup> other land (i.e. other agricultural land, other semi-nature land) (77.87%), 2<sup>nd</sup> forest (14.12%), 3<sup>rd</sup> arable land (6.4%). Gödöllő is a city where the transformation is considerable (Table4).

Table 4. Distribution of non-stable areas in built up areas in each settlement on EOVS Map and Corine Land Cover Map (1990-2006)

Surveyed settlements	Non-stable areas (%)	Direction of changes (%)						
		Forest	Wetland	Pasture, meadow	Arable land	Orchard	Vineyard	Other land
Veresegyház	3.68	34.87	9.70	0.18	17.06	0.00	0.00	38.19
Szada	30.80	4.27	0.00	0.00	2.66	0.00	0.00	93.07
Gödöllő	48.07	21.14	1.45	0.00	6.03	0.00	0.00	71.38
Isaszeg	17.46	7.78	3.14	0.00	11.80	0.00	0.00	77.29

From different cultivation forms in each settlement other land type (i.e. other agricultural land, other semi-nature land) is determinate.

## CONCLUSION

In the Gödöllő Hillside, more precisely in the four chosen settlements the land use forms has been transformed. Spatial structure has become fragmented, which is clearly indicated increasing in the number of polygons. The most dominated land use forms in the Gödöllő Hillside were forest, arable land and at the end of 20<sup>th</sup> century were built up areas. The main directions of transformations were orchards, pasture and meadows, again orchards, and other lands. The transformation was not only due to physical characteristics of the area but suburbanization and economic processes, too (expansion of settlements).

## REFERENCES

- Berényi, I. (1977): A földhasznosítás átalakulása és ennek környezetvédelmi kérdései a Gödöllő-Monori-dombságon. *Földrajzi Értesítő*, 26 (3-4): 337–348.
- Bieling, C., Allgaier, M., Hochtl, F. (2010): Beyond agricultural production: forest expansion and the preservation of open landscapes in marginal areas. A case study from the Black Forest, Germany. *Outlook Agric.* 39, 1: 25–30.
- Centeri, Cs., Vona, M., Vona, V., Szentes, S., Pető, Á., Bucsí, T., Penksza, K. (2008): Tracking the signs of recent geomorphological processes in the landscape in Hungary. *Bulletin of the Geological Society of Greece*, 42, 2: 7–13.
- Demény, K., Centeri, C. (2008): Habitat loss, soil and vegetation degradation by land use change in the Gödöllő Hillside, Hungary. *Cereal Res. Commun.*, Suppl. 36, 1739–1742.
- Demény, K. (2015). Changes of land uses in arable lands in the 19-20th century in the Gödöllő Hillside, Hungary. *Óbuda University e-Bulletin*, 5 (1): 41–47.
- Digiovino, P., Ficetola, G.F., Bottoni, L., Padoa-Schioppa, E. (2011): Scenarios to reduce forest fragmentation and improve landscape multifunctionality: a study from northern Italy. *Carpathian Journal of Earth and Environmental Sciences*, 6, 1, 23–34.
- Dövényi Z., Kok H, Kovács Z. 1998: A szuburbanizáció, a lokális társadalom és a helyi önkormányzati politika összefüggései a Budapesti agglomerációban. In: Illés S.-Tóth P. P. (szerk.) Migráció (tanulmánygyűjtemény) I. kötet: KSH Népeségstudományi Kutató Intézet, Budapest, 229-237.
- Dövényi Z., Kovács Z. 1999: A szuburbanizáció térbeni-társadalmi jellemzői Budapest környékén. *Földrajzi Értesítő* XLVIII évf. 1-2 füzet: 33-57.
- Fekete, G. (1965): Forested vegetation of the Gödöllő Hillside (in Hungarian with English abstract). Akadémiai Kiadó, Budapest.
- Fekete, G., Varga, Z. (ed.) (2006): Magyarország tájainak növényzete és állatvilága. MTA Társadalomkutató Központ, Budapest
- Komárominé K. M., Bardóczyné Sz., E. (2006): Applicability of the field research methods of landscape ecology and hidrology at Gödöllő-Isaszeg lake system on Rákos stream (methodological matters) (in Hungarian with English abstract). *Tájökológiai Lapok*, 4, 2: 249-253.
- Láng, S. (1967): A Cserhát természeti földrajza. Akadémiai Kiadó, Budapest
- Liu, D., Qe, R., Zhao, C., Liu, A. & Deng, X. (2012): Landscape ecological risk assessment in Yellow River Delta. *Journal of Food, Agriculture and Environment* 10 (2): 970-972.

- Marosi, S., Somogyi, S. (1990): Magyarország kistájainak katasztere II. MTA Földrajztudományi Kutató Intézet, Budapest. 802-806.
- Penksza, K., Centeri, C., Vona, M., Malatinszky, Á., Szentes, S., Balogh, Á., Pottyondy, Á., Szemán, L. (2007): The effects and environmental aspects of grasslands use change on plant-soil-erosion relations in Hungary. *Lucrări Științifice, Seria I.* 9, 2, 375–380.
- Péterfi, E. (1935): Geography of Gödöllő. Kertész József Könyvnyomdája, Budapest
- Szabó, L., Szermek, Zs.(1992): Evaluation of factors effecting soil loss in the northern agricultural areas of the Gödöllő Hillside (in Hungarian with English abstract). *Agrokémia és Talajtan* 41, 3-4, 203-213.
- Szabó, L., Tóthné Surányi, K. (2003): Geographical features of the Gödöllői-Monori Hillside and its soil protection (in Hungarian). In: Csorba, P. (ed) Environmental Protection Mosaics, for the 60<sup>th</sup> birthday of Dr. Attila Kerényi. University of Debreceni, 230–242.
- Szilassi, P., Jordan, Gy., Kovacs, F., Van Rompaey, A., Van Dessel, W. (2010): Investigating the link between soil quality and agricultural land use change. a case study in the lake Balaton catchment, Hungary. *Carpathian Journal of Earth and Environmental Sciences* 5, 2, 61–70.
- Vona M., Helfrich T. Centeri Cs. (2006): A Galgahévízi láprét felszínborítási viszonyainak változása légifotó elemzések alapján. *Tájökológiai Lapok* 4 (2). pp. 407-417.
- Xie, H., Wang, P. & Huang, H. (2012): Ecological risk assessment of regional land use change in Poyang Lake eco-economic region, China. *Interantional Jornal Enviroment. Resarch and Public Health* 9.



V International Conference  
“ECOLOGY OF URBAN AREAS” 2016

## HEAVY METALS IN AGRICULTURAL SOIL

Gordana Ludajić<sup>1\*</sup>, Lato Pezo<sup>2</sup>, Jelena Filipović<sup>3</sup>, Jelena Kiurski-Milošević<sup>1</sup>, Aleksandra Šućurović<sup>1</sup>

<sup>1</sup>Technical College of Applied Sciences in Zrenjanin, Zrenjanin, Serbia

<sup>2</sup>University of Belgrade, Institute of General and Physical Chemistry, Belgrade, Serbia

<sup>3</sup>University of Novi Sad, Institute for Food Technology, Novi Sad, Serbia

\*<sup>1</sup>gludajic@gmail.com, <sup>2</sup>latopezo@yahoo.co.uk, <sup>3</sup>jelena.filipovic@fins.uns.ac.rs, <sup>1</sup>jelena.kiurski@gmail.com, <sup>1</sup>aleksandrasucurovic@gmail.com

### ABSTRACT

*The present research was conducted to study heavy metals contamination in roadside soils of Banat and Bačka in the Vojvodina Province, the northern part of Serbia. Roadside soil samples were collected from 10 sites and analysed for heavy metals Pb, Cd, Hg, As, Zn, Cu, Fe and Mn. Inductively Coupled Plasma Mass Spectrometry was used for analysis. The mean total content in soil: 17.398 mg/kg for Pb, 0.164 mg/kg for Cd, 0.012 mg/kg for Hg, 10.696 mg/kg for As, 24214.038 mg/kg for Fe, 592.396 mg/kg for Mn and 58.574 mg/kg for Zn. Correlation analysis, ANOVA and F-test were applied for statistical evaluation of obtained results. The calculated mean and median levels of contamination were compared with the recommended or regulated maximum levels, according to the European Commission and the national legislation.*

**Keywords:** roadside soils, heavy metals, contamination, ICP mass spectrometry.

### INTRODUCTION

Soil is one of the most important natural resources, an invaluable treasure which is slow to form, but fast to devastate in a destruction process. The pollution of soils by heavy metals from automobile sources is a serious environmental issue. Most of heavy metals are emitted from anthropogenic sources (Dolan et al., 2006).

Industry, transport, manure and herbicides used in agronomy, industrial wastes as well as sewage silt causes an environmental hazard of polluting plants, animals and people with heavy metals (Fargasova, 1999).

Pollutants enter the soil from many sources. The substances containing heavy metals (HMs) are among the most important. As a result, soil pollution may be caused by Cd that enters soil through phosphorous fertilizers. Irrigation with water polluted with heavy metals may also lead to soil pollution (Muchuweti et al., 2006). In intensively farmed areas, agricultural development is also accompanied by the use of large amounts of pesticides and organic and inorganic fertilizer inputs. Increased use of chemical fertilizers and livestock and poultry manure can also lead to an increase in heavy metals such as Cd, Pb, Cu, and Zn in soils and plants (He et al., 2005).

The majority of the heavy metals is toxic to the living organisms and even those considered as essential can be toxic if present in excess. The heavy metals can impair important biochemical processes posing a threat to human health, plant growth and animal life (Jarup, 2003; Michalke, 2003; Silva et al., 2005).

The soil of Banat and Bačka is an exceptional farming area from the point of view of its natural potential. Soil monitoring is required in order to safeguard this vital resource and to ensure the production of healthy food and high and stable yield (Ludajić, 2014).

The objective of this research was to investigate the presence of heavy metals (Pb, Cd, Hg, As, Zn, Cu, Fe and Mn) in selected agricultural soils in Banat and Bačka. The results of the investigation will

provide information on the possibility of growing crops in soils close to roads and on reducing the harmful effects of pollutants released from fuel burning on the soil.

## **MATERIAL AND METHODS**

### **Material**

An average soil sample was taken from ten selected parcels, in Banat Perlez, Elemir, Melenci, Kumane, Novi Bečej, Kikinda, Banatski Monoštor, Čoka) and Bačka (Senta, Tornjoš). The average soil samples were taken at three points, each at a different distance from the road (at 0, 100 and 200 m from the road).

Ten soil samples were taken from each point and mixed together to make a composite sample representative of that part of a particular site. Samples were taken in the same way from each site, so a total of 30 composite soil samples were collected and analysed.

### **Soil sampling techniques and analytical methods**

Metal contents in the soils were analysed after a microwave assisted digestion of the samples (Luo et al., 2007) using a multiwave 3000 microwave oven. The procedure was based on 3051A (US EPA, 1998). The aliquot of 0.5 g of each sample was measured and then digested with a mix of 9 ml of HNO<sub>3</sub> and 3 ml of HCl. As recommended by the US EPA Method 3051A, the temperature of the samples was raised to 170 °C in less than 5.5 min and remained between 170 and 180 °C for the balance of the 10 min irradiation period. After digestion, the solutions were filtered through Whatman No. 1 filter papers, and the volumes were adjusted to 50 ml using double deionized water (18.2 Ω). The concentrations of Pb, Cd, As, Hg, Zn, Cu, Fe and Mn were measured using inductively coupled plasma mass spectrometry (Elan 9000, ICP-MS).

### **Statistical analysis**

Descriptive statistical analyses for calculating the means and the standard error of the mean were performed using the StatSoft Statistica 10 software. All the results obtained were expressed as the mean ± standard deviation (SD). The evaluation of the correlation matrix, one-way analysis of variance (ANOVA), and F-test and PCA analysis of obtained results were performed using StatSoft Statistica 10 software.

## **RESULTS AND DISCUSSION**

The maximum allowed concentrations of some elements in the soil according to the Regulation on the maximum levels of dangerous and harmful substances found in soil and irrigation water and methods of their testing (Serbian Regulations, 1994) are shown in Table 1.

The content of lead in the soil samples in all tested localities, regardless of the distance from the road (Table 2) is far below the maximum allowed concentration. The highest content of lead was found in the locality of Kikinda (22.205 mg/kg), which accounts for the fact that the soil sample was taken from a site that was alongside roads with heavy traffic flow on the one hand, and the fact that the site was near an industrial zone on the other hand (Ludajić et al., 2015). The average lead content found in all the analysed soil samples was 17.389 mg/kg, which implies that the analysed soils were not lead contaminated since the permitted quantity of lead was 100 mg/kg (Table 1).

*Table 1: The maximum allowed concentrations of some elements in soil*

Elements	MAC in soil mg/kg of soil
Cadmium	3
Lead	100
Mercury	2
Arsenic	25
Copper	100
Zinc	300

ANOVA was also calculated together with the F test for HMs content in soil. According to the F test comparison between effects, Mn content ( $F = 78640.0$ ) was found to be the more influential variable for the final result, than Zn ( $F = 2885.4$ ) or Fe ( $F = 2699.02$ ), significant at  $p < 0.01$  level, 95 % confidence limit.

According to Brankov et al. (2006), Zn in soil originates from the parent substrate. Mineral fertilizers rarely contain more than 100 mg/kg of copper and their long application in field experiments did not cause copper contamination of the soil. The copper content in the roadside soils ranged from 13.94 to 31.60 mg/g with the mean value of 21.93 mg/g (Table 2).

*Table 2: Descriptive statistics data for toxic element and essential microelements content (mg/kg) in soil*

	Distance	Heavy metals							
		Pb	Cd	Hg	As	Zn	Cu	Fe	Mn
Mean	0m	17.43	0.17	0.01	10.49	59.16	21.93	24612.74	593.32
SD	0m	3.60	0.01	0.00	1.68	14.57	5.01	3870.28	91.86
Min.	0m	11.21	0.14	0.01	7.04	37.57	13.94	18088.25	417.83
Max.	0m	22.21	0.18	0.02	13.04	80.33	31.60	31584.75	748.45
Mean	100m	16.39	0.16	0.01	10.34	57.35	21.43	23852.46	586.05
SD	100m	3.40	0.01	0.00	1.62	14.28	4.68	3845.66	93.11
Min.	100m	10.85	0.13	0.01	7.02	35.46	13.78	18040.63	411.49
Max.	100m	21.12	0.17	0.01	13.04	78.74	29.87	30780.13	742.70
Mean	200m	15.57	0.16	0.01	10.10	55.62	21.08	23645.76	583.48
SD	200m	3.66	0.01	0.00	1.62	13.40	4.71	3886.91	93.26
Min.	200m	10.05	0.13	0.01	6.93	34.86	13.54	18009.13	410.74
Max.	200m	21.29	0.17	0.01	12.94	74.74	29.93	30579.00	741.84

Statistically significant correlations between the content of analysed elements in soil samples at different distances from the road, were recorded between essential trace elements Zn, Cu, Fe and Mn at the level of  $p < 0.01$  (Table 3).

A statistically significant correlations (at  $p < 0.01$  level) between Cd content and all other mineral contents were observed, Hg ( $r = 0.209$ ), As ( $r = 0.360$ ), Zn ( $r = 0.565$ ), Cu ( $r = 0.526$ ), Fe ( $r = 0.786$ ), and Mn ( $r = 0.690$ ).

Table 3: The Pearson correlation coefficients between HM assays in soil samples (0, 100 and 200 m from the road), with statistical significance expressed as p-level values, written in small parentheses

	Cd	Hg	As	Zn	Cu	Fe	Mn
Pb	0.586 <sup>+</sup>	0.033	0.569 <sup>+</sup>	0.846 <sup>+</sup>	0.853 <sup>+</sup>	0.661 <sup>+</sup>	0.762 <sup>+</sup>
Cd		0.209 <sup>+</sup>	0.360 <sup>+</sup>	0.565 <sup>+</sup>	0.526 <sup>+</sup>	0.786 <sup>+</sup>	0.690 <sup>+</sup>
Hg			0.003	0.158 <sup>*</sup>	0.089	0.084	0.140 <sup>*</sup>
As				0.453 <sup>+</sup>	0.454 <sup>+</sup>	0.529 <sup>+</sup>	0.515 <sup>+</sup>
Zn					0.952 <sup>+</sup>	0.456 <sup>+</sup>	0.810 <sup>+</sup>
Cu						0.391 <sup>+</sup>	0.844 <sup>+</sup>
Fe							0.493 <sup>+</sup>

<sup>+</sup>Significant at p<0.01 level; <sup>\*</sup> significant at p<0.05 level; <sup>\*\*</sup> significant at p<0.10 level

Quality results show that the first two principal components, accounting for 100% of the total variance. Considering the map of the PCA performed on the data, the negative scores to first principle component calculation was observed by all variables (which contributed an almost identical amount of the total variance, between 13.0-14.8%, based on correlations). The second principal component was influenced negatively by As content (30.5% based on correlations) and positively influenced by Cd (44.2%). PCA graphics showed quite good discrimination between samples of soil. The influence of heavy metal contents can be observed in Fig. 1, in which the most polluted site is observed in the left part of the chart (with the zero distance from the highway), while the site furthest from the highway is the least polluted (200m from the highway).

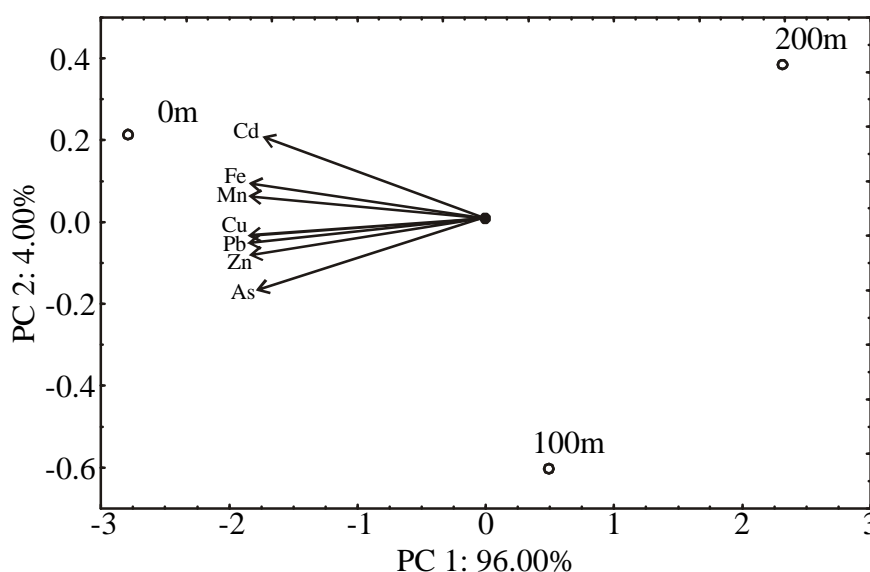

Figure 1. Biplot graphic of the heavy metal contents in agricultural soil

## CONCLUSION

Considering the results of the analysis of toxic element content in wheat and soil, it could be concluded that:

- The content of lead in the soil samples in all tested localities, regardless of the distance from the road is far below the maximum allowed concentration.
- The average lead content found in the analysed soil samples was 17.389 mg/kg
- The level of Pb concentration in wheat samples taken from the sites alongside the roads is higher than the level prescribed in the EU regulations.

- According to ANOVA and F-test at  $p < 0.01$  level, 95% confidence limit used for element content analysis in soil, it was found that Mn content ( $F=78640.0$ ) was a more influential variable for the final result, followed by Zn ( $F=2885.4$ ) or Fe ( $F=2699.02$ ).
- The soil of Banat and Bačka is an exceptional farming area from the point of view of its natural potential, so monitoring of the land quality is required in order to preserve this natural treasure, i.e. production of healthy food and obtaining high and stable yield.

## REFERENCES

- Dolan, L. M. J., Van Bohemen, H., Whelan, P., Akbar, K. F., O'Malley, V., O'Leary, G., & Keizer, P. J. (2006). Towards the sustainable development of modern road ecosystem. In: Davenport J., Davenport J. L. (eds). *The Ecology of Transportation: Managing Mobility for the Environment*. Springer Netherlands, 275–331.
- Fargasova, A., (1999). Root growth inhibition, photosynthetic pigments production, and metal accumulation in *Sinapis alba* as the parameters for trace metals of effect determination. *Bulletin of Environmental Contamination and Toxicology*, 61, 762-769.
- He, Z. L. L., Yang, X. E., & Stoffella, P. J. (2005). Trace elements in agroecosystems and impacts on the environment. *Journal of Trace Elements in Medicine and Biology*, 19, 125-140.
- Jarup, L. (2003). Hazards of heavy metal contamination. *Brazilian Medical Bulletin*, 68: 425–462.
- Ludajić, G. (2014). The impact of motorway proximity on microelements content in wheat and agricultural land. *Ph.D. Thesis*, University of Novi Sad, Faculty of technology.
- Ludajić, G., Pezo, L., Filipović, N., & Filipović, J. (2015). A chemometric approach to study the effects of motorway proximity on microelements content in wheat and soil. *International Journal of Environmental Science and Technology*, 12, 2639-2648.
- Luo, W., Wang, T., Lu, Y., Giesy, J.P., Shi, Y., Zheng, Y., Xing, Y., & Wu, G. (2007). Landscape ecology of the Guanting Reservoir, Beijing, China: Multivariate and geostatistical analyses of metals in soils. *Environmental Pollution*, 146, 567–576.
- Michalke, B. (2003). Element speciation definitions, analytical methodology, and some examples. *Ecotoxicology and Environmental Safety*, 56: 122–139.
- Muchuweti, M., Birkett, J. W., Chinyanga, E., Zvauya, R., Scrimshaw, M. D., & Lester, J. N. (2006). Heavy metal content of vegetables irrigated with mixtures of wastewater and sewage sludge in Zimbabwe: Implications for human health. *Agriculture Ecosystems and Environment*, 112, 41-48.
- Regulation on the maximum levels of dangerous and harmful substances found in soil and irrigation water and methods of their testing (“Official Gazette of the Republic of Serbia” No.23/94).
- Silva, A. L. O., Barrocas, P. R. G., Jacob, S. C., & Moreira, J. C. (2005). Dietary intake and health effects of selected toxic elements. *Brazilian Journal of Plant Physiology*, 17: 79–93.
- Thornton, I. (1991). Metal contamination of soils in urban areas. In: Bullock, P., Gregory, P.J. (Eds.), *Soils in the Urban Environment*. Blackwell Publishing, 47–75.
- United States Environmental Protection Agency (US EPA). (1998). Method 3051A: Microwave Assisted Digestion of Sediments, Sludges, Soils and Oil (revision 1).

V International Conference  
„ECOLOGY OF URBAN AREAS“ 2016

**CONTAMINATION INDICES AND HEAVY METAL  
CONCENTRATIONS IN THE LEAVS OF PERENNIAL PLANT  
SPECIES IN THE URBAN ZONE OF SABAC, SERBIA**

**Mirjana Antonijević Nikolić\*, Kosana Popović, Dušan Stanojević**

Higher medical and business-technological school of professional studies,  
Hajduk Veljkova 10, 15000 Sabac, Serbia  
mirjanaantonijevic@vtssa.edu.rs

**ABSTRACT**

*Heavy metals are the substances that indicate environmental pollution. The plants polluted with heavy metals may endanger natural environment and cause health problems in humans. Environmental monitoring in urban zone of Sabac, Serbia was performed using plant samples. Sample preparation was carried out by dry digestion, burning and dissolving the ash the first in 6M HCl and then in 0.1 M HNO<sub>3</sub>. The analyses of selected heavy metals contents (Cd, Pb, Cu, Ni, Mn and Fe) in plants were performed by the method of atomic absorption spectroscopy. The obtained data were compared with the respective values from literature. In the analyzed samples metal content is in the range found for plant species from literature except where Ni is in some samples content exceeds the limit value. Also, the obtained results were compared to the contents of heavy metals in the soil from this area. Finally, the impact of some pollutant and composition of the soil was analyzed.*

**Key words:** heavy metals, plants, urban zone of Sabac.

**INTRODUCTION**

Heavy metals occur as natural constituents of the earth crust, and they can be difficult environmental pollutants since they cannot be degraded or destroyed. In rocks, they exist as their ores in different chemical forms, from which they are recovered as minerals. Natural and anthropogenic activities increase the concentration of these elements to amounts that are harmful to both plants and animals. Increasing industrialization and urbanization had anthropogenic contribution of heavy metals in environmental. Heavy metals, such as cadmium, copper, lead, chromium and mercury are major environmental pollutants of the air, water and soil.

Plants growing in metal-polluted sites exhibit altered metabolism, growth reduction, lower biomass production and metal accumulation.

This article details the range of heavy metals and their presence in selected plant (biota) samples by the method of atomic absorption spectroscopy. The plants through the root system adopted pollutants, including heavy metals, therefore, are good indicators of soil and environmental pollution. Environmental monitoring in urban zone of Sabac, Serbia was performed.

**THEORY**

Heavy metals are significant environmental pollutants, especially in areas with high anthropogenic activities. Toxicity of heavy metals is a problem of increasing importance for ecological, evolutionary, nutritional and environmental reasons. Heavy metals are naturally present in the soil. There are different sources of heavy metals in the environment such as natural sources, agricultural sources, industrial sources, domestic effluent, atmospheric sources and other sources (Nagajyoti et al., 2010). Heavy metals can be emitted in the environment from both natural and anthropogenic activities. Activities such as mining and smelting of metals, burning of fossil fuels, use of fertilizers and pesticides in agriculture, production of batteries and other metal products in industries, sewage sludge, and municipal waste disposal (Alloway, 1990; Raskin et al., 1994; Shen et al., 2002) increase the concentration of these elements to amounts that are harmful to both plants and animals.

Some heavy metals such as Cu, Zn, Fe, Mn, Mo, Ni and Co are essential micronutrients (Reeves and Baker, 2000) which are in small quantities necessary to plants. However, excessive amounts of these elements can result in toxic effects to plants. They are also called as trace elements due to their presence in trace (10 mg/kg, or mg/dm<sup>3</sup>) or in ultra trace (1 µg/kg, or µg/dm<sup>3</sup>) quantities in the environmental matrices (Nagajyoti et al., 2010). Other heavy metals such as Pb, Cd, Hg, and As do not have any beneficial effect on plants and are thus regarded as the “main threats” (Asati et al., 2016), since they are very harmful for plants and they are strongly poisonous to the metabolic activities.

Copper is an essential micronutrient for higher plants and algae, especially for photosynthesis (Mahmood and Islam, 2006). Excess of Cu in soil exerts a cytotoxic effect, induces stress and causes injury to plants, what leads to plant growth retardation and leaf chlorosis (Lewis et al., 2001). Different human activities including enhanced industrial and mining and smelting of Cu-containing ores have contributed to the increasing occurrence of Cu in environment. Two main anthropogenic sources that contaminate the soil are fly ash produced due to coal burning and the corrosion of commercial waste products, which add Cu into the environment (Nagajyoti et al., 2010). Also, metal emission during the transportation of vehicles includes Cu primarily from diesel engines (Nagajyoti et al., 2010).

Nickel is an essential micronutrient for plants. The amount of Ni required for normal growth of plants is very low. Excess of Ni in soil causes various physiological alterations and diverse toxicity symptoms (Zornoza et al., 1999; Pandey and Sharma 2002; Rahman et al., 2005). Nickel is a transition metal and found in natural soils at trace concentrations. Human activities such as mining works, emission of smelters, burning of coal and oil, sewage, phosphate fertilizers and pesticides (Nagajyoti et al., 2010) lead to increasing concentration Ni in environment.

Manganese is an essential micronutrient for plants and plays an important role in several physiological processes, especially photosynthesis. While suitable for smaller concentrations, at high has a negative impact. The high concentrations of manganese lead to accumulation of excessive manganese in leaves causing a reduction of photosynthetic rate (Kitao et al., 1997). A general symptom of Mn toxicity is necrotic brown spotting on leaves, petioles and stems (Wu, 1994).

Iron as an essential element for all plants has many important biological roles in the processes as diverse as photosynthesis, chloroplast development and chlorophyll biosynthesis. Iron and manganese both play an important role in plant growth and development, but often compete for absorption, as an abundance of one of these micronutrients makes the other less available to plant roots (Nagajyoti et al., 2010; Asati et al., 2016).

For metals Pb i Cd which do not play any beneficial role in plant growth, harmful effects have been recorded at very low concentrations of these metals in the growth medium. Lead is one of the most common toxic elements in the soil. Pb has damaging effect on morphology, growth and photosynthetic processes of plants (Nagajyoti et al., 2010; Asati et al., 2016). Plants grown in soil containing high levels of Cd show visible symptoms of damage which lead to death (Wojcik and Tukiendorf 2004; Mohanpuria et al. 2007).

Plants can absorb heavy metals from soil as well as from air. Differences in the adoption of heavy metals from the soil primarily depend on the genetic the constitution of the plant, and then the characteristics of the root system, its capacity for the absorption of ions and the levels of evapotranspiration (Obratov-Petković et al., 2008). As with soil, the capacity of plants to accumulate heavy metals is limited. Exceeding the content of heavy metals in soils, even in the case of essential elements, leading to phytotoxicity in the plant (Kadović et al., 2002). In the process of monitoring environmental pollution by heavy metals, more and more attention is dedicated to researching the heavy metals contents in plants.

## MATERIAL AND METHODS

### Sampling site

The city of Sabac is located in north-western Serbia. The geographical position of the municipality is very favorable because it is located on important traffic routes: road, rail and river, and near the big cities of Belgrade and Novi Sad. Sabac municipality covers an area of 795 km<sup>2</sup> and has 122,320 inhabitants. In the city and in the suburbs, has a population of 70 000 inhabitants. The industrial zone is located on a former chemical industry HI "Zorka", which exists today in the form of independent companies with similar activities. Its coordinates are: 44°45'20.88" N, 19°41'38.04" E. In this paper we environmental monitoring in urban zone of Sabac, was performed using plant samples from one park. Location of the park with the sampling points is given in Figure 1.

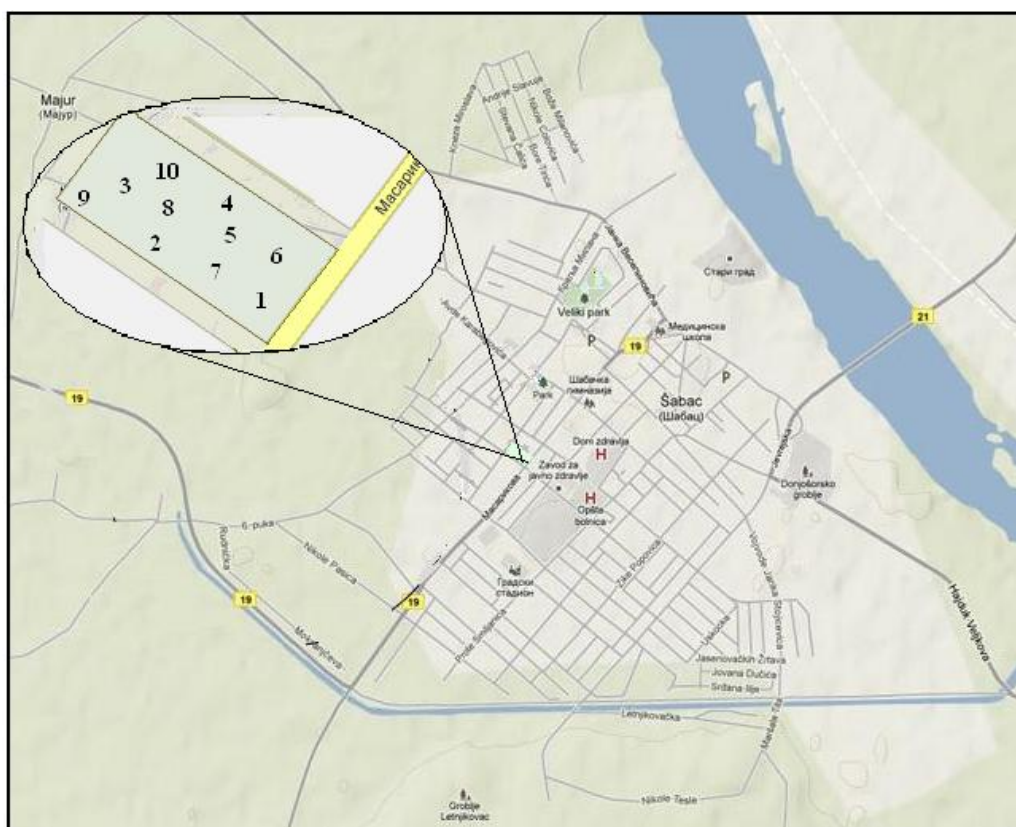

Picture 1. Location of the park with the sampling points

### Sampling procedure

A representative group of plant samples was taken in April-June, 2012. from a urban area of Sabac, Serbia. We selected three plant species for the analysis: *Acer Platanoides*, *Acer Pseudoplatanus* and *Liquidambar Styraciflna*.

For each species, only leaves were sampled and for that purpose about 1 kg of material was collected. Leaves of selected perennial plant were washed with deionized water, first dried at room temperature for seven days and then 12 hours at 50 °C. The samples were thoroughly ground, mixed and uniformed in order to obtain representative samples. They are used for laboratory analyses.

### Analytical procedure

Sample preparation was carried out by dry digestion. Dry samples leaves were used for digestion weighing about 3 g (measured on an analytical balance with accuracy to the fourth decimal) are



annealed in an annealing furnace for a gradual increase in temperature 50 °C/h from ambient to 450 °C, at which the sample held for 8 hours. Obtained ash was dissolved in 6M HCl (1:1, v/v), and then the solution was evaporated to dryness. The resulting precipitate was dissolved in 0.1M HNO<sub>3</sub>, filtered, washed with deionised water, and received in 50.0 cm<sup>3</sup> volumetric flasks (Perić-Grujić et al., 2009).

Heavy metals (Cd, Pb, Cu, Ni, Mn and Fe) concentrations were determined by atomic absorption (AAS) method, using a Perkin-Elmer spectrophotometer AAS-5100/PC.

## FINDING AND DISSCUSION

The concentration of heavy metals in the analyzed samples of the leaves is determined by atomic absorption spectroscopy. The results are expressed in mg of the respective metals /kg of dried plant material. Table 1 shows the concentration of the four elements in the studied plant.

Table 1. Heavy metals contents in plants

Plant species	Sam ple	Concentration mg/kg					
		Cu	Ni	Mn	Fe	Pb	Cd
<i>Acer Pseudoplatanus</i>	1.	7.41	2.47	32.12	115.28	< 2.5	< 0.07
<i>Acer Pseudoplatanus</i>	2.	8.90	2.43	41.29	110.10		
<i>Liquidambar Styraciflna</i>	3.	8.19	6.55	193.36	90.94		
<i>Acer Pseudoplatanus</i>	4.	9.93	1.65	40.13	114.18		
<i>Liquidambar Styraciflna</i>	5.	5.80	4.97	67.56	121.85		
<i>Acer Platanoides</i>	6.	4.93	3.29	25.49	115.95		
<i>Acer Platanoides</i>	7.	2.49	2.49	29.98	119.91		
<i>Acer Platanoides</i>	8.	6.63	4.97	46.86	116.11		
<i>Acer Platanoides</i>	9.	4.98	4.15	48.51	140.15		
<i>Acer Platanoides</i>	10.	11.60	2.48	58.44	144.25		
Element Concentration Cadasters in Ecosystems, Literature range (Obratov- Petković et al., 2008; Malenčić et al., 2003)		2-20	0.4-4	1-700	5-200	0.1-5	0.05-0.2

The copper content in the samples is from 2.49 to 11.60 mg/kg (Table 1). These values are in the range that was found for various plant species described in the literature (2-20 mg/kg) (Obratov-Petković et al., 2008, Malenčić et al., 2003). In previous analyzes of soil, we found contains of Cu in the ranged from 28.11 to 42.57 mg/kg. This is well below the limited value for copper recommended by the national standard (MDK), limited value is 100 mg/kg. (Antonijević-Nikolić et al., 2013).

The concentration of nickel in samples of leaves is given in Table 1. The values obtained are from 1.65 to 6.55 mg/kg. In the four samples (3, 5, 8 and 9), the obtained values were higher than given in literature. This indicates possible contamination of plants. Soil analysis in some samples the park was also showed higher values of Ni content (37.66-54.19 mg/kg) then values recommended by the national standard (50 mg/kg) (Antonijević-Nikolić et al., 2013).

A significant source of Ni in soil and plants is from atmospheric deposits. Emission Ni to the atmosphere is from the combustion of fuel and oil. Coal burning is a significant source of emissions of Ni, followed by mining and smelting of metals, forest fires, meteor ash and waste incineration (Bogdanović, 2007).

The obtained values of concentrations of manganese are given in Table 1. The sample 3 has an extremely high concentration of 193.36 mg / kg in comparison to the other samples. The content of the

samples is from 25.49 to 67.56 mg/kg. Although the increased value of Mn for the sample 3 relative to the other it is well below the average values found in the literature (1-700 mg/kg) (Obratov-Petković et al., 2008; Malenčić et al., 2003). On the manganese content in plants is mostly influenced by its content in soil as a main source (Stanković et al., 2011). In previous studies of soil values were obtained in the range from 496.69 to 832.92 mg/kg of dry soil. In most samples of manganese content in soil was reduced, which results in a relatively low value of Mn in plants. In this part of the park where the plant sample 3 was taken, content of Mn was 832.92 mg/kg.

The iron content obtained in the samples is in the range from 90.94 to 144.25 mg/kg (Table 1). The concentration iron in the plants is in the literature range, 5-200 mg/kg. On the basis this results we concluded that plant not polluted. The content of Fe is uniform in the leaves of all species with a small deviation in the sample 3.

As can be seen from Table 1 the content of Pb in all samples was less than 2.5 mg/kg and cadmium less than 0.07 mg/kg. In both cases obtained values were less than the literature values given in Table 1. The content of Cd in the soil (in the range 1.00-1.98 mg/kg) was less than values recommended by the national standard (3 mg/kg) (Antonijević-Nikolić et al., 2013). However, the content of Pb in two soil samples beside very frequent traffic street was above the values recommended by the national standard (100 mg/kg), which is attributed to the impact of traffic on soil (Antonijević-Nikolić et al., 2013).

Generally, the concentrations of selected metals in plants are in the literature range. Only in the case of Ni does the concentration exceed the range concentration given in the literature.

Based on these results, it can be said that traffic to a lesser extent affects the content of the studied metals in the plants and their pollution. As well as the content of Pb in some samples of soil was increased (Antonijević-Nikolić et al., 2013), in plants was in the literature range. Sources involved in the burning of fossil fuels, primarily coal, such as private homes, power plants and industry have a greater impact. In previously analysed soil the Ni content was increased whereas the other elements below the limited value recommended by the national standard (except for two samples with increased content Pb). Also Mn content was rather high in the part of the park where the high Mn concentration in plant was found. Based on this finding it can be proposed that soil composition influenced upmost on heavy metals adoption by selected plant species (Stanković et al., 2011).

## CONCLUSIONS

In this paper the content of heavy metals in the leaves of perennial plants from a park in Sabac was determined. The selected three plant species: *Acer platanooides*, *Acer pseudoplatanus* and *Liquidambar Styraciflna*. The content of heavy metals: Cd, Pb, Cu, Ni, Mn and Fe determined by atomic absorption spectroscopy. According to laboratory research can be concluded that:

- content Cd, Pb, Cu, Mn and Fe in all plant species is in the range of literature values
- content Ni in some samples (4 of 10) is greater the value obtained for the plant species from the literature
- increased Ni content in the tested plant species is similar and in soil samples from this location.
- adoption some elements by plants in large depending on its content in soil.

Based on the obtained results which are compared with previously analyzed soil from this location, it was concluded that the tested plant species as well as soil are more exposed to the combustion of fossil fuels than the impact of traffic.

The results obtained in this study together with previously analyzed soil in the future could be the basis for the establishment of systematic monitoring of soil quality and the environment in Sabac.

## REFERENCES

- Nagajyoti, C. P., Lee, D. K., & Sreekanth, M. V. T. (2010). Heavy metals, occurrence and toxicity for plants: a review. *Environmental Chemistry Letters*, 8, 199-216.
- Alloway, J. B. (1990). Heavy metal in soils, New York, NY, USA: John Wiley & Sons.
- Raskin, I., Kumar, N. A. B. P., Dushenkov, S., & Salt, E. D. (1994). Bioconcentration of heavy metals by plants. *Current Opinion in Biotechnology*, 5 (3), 285-290.
- Shen, Z., Li, X., Wang, C., Chen, H., & Chua, H. (2002). Lead phytoextraction from contaminated soil with high-biomass plant species. *Journal of Environmental Quality*, 31 (6), 1893-1900.
- Reeves, R. D., & Baker, A. J. M. (2000). Metal-accumulating plants. In: Raskin, I., & Ensley, B. D. (Eds) *Phytoremediation of Toxic Metals: Using Plants to Clean up The Environment*. New York, John Wiley & Sons, 193-229.
- Asati, A., Pichhode, M., & Nikhil, K. (2016). Effect of heavy metals on plants: an overview. *International Journal of Application or Innovation in Engineering & Management*, 5 (3), 56-66.
- Mahmood, T., & Islam, K. R. (2006). Response of rice seedlings to copper toxicity and acidity. *Journal of Plant Nutrition*, 29, 943-957.
- Lewis, S., Donkin, M. E., & Depledge, M. H. (2001). Hsp 70 expression in *Enteromorpha intestinalis* (Chlorophyta) exposed to environmental stressors. *Aqua Toxicol*, 51 (3), 277-291.
- Zornoza, P., Robles, S., & Martin, N. (1999). Alleviation of nickel toxicity by ammonium supply to sunflower plants. *Plant and Soil*, 208 (2), 221-226.
- Pandey, N., & Sharma, C. P. (2002). Effect of heavy metals  $\text{Co}^{2+}$ ,  $\text{Ni}^{2+}$ , and  $\text{Cd}^{2+}$  on growth and metabolism of cabbage. *Plant Science*, 163 (4), 753-758.
- Rahman, H., Sabreen, S., Alam, S., & Kawai, S. (2005). Effects of nickel on growth and composition of metal micronutrients in barley plants grown in nutrient solution. *Journal of Plant Nutrition*, 28, 393-404.
- Kitao, M., Lei, T. T., & Koike, T. (1997). Effects of manganese toxicity on photosynthesis of white birch (*Betula platyphylla* var. *japonica*) seedlings. *Physiologia Plantarum*, 101 (2), 249-454.
- Wu, S. (1994). Effect of manganese excess on the soybean plant cultivated under various growth conditions. *Journal of Plant Nutrition*, 17, 993-1003.
- Wojcik, M., & Tukiendorf, A. (2004). Phytochelatin synthesis and cadmium localization in wild type of *Arabidopsis thaliana*. *Plant Growth Regulation*, 44 (1), 71-80.
- Mohanpuria, P., Rana, N. K., & Yadav, S. K. (2007). Cadmium induced oxidative stress influence on glutathione metabolic genes of *Camella sinensis* (L.) O Kuntze. *Environmental Toxicology*, 22 (4), 368-374.
- Obratov-Petković, D., Bjedov, I., Belanović, S. (2008) Teški metali u listovima *Hypericum perforatum* L. na serpentinskim zemljištima Srbije, *Glasnik Šumarskog fakulteta*, 98, 143-154.
- Kadović, R., & Knežević, M. (2002). Teški metali u šumskim ekosistemima Srbije, *Šumarski fakultet Univerziteta u Beogradu i Ministarstvo za zaštitu prirodnih bogatstava i životne sredine Republike Srbije*, Beograd.
- Perić-Grujić A., Pocajt V., Ristic M. (2009) Određivanje sadržaja teških metala u čajevima sa tržišta u Beogradu, Srbija. *Hemijska Industrija*, 63 (5) 433-436
- Malenčić Đ. R., Kevrešan Ž. S., Popović M. T. (2003). Mineral composition of selected *salvia* species growing wild in the Vojvodina province. *Zbornika Matice srpske za prirodne nauke*, 105, 26-29
- Antonijević Nikolić M., Stanojević D., Ilić S. & Nikolić Đ. (2013). Teški metali u urbanom zemljištu Šapca. 8. *Simpozijum sa međunarodnim učešćem "Reciklažne tehnologije i održivi razvoj"*, Borsko jezero, 3.-5. jula 2013., Zbornik radova 245-252
- Bogdanović D. (2007). Izvori zagađenja zemljišta niklom, *Letopis naučnih radova Poljoprivrednog fakulteta*, 31(1), 21-28.
- Stanković D. M., Krstajić B. Đ., Šijačić-Nikolić M. T., Knežević M. N. (2011) Concentration of manganese and iron in some wood and herbs plants, *Zbornik Matice srpske za prirodne nauke*, 121, 39-49

V International Conference  
„ECOLOGY OF URBAN AREAS“ 2016

**AVAILABLE CONCENTRATIONS OF CU, MN, NI, PB AND ZN  
IN SOILS NEAR URBAN ROADS**

**Aleksandra Mihailović<sup>1\*</sup>, Bogdana Vujić<sup>2</sup>, Jordana Ninkov<sup>3</sup>, Milica Vučinić Vasić<sup>1</sup>,  
Stanko Milić<sup>3</sup>, Savka Adamović<sup>1</sup>, Robert Lakatoš<sup>1</sup>**

<sup>1</sup>Faculty of Technical Sciences, Novi Sad, University of Novi Sad, Republic of Serbia

<sup>2</sup>Faculty of Technical Sciences “Mihajlo Pupin”, Zrenjanin, University of Novi Sad, Republic of Serbia

<sup>3</sup>Institute of Field and Vegetable Crops, Novi Sad, Republic of Serbia

\*zandra@uns.ac.rs; bogdana.vujic@tfzr.rs; jordana.ninkov@ifvcns.ns.ac.rs;

milicavv@uns.ac.rs; stanko.milic@ifvcns.ns.ac.rs; adamovicsavka@uns.ac.rs; laki@uns.ac.rs

**ABSTRACT**

*This paper reports on the available heavy metals concentration in urban soils of Novi Sad, Serbia. A total of 121 top soil bulk samples (0-10 cm depth) were collected. The soil samples were taken across the central part of the city covering a surface area of 4 km x 5 km. The physicochemical properties of soil samples were obtained following a standard procedure. After ethylenediamine-tetra-acetic-acid (EDTA) extraction the mean available concentrations of Cu, Mn, Ni, Pb and Zn were 8.6, 15.9, 0.8, 28.3 and 13.8 mg/kg, respectively. The availability ratio of the studied metals were calculated: the highest mean value was obtained for Pb (0.3) followed by Cu (0.22) and Zn (0.13). The values were significantly lower for Ni (0.03) and Mn (0.04). This result support anthropogenic origin of Cu, Pb and Zn.*

**Key words:** Heavy metals, Urban soils, Metal availability, EDTA extraction.

**INTRODUCTION**

Soil pollution by heavy metals is a widespread problem posing a significant risk to human health or the environment. Numerous studies in recent decades have shown that total metal concentrations in the environment do not fully represent their geochemical properties such as mobility and reactivity or biological characteristics (accessibility, toxicity) (Kabata-Pendias, 2004; Menzies et al., 2007). Various factors that may be geochemical, climatic and biological origin have influence on mobility and accessibility of metals in soils. In contaminated soils heavy metals accumulate significantly at the exchangeable, carbonate and oxide fraction, while in non-contaminated soils and sediments typically found in the residual fraction. Current research also confirms that heavy metals in soils derived from anthropogenic inputs are in forms that are more easily accessible compared to the metals originating from natural sources.

The content of available metal ( $Me_{EDTA}$ ) is often determined by extraction with EDTA. Fractions of metal after extraction of soil with EDTA are: water-soluble fraction, removable fraction and fraction associated with carbonates (Ramos et al., 2006). EDTA is a very effective chelating agent for the analysis of heavy metals and micronutrients in the soil (Peveřill et al., 1999). Chelating agents reduce the activity of free metal ions in solution by creating soluble metal-chelate complexes. The amount of metal extracted using chelating agent is a function of two factors: the concentration of metal in the soil and its availability. Thus, chelating agents may be used to determine available metal content because they "simulate" natural processes of the metal uptake by plants.

Few studies examined heavy metals content in the soils of Novi Sad and Vojvodina (Sekulić et al., 2011; Ninkov et al., 2012; Škrbić and Đurišić-Mladenović, 2013; Mihailović et al., 2015). In the paper Mihailović et al., (2015), a detailed investigation of heavy metals total content in urban soils of Novi Sad was conducted and contour maps of spatial distribution for eight metals were obtained. The aims of the present study were: to measure the available concentrations of Cu, Mn, Ni, Pb and Zn in surface soils of Novi Sad, to determine availability ratio and to estimate pollution sources. The economic mismanagement in the last decades lead to decay or demise of once large industrial combines in area

of Novi Sad. It is considered that the main pollution sources in the area studied in this work may be traffic, oil refining and combusting for home heating in some parts of the city.

### SAMPLING AND ANALYSIS

A total amount of 121 surface soil samples (0 - 10 cm depth) were taken across the central part of the city covering a surface area of 20 km<sup>2</sup>. Sampling sites are shown on the map of Novi Sad presented in Fig. 1. A representative sample was made by mixing sub-samples collected from several random points within about 30 m<sup>2</sup>. From the locations next to the roads the samples were taken within the distance of 1 - 2 m from the pavement. The soil samples were airdried at room temperature and milled to a particle size of < 2 mm. Soil chemical properties pH(KCl), calcium carbonate (CaCO<sub>3</sub>), organic matter (OM) and available phosphorus (AL P<sub>2</sub>O<sub>5</sub>) were obtained following standard procedures. Particle size distribution of the soil were determined by the internationally recognized pipette method. The size fractions were defined as sand (0.02 - 2 mm), silt (0.002 - 0.02 mm) and clay (< 0.002 mm).

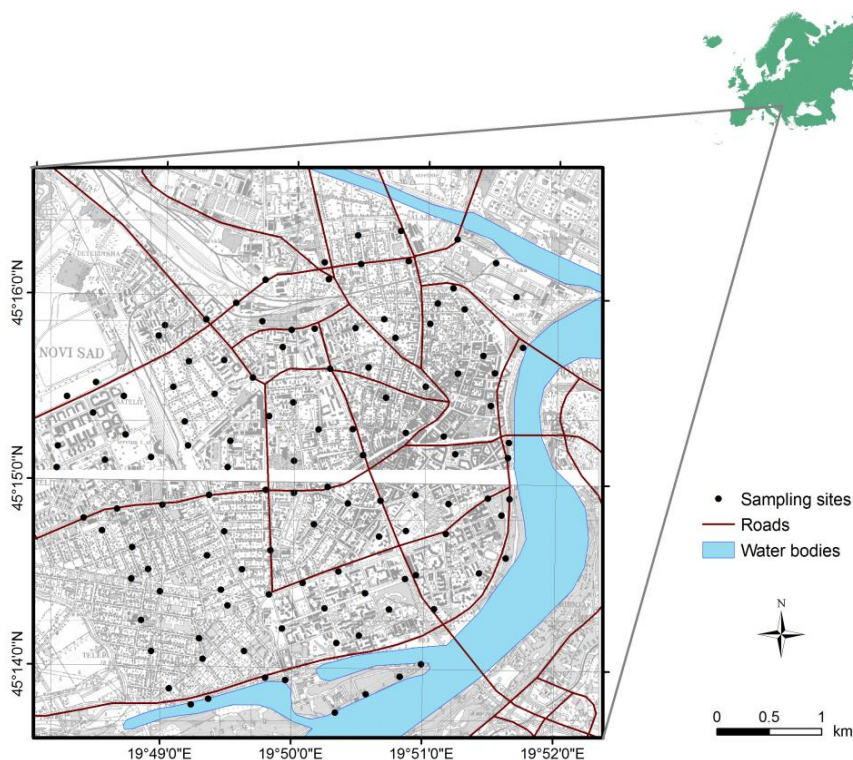

Figure 1. Sampling locations of urban soils in Novi Sad

The samples were analyzed for available metal content after extraction with 0.05 mol/l EDTA (pH = 7.00) according to EDTA procedures BCR European Commission Joint Research Centre, Institute for Reference Materials and Measurements CRM 484 Sewage sludge amended (terra rosa) soil. The concentrations of metals were determined by ICP-AES (Vista Pro-Axial, Varian) in accordance with US EPA method 200.7:2001. The limits of detection for available concentrations of the investigated metals were: 0.1 mg/kg for Ni and 0.5 mg/kg for Cu, Mn, Pb and Zn.

### RESULTS AND DISCUSSION

Some basic chemical and physical characteristics of the soil are summarized in Table 1. pH values (7.2 - 7.9) suggest sub-alkaline conditions. Calcium carbonates range from 3.8 to 19.4 % and more than 2/3 of soil samples varied from medium to high levels of CaCO<sub>3</sub>. The soils are weakly to moderately fortified with organic matter with the mean value of 2.86 %. According to the results of

particle size analysis, the soils of the study area show a sandy structure: 70 % of the samples are classified as sandy loam.

Table 1: Statistical description of chemical and physical soils characteristics (N = 121)

	pH (KCl)	CaCO <sub>3</sub> (%)	OM (%)	AL P <sub>2</sub> O <sub>5</sub> [mg/100 g]	Sand (%)	Silt (%)	Clay (%)
Mean	7.53	11.6	2.86	36.3	76.3	15.3	8.4
Median	7.54	11.4	2.92	29.8	78	15.2	6.8
Range	7.2 - 7.9	3.8 - 19.4	1.47 - 3.9	6.0 - 131.5	46.8 - 96	2.3 - 29.7	1.6 - 23.5

It is known that available concentrations of heavy metals in soils are significantly lower than total concentrations, but it primarily depends on soil properties and individual metals (Lončarić et al., 2012). The available content of heavy metals in urban soils of Novi Sad and some basic statistical parameters are presented in Table 2. The available concentrations of the studied metals showed a large variability from site to site, and the RSD values exceeded those for pseudo-total metal content. The available concentration mostly varied for Cu (1.64) and Pb (2.24) and for other three metals value of RSD was in the range 0.48 - 0.58.

Table 2: Statistics of available metal content in urban soils of Novi Sad (mg/kg) (N = 121)

	Cu	Mn	Ni	Pb	Zn
Mean	8.6	15.9	0.8	28.3	13.8
Range	1.2 - 151.6	7.4 - 69.8	0.2 - 2.8	2.5 - 665.6	1.7 - 43.7
SD	14.1	7.7	0.4	63.4	7.9
RSD <sup>a</sup>	1.64 (1.49)	0.49 (0.19)	0.48(0.30)	2.24 (1.35)	0.58 (0.30)

<sup>a</sup>The values given in parentheses relate to pseudo-total metal content (Mihailović et al., 2015)  
SD: Standard deviation; RSD: Relative standard deviation

The toxicity of metals for plants and animals including humans depends not only on their total concentrations, but also on their mobility and reactivity with other components of the ecosystem (Adriano 2001; Abolino et al., 2002). Although total content of heavy metals in soil is not always very high, potential risk for the environment could exist if significant portion of available metals appears in the soil. Elevated levels of available metals increase **entry of metals into the food chain**. There have been no strictly defined limit values for available metals in soils as well as for total metal content. However, one important indicator is a relative portion of available heavy metals fraction in total heavy metals content in soil. Mean values of the available ratio (AR) for five metals are given in Table 3. The highest mean value was obtained for Pb (0.3) followed by Cu (0.22) and Zn (0.13). The values are significantly lower for Ni (0.03) and Mn (0.04).

Table 3: Mean pseudo-total and available concentration of metals and available ratio (AR) in urban soils of Novi Sad (N = 121)

	Cu	Mn	Ni	Pb	Zn
<sup>b</sup> c(Tot) [mg/kg]	38.8	368.6	28.7	82.3	100.3
<sup>c</sup> c(EDTA) [mg/kg]	8.6	15.9	0.8	28.3	13.8
AR = c(EDTA)/c(Tot)	0.222	0.043	0.026	0.300	0.128

<sup>b</sup>Mihailović et al., 2015; <sup>c</sup>This study

The histograms of available fraction ratio for Cu, Pb and Zn are shown in Fig. 2. Half of the samples for Cu are within the interval 0.2 - 0.3, and 10% of the samples exceeded a value of 0.3. For Pb

following values were obtained: 1/2 of the samples were within the interval 0.2 - 0.3, for 1/3 of the samples percentage of soil samples ranged from 0.3 - 0.4 and for one sample the value was  $> 0.67$ .

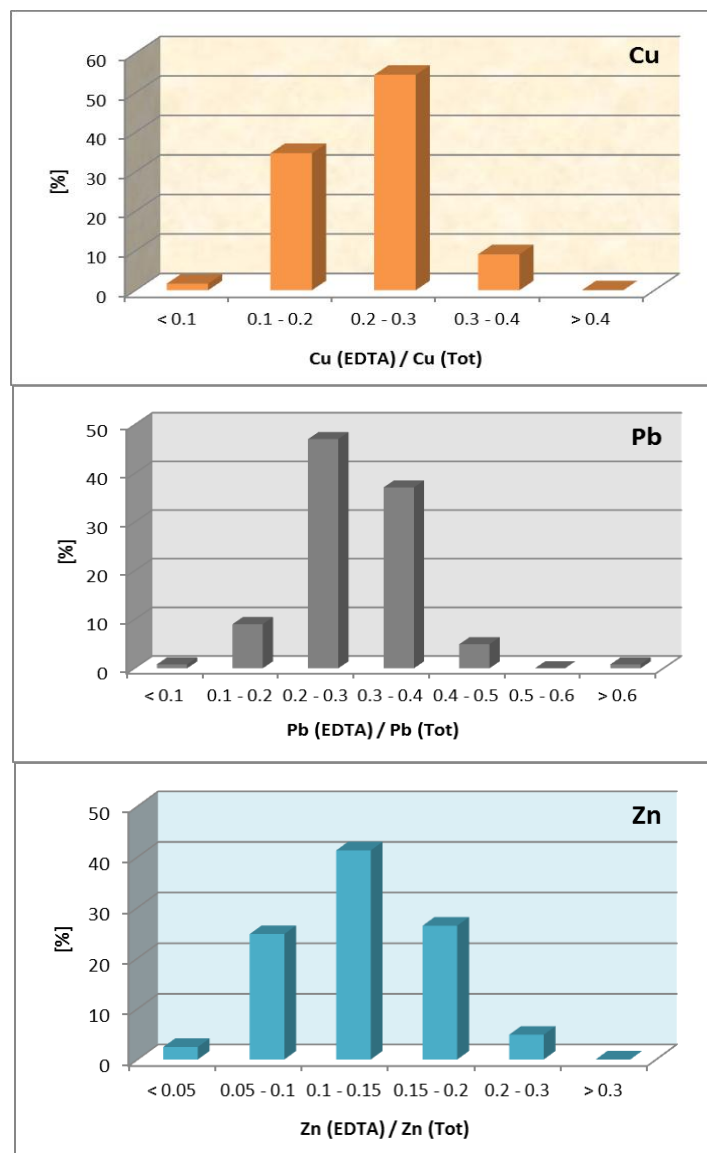

Figure 2. The percentage of soil samples and available ratio for Cu, Pb and Zn

Zn values were smaller comparing to Cu and Pb but greater comparing to Mn and Ni. It is known that higher values of available metal content in soils point to anthropogenic pollution, thus we concluded that Pb, Cu and Zn originated from anthropogenic sources. This is in agreement with the previous studies (Mihailović et al., 2015). In that paper, the authors came to the conclusion that Cu, Pb and Zn were related to anthropogenic activities and Mn and Ni were derived from natural sources. The statement was based on multivariate analysis of the data. Spatial distribution patterns of the investigated metals in urban soils of Novi Sad implied that traffic was the most important source of pollution.

It was also confirmed in literature data that increased ratio of available metal is typical in polluted soils comparing to unpolluted soils (Wilcke et al., 1998; Massas et al., 2010). This is particularly observed for recently contaminated soils where metals are not yet tied for soil particles (for example adsorbed on colloids and organic matter).

## CONCLUSION

The available concentration of five metals (Cu, Mn, Ni, Pb, and Zn) in urban soils of Novi Sad was determined using ICP-OEA technique and the availability ratio (AR) was calculated. The Available concentration mostly varied for Cu and Pb. The highest mean value of AR was obtained for Pb (0.3) followed by Cu (0.22) and Zn (0.13). The values were significantly lower for Ni (0.03) and Mn (0.04). The results indicate that Cu, Pb and Zn originated from antropogenic sources and support a natural origin of Mn and Ni.

## ACKNOWLEDGEMENT

The research is supported by the Project of the Ministry of Education, Science and Technological Development, Republic of Serbia, No. TR34014.

## REFERENCES

- Adriano, D. (2001) Trace Elements in Terrestrial Environments: Biochemistry, Bioavailability and Risks of Metals. Springer-Verlag, New York, NY, USA.
- Abollino, O., Aceto, M., Malandrino, M., Mentasti, E., Sarzanini, C., Petrella, F. (2002) Heavy metals in agricultural soils from Piemonte, Italy. Distribution, speciation and chemometric data treatment. *Chemosphere*, 49, 545–557.
- Chenery, S.R., Izquierdo, M., Marzouk, E., Klinck, B., Palumbo-Roe, B., Tye, A.M. (2012) Soil plant interactions and the uptake of Pb at abandoned mining sites in the Rookhope catchment of the N. Pennines, UK - A Pb isotope study. *Science of The Total Environment*, 433, 547-560.
- Fernandez-Calvino, D., Rodriguez-Suarez, J.A., Lopez-Periago, E., Arias-Estevez, M., Simal-Gandara, J. (2008) Copper content of soils and river sediments in a winegrowing area, and its distribution among soil or sediment components. *Geoderma*, 145, 91-97.
- Kabata-Pendias, A. (2004). Soil-plant transfer of trace elements - an environmental issue. *Geoderma*, 122, 143-149.
- Lončarić, Z., Popović, B., Karalić, K., Rekasi, M., Kovačević, V. (2010) Regression model for prediction availability of essential heavy metals in soil, in: Gilkes, R.J., Prakongep, N. (Eds.), *Proceedings of 19th World Congress of Soil Science*. ISSS. Brisbane, Australia.
- Luo, X.S., Yu, S., Li, X.D. (2012) The mobility, bioavailability, and human bioaccessibility of trace metals in urban soils of Hong Kong. *Applied Geochemistry*, 27(5), 995-1004.
- Madrid, L., Diaz-Barrientos, E., Madrid, F. (2002). Distribution of heavy metal contents of urban soils in parks of Seville. *Chemosphere*, 49, 1301-1308.
- Massas, I., Ehaliotis, C., Kalivas, D., Panagopoulou, G. (2010) Concentrations and Availability Indicators of Soil Heavy Metals; the Case of Childrens Playgrounds in the City of Athens (Greece). *Water, Air, & Soil Pollution*, 212, 51-63.
- McGrath, D. (1996) Application of single and sequential extraction procedures to polluted and unpolluted soils. *Science of the Total Environment*, 178 37-44.
- Menzies, N.W., Donn, M.J., Kopittke, P.M. (2007) Evaluation of extractants for estimation of the phytoavailable trace metals in soils. *Environmental Pollution*, 145, 121-130.
- Mihailović, A., Budinski-Petković, Lj., Popov, S., Ninkov, J., Vasin, J., Ralević, N.M., Vučinić Vasić, M. (2015) Spatial distribution of metals in urban soil of Novi Sad, Serbia; GIS based approach, *Journal of Geochemical Exploration*, 150, 104-114.
- Ninkov, J., Sekulić, P., Milić, S., Vasin, J., Zeremski, T., Brunet, B. (2012) Pseudototal contents of nickel and chromium in agricultural soils of Northern Vojvodina Province, Serbia. *Conference Proceedings of the „International Multidisciplinary Scientific GeoConference & EXPO - SGEM (Surveying Geology & mining Ecology Management)“* Volume IV. 17.-23.06.2012. Albena, Bulgaria, 205-212. DOI: 10.5593/SGEM2012/S16.V4022.
- Peverill, K.I., Sparrow, L.A., Reuter, D.J. (1999) Soil Analysis: An Interpretation Manual. CISRO Publishing.
- Ramos, M.C. (2006) Metals in vineyard soils of the Penedes area (NE Spain) after compost application. *Journal of Environmental Management*, 78, 209-215.
- Sekulić, P., Ninkov, J., Zeremski-Škorić, T., Vasin, J., Milić, S., Lazić, N., Vujić, B. (2011) Monitoring quality of Vojvodina soils. *JRC Scientific and Technical Reports EUR 24889 EN - 2011: Soil Protection Activities and Soil Quality Monitoring in South Eastern Europe. Conference papers*. 18-19.06.2009. Sarajevo, Bosna i Hercegovina, 119-126.



- Škrbić, B., Đurišić-Mladenović, N. (2013) Distribution of heavy elements in urban and rural surface soils: the Novi Sad city and the surrounding settlements, Serbia. *Environmental Monitoring and Assessment*, 185(1), 457-471.
- Wilcke, W., Muller, S., Kanchanakool, N., Zech, W. (1998) Urban soil contamination in Bangkok: heavy metal and aluminum partitioning in topsoils. *Geoderma*, 86, 211-228.

V International Conference  
„ECOLOGY OF URBAN AREAS“ 2016

**THE QUALITY OF AGRICULTURAL SOILS NEAR INDUSTRIAL  
ZONES OF THE CITY OF NOVI SAD**

**Jordana Ninkov\*<sup>1</sup>, Aleksandra Mihailović<sup>2</sup>, Dušana Banjac<sup>1</sup>, Milorad Živanov<sup>1</sup>, Ivana Stanivuković<sup>1</sup>, Snežana Jakšić<sup>1</sup>, Jelena Marinković<sup>1</sup>**

<sup>1</sup>Institute of Field and Vegetable Crops, Serbia

<sup>2</sup>University of Novi Sad, Faculty of Technical Sciences,

jordana.ninkov@nsseme.com; zandra@uns.ac.rs; dusana.banjac@nsseme.com; milorad.zivanov@nsseme.com;  
ivana.stanivukovic@nsseme.com; snezana.jaksic@nsseme.com; jelena.marinkovic@nsseme.com

**ABSTRACT**

*Due to the rapid increase of the urban population, food production in cities has become a modern need. Urban agriculture affects the urban environment, and is simultaneously affected by it. The aim of this study was to analyse the quality of soils for safe food production. A total of 15 soil samples were collected from agricultural top soils (depth 0-30 cm) from the vicinity of the industrial zones of the City of Novi Sad, Serbia. The collected samples were analysed for basic soil properties and pseudo-total content of trace elements. Soil pH value was dominantly slightly alkaline, and it was in correlation with carbonate content, which is a natural characteristic of a wider area. According to the readily available P<sub>2</sub>O<sub>5</sub>, analysed soils fell within the interval from very poor (<5 mg/100g) to toxic content (>50 mg/kg). Content of readily available K<sub>2</sub>O fell within the interval from poor (5-10 mg/100g) to high level (25-50 mg/100g). None of the analysed samples exceeded MAC for agricultural soils regarding the content of trace elements (Cu, Zn, As, Pb, Cd, Ni, and Cr). Analysed agricultural soils are suitable for safe food production. Farmers do not apply rational doses of mineral fertilizers. Excessive use of mineral fertilizers might affect the urban environment, which indicates the necessity for a broader training of farmers regarding optimal fertilizer doses.*

**Key words:** soil, phosphorus, potassium, trace elements.

**INTRODUCTION**

Agricultural production is traditionally linked to rural areas. Nowadays, we are witnessing the rapid increase of urban population, and the food production in cities has been imposed as a great need of modern human society. In 2007, for the first time in human history, the rate of population inhabiting urban centres overtook the rural one. Projections indicate that by 2020, 55% of the world population will live in the urban centres, and this percentage will rise up to 60% and 70% in 2030 and 2050, respectively. The urban population expansion is more pronounced in developing countries as the result of rural-to-urban migration and natural population growth (Orsini et al., 2013; Eigenbrod and Gruda, 2015).

Analyses indicate that city soils are more polluted than those in rural areas (De Bon et al., 2010). Urban and peri-urban agriculture – jointly referred to as UPA, is perceived as agricultural practices within and around cities which compete for resources (land, water, energy, labour) that could also serve other purposes to satisfy the requirements of the urban population. The opportunities include: access to consumer markets, less need for packaging, storage and transportation of food, potential agricultural jobs and incomes, non-market access to food for poverty-struck consumers, availability of fresh, perishable food, proximity to services, including waste treatment facilities, waste recycling and re-use possibilities. On the other hand, the risks include: environmental and health risks from inappropriate agricultural and aqua-cultural practices, increased competition for land, water, energy, and labour, as well as reduced environmental capacity for pollution absorption (FAO, 1997). Therefore, urban agriculture affects and is also affected by the urban environment (Orsini et al., 2013).

Novi Sad is the second largest city in Serbia after capital city Belgrade, with estimated population of about 370,000. It is located in the southern part of the Pannonian Plain on the Danube River. A large part of Novi Sad lies on a fluvial terrace with an elevation of 72-80 m above sea level (latitude 45° 15' N; longitude 19° 50' E). Potential sources of soils pollution in the city are related to industrial, commercial, agricultural activities, and automobile exhaust (Škrbić and Đurišić-Mladenović, 2013).

The aim of this study was to analyse the quality of soils for safe food production near industrial zones of the City of Novi Sad. Industrial emissions used to be the main source of pollution, but a set of legislative acts and general compliance with EU regulations decreased this, especially regarding monitoring emission to air, water and land, and setting limit values. Another reason for reduced environmental pollution in the City of Novi Sad is a significant decrease of industrial production due to economic crisis.

## MATERIALS AND METHODS

### Study area and sample collection

Total of 15 soil samples were collected from 15 agricultural field plots from the vicinity of three large industrial zones in Novi Sad (North I, II, IV), near asphalt facility in the village of Rumenka, and in the vicinity of the public waste disposal site (Figure 1). These plots were under different crops, as can be seen in Table 1. The topsoil samples were taken from the depth 0-30 cm. This depth was chosen as a zone of the most active root systems of vegetable crops. The samples were taken using a soil drill agrochemical probes and stored in polyethylene bags. One composite sample represented 20-25 subsamples from random points in each sampling site. The initial quantity of samples was approximately 1.5 kg. The soil samples were air-dried at room temperature, milled and sieved to a particle size of <2 mm, in accordance with ISO 11464: 2006.

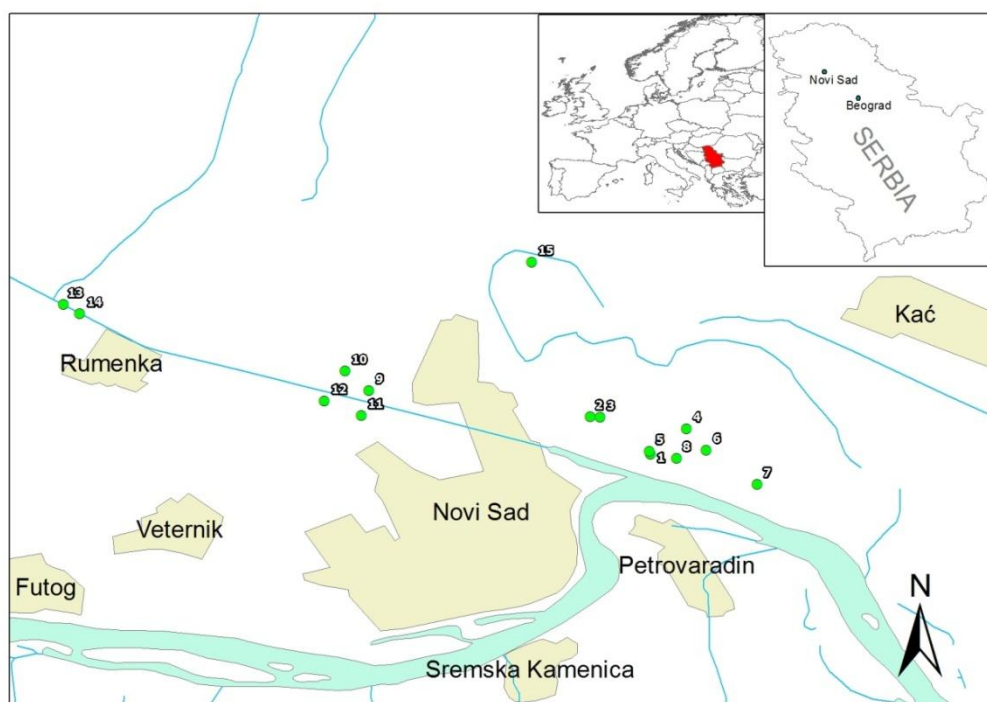

Figure 1. Locations of collected soil samples

## Laboratory analysis

All laboratory analyses were performed in the Laboratory for Soil and Agroecology of the Institute of Field and Vegetable Crops, Novi Sad, Serbia, accredited according to the standard ISO/IEC 17025: 2005.

The pH value 1:5 (V/V) suspension of soil in 1 mol/L KCl was determined using glass electrode according to ISO 10390: 2005. The carbonate content, as CaCO<sub>3</sub> content, was determined according to ISO 10693: 1995 volumetric method. The organic matter (OM) content was measured by oxidation using the sulphochromic oxidation method by ISO 14235: 1998. Available phosphorus (P<sub>2</sub>O<sub>5</sub>) and available potassium (K<sub>2</sub>O) were determined by ammonium lactate extraction (Egner and Riehm, 1955), followed by spectrophotometry and flame photometry detection, respectively.

The samples were analysed for pseudo-total contents of Cu, Zn, Co, As, Pb, Cd, Ni and Cr after microwave digesting the soil in concentrated HNO<sub>3</sub> and H<sub>2</sub>O<sub>2</sub> (5 HNO<sub>3</sub> : 1 H<sub>2</sub>O<sub>2</sub>, and 1 : 12 solid : solution ratio) by stepwise heating up to 180°C using a Milestone Vario EL III for 55 min. The concentrations of the elements were determined by ICP-OES (Vista Pro-Axial, Varian). Quality control was periodically carried out with IRMM BCR reference materials 143R and deviations were within ±15% of the certified values.

## RESULTS AND DISCUSSION

### Basic soil properties

Soil pH value ranged from 5.69 (slightly acid) to 7.62 (slightly alkaline) with an average value 6.91±0.60 (neutral) (Table 1). Based on the share of individual samples, soil pH was dominantly slightly alkaline. Soil pH is an important parameter that reflects the course of other physical and chemical reactions in the soil. Initially, pH is conditioned by pedogenic factors, but at the same time it is affected by anthropogenic factors due to fertilization, practice in managing organic matter, occurrence of acid rains, etc. Neutral reaction of soils is desirable because it implies lower availability of heavy metals.

Table 1: Basic soil properties

No	Location	Crop	pH in KCl	CaCO <sub>3</sub> %	Organic matter %	AL-P <sub>2</sub> O <sub>5</sub> mg/100g	AL-K <sub>2</sub> O mg/100g
1	North IV-1	vegetable	7.12	10.4	4.46	81.9	14.7
2	North IV-2	orchard	7.37	14.5	2.64	10.1	5.8
3	North IV-3	soybean	6.55	19.3	2.12	138.5	30.5
4	North IV-4	soybean	7.35	11.9	2.99	16.6	12.7
5	North IV-5	vegetable	7.36	15.6	3.49	54.4	10.0
6	North IV-6	maize	7.24	15.0	3.55	10.3	12.7
7	North IV-7	wheat	7.32	19.7	2.50	15.8	13.1
8	North IV-8	oilseed rape	7.22	12.8	4.58	6.0	10.7
9	North I-1	soybean	5.84	0.2	2.54	7.8	28.5
10	North I-2	soybean	6.13	0.6	2.78	6.2	29.4
11	North II-1	alfalfa	5.69	0.3	2.22	3.5	21.7
12	North II-2	maize	6.61	0.6	3.14	29.0	30.5
13	Rumenka-1	strawberry	7.06	0.8	3.37	12.7	29.3
14	Rumenka-2	maize	7.16	1.9	2.18	11.3	24.5
15	Waste site	soybean	7.62	13.5	2.39	22.0	10.0
Min			5.69	0.2	2.12	3.50	5.81
Max			7.62	19.7	4.58	138.50	30.52
Average ±SD			6.91 ±0.60	9.1 ±7.50	3.00 ±0.77	28.41 ±37.07	18.94 ±9.05

According to the carbonate content, as  $\text{CaCO}_3$  content, tested samples belong to a category from slightly calcareous (<2%) to highly calcareous soil (>10%) (Table 1). According to average value of  $\text{CaCO}_3$  content, soils belong to the category of calcareous (5-10%) with a wide range of results (Table 1). Carbonate content in soils is always correlated with soil pH. Such pH and carbonate content is a natural characteristic of a wider area (Milić et al. 2011).

The content of organic matter (OM) ranged from slightly humic to humic soil. According to the average value of organic matter content, soils belong to the category of humic (3-5%) (Table 1). Study on the role of OM in metal mobility presents apparently contradictory results. Soil OM has a high binding capacity for cationic and organic contaminants, which might lead to immobilization of metal ions. In other studies, however, the degradation of OM released low molecular weight of organic acids that bound metals and increased metal solubility. As reported by Murray et al. (2011), compost amendment increased the accumulation of metals in the vegetables.

Readily available  $\text{P}_2\text{O}_5$  in agricultural soils ranged from very poor (<5 mg/100 g) to toxic levels (<100 mg/kg) with mean value  $28.41 \pm 37.07$  mg/100 g, which belongs to the high content (50-100 mg/100 g). Based on the share of individual samples, four of the analysed agricultural soils belong to the category over optimum content (>25 mg/100g) (Table 1).

Readily available  $\text{K}_2\text{O}$  in agricultural soils ranged from poor to high levels with mean value  $18.94 \pm 9.05$  mg/100 g that belongs to optimum level. The results had wide range in both nutrients parameters (readily available  $\text{P}_2\text{O}_5$  and  $\text{K}_2\text{O}$  content) (Table 1).

Despite many efforts to increase productivity, water and fertilizers are the major inputs used in agricultural production to provide disease- and pest-resistant varieties and to develop techniques for small areas (De Bon et al. 2010). According to Milić et al. (2011), the soil of broader study area (South Bačka) used for field crop production, averagely contains 33% of areas that have the optimum P levels, while 30% of areas has higher than this level (dominantly in high P class, 21%). In that study 44% of areas had the optimum level of K, while K content above this level was found in 51% of areas (dominantly in high K class, 45%). Such distribution of nutrients in broader study area is a consequence of irrational and excessive use of fertilizers, and in case of K content – present pedological soil loess, which is naturally rich in potassium. Excessive nutrient levels in urban garden soils were studied worldwide (Witzling et al. 2011; Abdulkadir et al. 2013; Gregory et al. 2015; Joimel et al. 2016; Yesilonis et al. 2016). Authors indicate the importance of education and soil testing, which is insufficiently practiced. Excessive use of fertilizers in urban gardens is a serious pressure on urban environment, since these nutrients can enter open watercourses and ground water by rinsing (Cheng et al. 2014; Pfeifer and Bennett, 2011).

### **Heavy metals content**

Urban soils carry greater risk of pollution by heavy metals from anthropogenic sources. The largest sources of this contamination are heavy industry and run-off from highway drains. The degree and direction of the slope from the interstate toward the soil plot is an important factor (Trammell et al. 2011). Exposure of the human population to potentially toxic elements (PTE), such as lead (Pb), copper (Cu), chromium (Cr), nickel (Ni), and zinc (Zn) in agricultural soils may occur through inhalation of particles or through the consumption of soil or vegetables and fruit grown in contaminated soils (Boim et al. 2016).

The concentration of heavy metals in urban grown vegetables is strictly related to the site in the city where plants are grown. When plants are cultivated near pollution sources (e.g. main roads), risks of heavy metal accumulation increases (about 1.5-fold when vegetables are grown 10 m from the road as compared to 60 m away) (Antisari et al. 2015). Risk assessment of heavy metals in soils is especially important for vacant lots slated for urban agriculture in post-industrial city (Sharma et al 2015).

According to the criteria for MAC (Maximum Available Concentration) for agricultural land (Official Gazette RS 23/1994), no agricultural soil samples exceeded MAC (Table 2).

Table 2: Heavy metals content

No	Location	Cu	Zn	Co	As	Pb	Cd	Ni	Cr
		mg/kg	mg/kg	mg/kg	mg/kg	mg/kg	mg/kg	mg/kg	mg/kg
1	North IV-1	40.2	111.9	9.6	5.1	31.5	0.37	32.5	23.6
2	North IV-2	18.8	56.2	8.8	7.9	17.8	0.36	24.2	28.4
3	North IV-3	44.2	91.1	10.7	13.5	22.5	<0.10	33.0	34.8
4	North IV-4	27.7	88.3	11.6	10.4	19.0	<0.10	36.7	53.0
5	North IV-5	34.1	112.5	11.4	8.0	30.4	<0.10	35.6	34.5
6	North IV-6	30.2	85.9	11.5	6.7	26.7	0.28	34.5	39.3
7	North IV-7	25.4	69.5	11.1	8.9	28.1	0.34	34.6	24.9
8	North IV-8	25.1	90.0	10.9	10.2	29.5	0.52	33.3	38.9
9	North I-1	23.8	60.3	13.0	6.0	26.4	0.29	36.5	30.8
10	North I-2	25.2	83.1	13.9	14.0	26.3	0.47	43.2	58.2
11	North II-1	24.4	57.5	13.8	7.9	26.5	0.29	37.1	30.1
12	North II-2	28.1	92.1	15.0	13.9	28.1	0.55	43.6	54.8
13	Rumenka-1	24.2	68.1	12.4	9.0	20.8	0.14	36.3	44.6
14	Rumenka-2	26.1	81.9	14.1	9.1	24.6	0.26	45.5	63.2
15	Waste site	14.7	88.9	6.7	5.5	15.4	<0.10	19.5	22.9
MAC		100.0	300.0	/	25.0	100.0	2.00	50.0	100.0
Min		14.7	56.2	6.7	5.1	15.4	0.14	19.5	22.9
Max		44.2	112.5	15.0	14.0	30.4	0.55	45.5	63.2
Average		26.6	80.4	11.8	9.4	24.4	0.35	35.3	39.9
±SD		±7.5	±17.4	±2.2	±2.9	±4.8	±0.1	±6.7	±13.2

Average copper content in soil was  $26.6 \pm 7.5$  mg/kg, which is higher than background concentration for Vojvodina soils of 17.1 mg/kg (Kastori, 1993). Anthropogenic effect is indicative based on previous studies (Ralev et al., 2003; Ninkov et al., 2012) as a consequence of the application of copper based fungicides.

Average content of pseudo-total zinc in agricultural soils was  $80.4 \pm 17.4$  mg/kg. Zinc in soil near roads could have been deposited by the wear and tear of vehicle bodies with common galvanizing of steel surfaces (Jim, 1998). In the others studies (Škrbić and Đurišić-Mladenović, 2013; Joimel et al. 2016), zinc content was also higher in urban garden soils than in cultivated soils. In studies at the same site (City of Novi Sad), the origin of Zn from anthropogenic sources was confirmed (Mihailović et al., 2015).

Average content of pseudo-total cobalt in agricultural soils was  $11.8 \pm 2.2$  mg/kg. Cobalt pseudo-total content does not have MAC defined in the Regulation on agricultural soils. Content of Co was above background limit for European soils which is 20 mg/kg (Houskova and Montanarella, 2006). According to previous studies at the same site (the City of Novi Sad), the mean value of Co in urban soil was 7.3 (Mihailović et al., 2015), or 14.3 mg/kg (Škrbić and Đurišić-Mladenović, 2013), while in rural soil it was 15.7 mg/kg (Škrbić and Đurišić-Mladenović, 2013), at 0-10 cm soil depth.

Average content of pseudo-total arsenic in agricultural soils was  $9.4 \pm 2.9$ . Generally, the analysed soils are not at risk of environmental pollution with arsenic, which is good news since it is an extremely toxic metal.

Average content of pseudo-total lead in agricultural soils was  $24.4 \pm 4.8$ . Lead is one of the most common contaminants in urban areas with its origin in vehicle exhaust gases (Davies, 1995). Tendency of lowering lead concentration in soil is still slow even after it was forbidden as gasoline additive due to its habit to accumulate in soil and bind to soil components. In previous studies at the same site (the City of Novi Sad), Pb content was higher in urban soil than in rural (Škrbić and Đurišić-Mladenović, 2013), while it was confirmed that lead originated from anthropogenic source (Mihailović et al., 2015; Sharma et al., 2015). In the soil of gardens of the City of Chicago, the overall mean lead level was 135 ppm; individual soil samples from gardens ranged from 10 to 889 ppm, a level high enough to cause concern (Witzling et al., 2011).

Average content of pseudo-total cadmium in agricultural soils was  $0.35 \pm 0.1$ . According to previous studies at the same site (the City of Novi Sad), the mean value of Cd in urban soil was 1.59, and in rural 1.73 mg/kg (Škrbić and Đurišić-Mladenović, 2013), at the 0-10 cm soil depth.

Average content of pseudo-total nickel in agricultural soils was  $35.3 \pm 6.7$ . Some other cases were reported where Ni content in broader study area was above the MAC, and their geochemical origin was confirmed (Dozet et al., 2011). According to previous studies at the same site (City of Novi Sad), mean value of Ni in urban soil was 28.7 (Mihailović et al., 2015), or 23.2 (Škrbić and Đurišić-Mladenović, 2013) mg/kg, and in rural soil it was 29.8 mg/kg (Škrbić and Đurišić-Mladenović, 2013), at 0-10 cm soil depth.

Average content of pseudo-total chromium in agricultural soils was  $39.9 \pm 13.2$ . In the same case as Ni, some studies reported where Cr content in broader study area was above the MAC, and their geochemical origin was confirmed (Sekulić et al., 2011)

Since heavy metals content was below MAC value in the whole study, none of the analysed field plots near industrial zones has quality limited by those elements.

## CONCLUSION

Soil pH was dominantly slightly alkaline, and it was correlated with carbonate content, which is a natural characteristic of a wider area. According to the readily available  $P_2O_5$ , analysed soils fell within the interval from very poor ( $< 5$  mg/100g) to toxic content ( $> 50$  mg/kg). Content of readily available  $K_2O$  fell within the interval from poor (5-10 mg/100g) to high level (25-50 mg/100g). None of the analysed samples exceeded MAC for agricultural soils regarding the content of trace elements (Cu, Zn, As, Pb, Cd, Ni, and Cr). Analysed agricultural soils are suitable for safe food production. Farmers do not apply rational doses of mineral fertilizers. Excessive use of mineral fertilizers might affect the urban environment, which indicates the necessity for a broader training of farmers regarding optimal fertilizer doses.

## ACKNOWLEDGEMENTS

This study is a result of the research carried out under the projects based on the Common Terms Agreement between the Municipality Government of Novi Sad as the financing party and Institute of Field and Vegetable Crops as the project company.

## REFERENCES

- Abdulkadir, A., Leffelaar, P.A., Agbenin, J.O., Giller, K.E. (2013). Nutrient flows and balances in urban and peri-urban agroecosystems of Kano, Nigeria. *Nutrient Cycling in Agroecosystems*, 95, 231–254.
- Antisari, L.V., Orsini, F., Marchetti, L., Vianello, G., Gianquinto, G. (2015). Heavy metal accumulation in vegetables grown in urban gardens. *Agronomy for Sustainable Development*, 35, 1139–1147.
- Boim, A.G.F., Melo, L.C.A., Moreno, F.N., Alleoni, L.R.F. (2016). Bioconcentration factors and the risk concentrations of potentially toxic elements in garden soils. *Journal of Environmental Management*, 170, 21–27.

- Cheng, Z., McCoy, E.L., Grewal, P.S. (2014). Water, sediment, and nutrient runoff from urban lawns established on disturbed subsoil or topsoil and managed with inorganic or organic fertilizers. *Urban Ecosystems*, 17, 277–289.
- Davies, B.E. (1995). Lead. In: Alloway, B.J. (ed.) *Heavy Metals in Soils*, Blackie and Son Ltd.
- De Bon, H., Parrot, L., Moustier, P. (2010). Sustainable urban agriculture in developing countries, A review. *Agronomy for Sustainable Development*, 30, 21–32.
- Dozet, D.D., Nešić, Lj., Belić, M., Bogdanović, D., Ninkov, J., Zeremski, T., Dozet, D., Banjac, B. (2011). Origin and Content of Nickel in Alluvial-Diluvial Soils of Srem, Serbia. *Ratar. Povrt.*, 48(2), 369–374.
- Egner, H., Riehm, H. (1955). Die Untersuchung von Böden. In: Thun R, Herrmann R, Knickmann E (Eds.), *Neumann Verlag Radebeul/Berlin, Germany*, 110–125.
- Eigenbrod, C. and Gruda, N. (2015). Urban vegetable for food security in cities, A review. *Agronomy for Sustainable Development*, 35, 483–498.
- FAO Committee on Agriculture (1997). 15th Session COAG/99/10, X0076 Urban and Peri-Urban Agriculture. <http://www.fao.org/unfao/bodies/coag/coag15/X0076e.htm>
- Gregory, M.M., Leslie, T.W., Drinkwater, L.E. (2015). Agroecological and social characteristics of New York city community gardens: contributions to urban food security, ecosystem services, and environmental education. *Urban Ecosystems*, DOI: 10.1007/s11252-015-0505-1
- Houskova, B., Montanarella, L. (2006). Parent material as a source of natural background values in soils. *European Commission, Joint Research Centre*.
- Jim, C.Y. (1998). Physical and chemical properties of a Hong Kong roadside soil in relation to urban tree growth. *Urban Ecosystems*, 2, 171–181.
- Joimel, S., Cortet, J., Jolivet, C.C., Saby, N.P.A., Chenot, E.D., Branchu, P., Consalès, J.N., Lefort, C., Morel, J.L., Schwartz, C. (2016). Physico-chemical characteristics of topsoil for contrasted forest, agricultural, urban and industrial land uses in France. *Science of the Total Environment*, 545–546, 40–47.
- Kastori, R. (1993). Teški metali i pesticidi u zemljištu Vojvodine, Poljoprivredni fakultet Novi Sad, Institut za ratarstvo i povrtarstvo, Novi Sad.
- Mihailović, A., Budinski-Petković, Lj., Popov, S., Ninkov, J., Vasin, J., Ralević, N.M., Vučinić Vasić, M. (2015). Spatial distribution of metals in urban soil of Novi Sad, Serbia: GIS based approach. *Journal of Geochemical Exploration*, 150, 104–114.
- Milić, S., Vasin, J., Ninkov, J., Zeremski, T., Brunet, B., Sekulić, P. (2011). Fertility of privately owned plowland used for field crop production in Vojvodina, Serbia. *Ratar. Povrt.*, 48(2), 359–368.
- Murray, H., Pinchin, T.A., Macfie, S.M. (2011). Compost application affects metal uptake in plants grown in urban garden soils and potential human health risk. *Journal of Soils and Sediments*, 11, 815–829.
- Ninkov, J., Papić, Đ., Sekulić, P., Zeremski-Škorić, T., Milić, S., Vasin, J., Kurjački, I. (2012). Copper content of vineyard soils at Sremski Karlovci (Vojvodina Province, Serbia) as affected by the use of copper-based fungicides. *International Journal of Environmental Analytical Chemistry*, 92(5), 592–600.
- Orsini, F., Kahane, R., Nono-Womdim, R., Gianquinto, G. (2013). Urban agriculture in the developing world, A review. *Agronomy for Sustainable Development*, 33, 695–720.
- Pfeifer, L.R., Bennett, E.M. (2011). Environmental and social predictors of phosphorus in urban streams on the Island of Montréal, Québec. *Urban Ecosystems*, 14, 485–499.
- Ralev, J., Pucarević, M., Vasin, J. (2003). Kvalitet zemljišta za organsku proizvodnju povrća u Vojvodini. *Arhiv za poljoprivredne nauke*, 64 (227-228) (2003/3-4), 179–185.
- Regulation on permitted amounts of hazardous and noxious substances in soil and irrigation water and methods of their testing. *Serbian Official Gazette*, RS 23/1994.
- Sekulić, P., Ninkov, J., Zeremski-Škorić, T., Vasin, J., Milić, S., Lazić, N., Vujić, B. (2011). Monitoring quality of Vojvodina soils. *JRC Scientific and Technical Reports, EUR 24889 EN-2011: Soil Protection Activities and Soil Quality Monitoring in South Eastern Europe*, 119-126.
- Sharma, K., Basta, N.T., Grewal, P.S. (2015). Soil heavy metal contamination in residential neighborhoods in post-industrial cities and its potential human exposure risk. *Urban Ecosystems*, 18, 115–132.
- Škrbić, B., Đurišić-Mladenović, N. (2013). Distribution of heavy elements in urban and rural surface soils: the Novi Sad city and the surrounding settlements, Serbia. *Environmental Monitoring and Assessment*, 185, 457–471.
- Trammell, T.L.E., Schneid, B.P., Carreiro, M.M. (2011). Forest soils adjacent to urban interstates: Soil physical and chemical properties, heavy metals, disturbance legacies, and relationships with woody vegetation. *Urban Ecosystems*, 14, 525–552.
- Witzling, L., Wander, M., Phillips, E. (2011). Testing and educating on urban soil lead: A case of Chicago community gardens. *Journal of Agriculture, Food Systems and Community Development*, DOI:10.5304/jafscd.2010.012.015
- Yesilonis, I.D., Pouyat, R.V., Russell-Anelli, J., Powell, E. (2016). The effects of landscape cover on surface soils in a low density residential neighborhood in Baltimore, Maryland. *Urban Ecosystems*, 19, 115–129.



## **CLIMATE CHANGES AND URBAN POLLUTION**

V International Conference  
„ECOLOGY OF URBAN AREAS“ 2016

## PROTECTION FROM CLIMATE CHANGES IN THE REPUBLIC OF SERBIA AND INTERNATIONAL LAW

Nadezda Ljubojev\*, Bogdana Vujic, Dragica Ivin

University of Novi Sad, Technical Faculty “Mihajlo Pupin” Zrenjanin  
nadezdaljubojev@gmail.com, bogdana.vujic@tfzr.rs, divin@tfzr.uns.ac.rs

### ABSTRACT

In recent decades climate changes take great attention of the scientific and political world public. Great effort has been invested in the creation of policies that will affect the reduction and mitigation of climate change. The authors in this paper present the most important international and EU regulations in the field of climate changes as one specific issue within environmental protection. Special attention is focused on legislations and policy of Republic of Serbia related to this field and studying the level of harmonization of Serbian regulations on climate changes with European legislation. Accordingly, the subject of this paper includes the discussion of legal framework important for the protection from climate changes both at global level and within the Republic of Serbia. Moreover, there is a need for further harmonization of Serbian legislation with world trends in the field of climate changes as well as with obligations arising from ratified international documents and the Process of European Integration

**Key words:** climate changes, legal protection, policy, EU, The Republic of Serbia.

### INTRODUCTION

Climate change is one of the greatest environmental, social and economic threats. There are numerous scientific evidences that the climate has changed during the whole history of our planet. However, the data from the last several decades on average annual temperatures are signaling that the situation is alarming – until 2012 the temperature was for 0.8°C higher comparing to pre-industrial period but in the last 30 years the average global temperatures have been increased from 0.1 °C per decade to 0.2 °C per decade. (IPPC, 2014)

Temperatures in Europe have been increased faster than the global average in the last 50 years. The average annual temperature increase is 1,4° C. Unfortunately, projections for the end of 21<sup>st</sup> century show an annual temperature increase from 2,1° C to 4,4° C whereas the most significant rise is expected during summer periods. In South Europe the increase can locally go up to 6°C (IPCC, 2007).

Logically, global climate changes are also reflected to the area of the Republic of Serbia, so according to National hydro-meteorological service a positive trend of temperatures was observed (Popovic, 2007; Popovic et al., 2008; Popovic, et al., 2009). According to the data from the Ministry of Environmental Protection and Planning, the increase is up to 0.04° C per year, while in some areas in the east and south-east of the country a negative trend up to -0.05° C per year was recorded. The biggest temperature rise was recorded in autumn (MEPUP, 2010).

### Climate Change Facts

Several notions should be defined for better understanding of climate changes:

1. “**Climate system**” is complex system consisting of five major components: atmosphere, hydrosphere, lithosphere, cryosphere and biosphere. Between these components there are many physical, chemical and biological interactions making it a dynamic system.
2. The state of the climate system that includes statistical description of its variations in period from few months to few millions of years is defined as “**Climate**” (Baede at al., 2001)

Variables describing climate consider average, maximum and minimum temperature, wind near the surface of the Earth, precipitation in its various forms, humidity, cloud type and amount, and solar radiation.

3. **“Climate changes”** are statistically significant changes of climate parameters that last during a longer period of time (several decades or longer). The changes of variables are induced by external forcing influencing the radiative balance of the Earth which may be natural: solar radiation or volcanic eruptions or antropogenic: emission of greenhouse gases or land-use change etc.

Since the atmosphere is one of the most unstable components of the climate system that is apt to fast changes because of the air mass movement, a great attention is paid to temperature changes in the atmosphere caused by natural or antropogenic factors. However, in the last several decades the notion of **climate changes** is related to the changes caused by the presence of Greenhouse gases (GHG) whose presence is exclusively connected to human activities. Greenhouse gases: carbon-dioxide (CO<sub>2</sub>), methane (CH<sub>4</sub>), nitrous oxide (N<sub>2</sub>O), hydrofluorocarbons (HFCs), perfluorocarbons (PFCs), Sulphur hexafluoride (SF<sub>6</sub>) (United Nations (UN), 1998) as well as the chlorofluorocarbons (CFCs), the hydro chlorofluorocarbons (HCFCs), and the halons (United Nations Environment Programme (UNEP, 1987), absorb and re-emit heat, and thereby keep the planet’s atmosphere warmer than it otherwise would be.

According to International Panel of Climate Changes (IPCC), the biggest source of GHG is electricity and heat production with participation of 25% in total emissions of GHG, then Agriculture, Forestry and Other Land Use (AFOLU) with 24%, Industry with 21%, Transport with 14%, Buildings with 6.4%, and Other Energy which refers to all GHG emission sources in the energy sector other than electricity and heat production with 9,6%. (see also Figure 1).

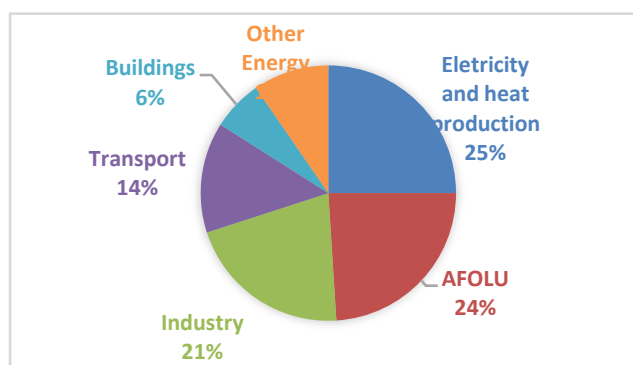

Figure 1 Total GHG emission expressed in Gt CO<sub>2</sub>-eq/t \* in 2010 (IPCC, 2014).

\*CO<sub>2</sub> is the most important GHG gas, so total emission of GHG is expressed in equivalent amount of CO<sub>2</sub> (Gt) CO<sub>2</sub>eq/year which signifies the amount of CO<sub>2</sub> which would have the equivalent global warming impact. (IPCC,2014).

Concentration of CO<sub>2</sub> in the atmosphere has been constantly increased since the Industrial Revolution. The emission of CO<sub>2</sub> has increased from 910 GtCO<sub>2</sub> during the period from 1750 to 1970, to 2000 GtCO<sub>2</sub> in the period from 1740 to 2010. Noticeable increase was recorded from 2000 to 2010. During this period the emission of GHG was increased in average for 1 GtCO<sub>2</sub>eq/year, while for the period from 1970 to 2000 the increase was 0.4 GtCO<sub>2</sub>eq/year. (IPCC,2014).

The calculation of GHG emission in the Republic of Serbia was made for the basic years 1990 and 1998. According to this calculation the amount of GHG emission (in Gg CO<sub>2</sub>eq) for 1990 was 80.803 Gg CO<sub>2</sub>eq, and for 1998 it was 66.346 Gg CO<sub>2</sub>eq, excluding Land use, land-use change and forestry (LULUCF) (MEPUP, 2010).

A participation of individual sectors in total emissions for 1990 and 1998 are presented in the Figure of the Ministry for Environmental Protection and Planning (see also Figure 2).

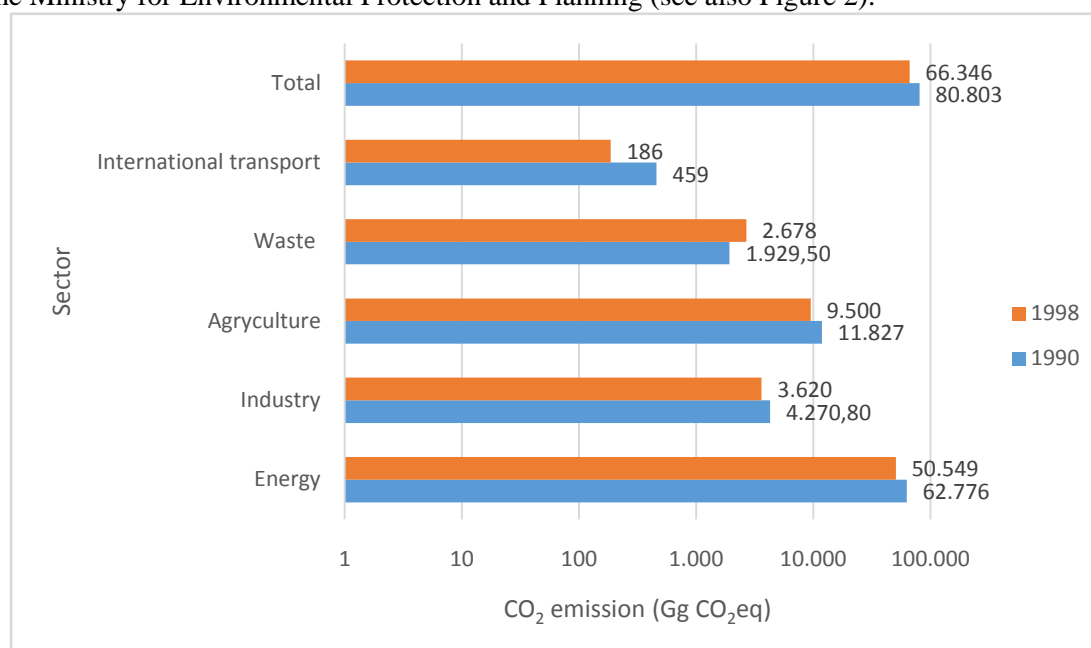

Figure 2. Participation of individual sectors in total emissions for 1990 and 1998 (MEPUP, 2010)

Although in comparison to 1990, in 1998 the total emission of CO<sub>2</sub> was reduced -21,8% for the majority of sectors, (Energy sector: -24,19%; Industry: -18%; Agriculture: -24,5%; ), with an exception of Waste Management where an increase was recorded, +27,9%, it must be said that in this period, due to economic sanctions and therefore unfavorable economic situation, economic activity was poor which also resulted in reduced emission of GHG (MEPUP, 2010).

However, the consequences of climate changes affect the other components of climate system causing different consequences such as acidification. Climate change impacts our health, environment, and economy.

## LEGAL FRAMEWORK FOR THE PROTECTION FROM CLIMATE CHANGES

### International Legal Framework

The United Nations (UN) have crucial role in solving the issues of climate changes. The first step is The United Nations Framework Convention on Climate Change (UNFCCC) adopted and signed at the Earth Summit in Rio de Janeiro, Brazil, in June 1992. This Convention entered into force in March 1994 and by now 195 countries have ratified the Convention forming the Parties to the Convention.

UN Convention on Climate Change is significant, and the objective of its rendering was to achieve the stabilization of greenhouse gases concentrations in the atmosphere to a level which would prevent dangerous anthropogenic influences to the climate system. In addition to UNFCCC, the Kyoto Protocol was adopted in Kyoto, Japan, in December 1997 to improve the implementation of the Convention. The Kyoto Protocol represents a significant step towards limiting the emission of 6 greenhouse gases: carbon dioxide (CO), methane (CH), nitrous oxide (NO), hydrofluorocarbons (HFCs), perfluorocarbons (PFCs), sulfur hexafluoride (SF<sub>6</sub>). With the objective of moderating global climate changes this protocol, where numerous different gases which cause atmosphere pollution were specified, was adopted. Carbon dioxide was singled out as a gas which singularly contributes the most to the greenhouse effect which participates around 60 % in the complete amount of all released gases. Commitments of developed countries are specially defined. Provisions of the protocol require from developed countries to restrict the emission of harmful gases below the levels which existed prior to 1990. These emissions were supposed to be cut down between 2008 and 2012, by around 5%. During

this period countries of the European Union were supposed to cut down by 6%, USA by 7%, Japan by 6%, etc. At a conference in Kyoto it has been assessed that economic instruments have significant effect in restricting emissions of harmful gases and that they are more efficient than administrative instruments. The particularity of the Kyoto Protocol is also in the fact that it has established three basic mechanisms for the realization of established objectives. Those are: joint implementation – JI (Art. 6), clean development mechanism CDM (Article 12) and emissions trading – ET (Article 17).

The leading international organization in the field of climate changes is International Panel of Climate Changes (IPCC), founded in 1988 within United Nations Environment Programme (UNEP) and World Meteorological Organization (WMO). IPCC is a scientific organization which should give scientific data on global climate changes. One of the basic activities of IPCC is the creation of a report on global climate changes based on a thorough analysis of all significant scientific documents on global level.

The 2015 United Nations Climate Change Conference, COP 21 or CMP 11 was held in Paris, France, from 30 November to 12 December 2015. It was the 21st yearly session of the Conference of the Parties (COP) to the 1992 UNFCCC and the 11th session of the Meeting of the Parties to the 1997 Kyoto Protocol. The conference negotiated the Paris Agreement, a global agreement on the reduction of climate change, the text of which represented a consensus of the representatives of the 196 parties attending it. It was opened for signature on 22 April 2016 (Earth Day) in a ceremony in New York City.

Paris Climate Agreement defines obligations of all state members for the period after 2020. This Agreement precisely defines the obligation of performing activities on greenhouse gas emission that will secure the limitation of global average temperature increase significantly under 20 degrees with a positive tendency that will gradually lead to the limitation of global average temperature to 1,50 degrees. The obligations of individual state members of the Convention and within this Agreement are determined by the objectives of greenhouse gas emission reduction which the states sent as a preparation for the Conference. Serbia sent its reduction gas emission objective for 2030 in relation to 1990, which is 9.8 %.

Paris Climate Agreement asks for increasing ambition and making strategies for long-term reducing greenhouse gas emission. It will be performed through review of the sent objectives every 5 years according to possibilities of each country. Besides mitigation, Paris Climate Agreement involves other key issues, including adaptation to the changed climate conditions, financing of mitigation and adaptation in developing countries, as well as capacity strengthening and development and transfer of technologies. In this context, it is important that the Agreement clearly defines the need for financial help of developed countries towards developing countries so as to fulfill their objectives and obligations defined by the Agreement.

Paris Climate Agreement will be enforced after its ratification by at least 55 countries whose gas emission is 55 % of the total world harmful gas emission. Until today Paris Climate Agreement has been ratified by 28 out of 180 countries which signed it. It is of great importance that China and USA are among the countries which ratified the Agreement.

### **The Climate Changes in the Legislation of the European Union**

Nowadays, ecological policy of European Union (EU) takes an important place in the activities of EU. In that direction the necessity of establishing European standards towards environment protection and improvement of environment quality, preservation of human health and ensuring the rational use of natural resources has been agreed on.

With regard to the importance of climate changes, this question is regulated in the legislation of EU. It is necessary to present the review of the most important legal acts of EU in the area of climate changes. Since 2007, EU has regulated the fields of climate and energy through „EU Climate and

Energy Package“ which includes the set of obligatory legal documents from this field. The important strategic EU document in this field is the „Map for achieving competitive low-carbon economy until 2050 “.

### ***The 2020 Climate and Energy Package***

The 2020 Climate and Energy Package set three key objectives for the EU by 2020: a 20% reduction in greenhouse gas emissions from 1990 levels, raising the share of energy consumption produced from renewable resources to 20% and 20% improvement in the energy efficiency. The targets were set by EU leaders in March 2007, when they committed Europe to become a highly energy-efficient, low carbon economy, and were enacted through the climate and energy package in 2009.

The climate and energy package comprises four pieces of complementary legislation. First, the EU ETS is the key tool for cutting industrial greenhouse gas emissions most cost-effectively. The climate and energy package includes a comprehensive revision and strengthening of the legislation which underpins the EU ETS, the Emissions Trading Directive. Major changes include the introduction of a single EU-wide cap on emission allowances in place of the existing system of national caps. The cap will be cut each year so that by 2020 emissions will be 21 percent below the 2005 level. Under the so-called Effort Sharing Decision, Member States have taken on binding annual targets for reducing their greenhouse gas emissions from the sectors not covered by the EU ETS, such as housing, agriculture, waste and transport – comprising around 60 % of the EU's total emissions. The national targets range from a 20 % emissions reduction by the richest Member States to a 20 % increase by the least wealthy. Member States must report on their emissions annually under the EU monitoring mechanism. Under the Renewable Energy Directive, Member States have taken on binding national targets for raising the share of renewable energy in their energy consumption by 2020. The national targets ranging from 10-49 % will enable the EU as a whole to reach its 20 % renewable energy target for 2020. In addition, the targets will also help to cut greenhouse gas emissions and reduce the EU's dependence on imported energy. The fourth element of the climate and energy package is a directive creating a legal framework for the environmentally safe use of carbon capture and storage technologies, which involves capturing the carbon dioxide emitted by industrial processes and storing it in underground geological formations where it does not contribute to global warming. The climate and energy package does not directly address the energy efficiency target. This is being done through the 2011 Energy Efficiency Plan.

### **The EU's 2030 Climate and Energy Goals**

In October 2014, EU leaders agreed about the 2030 policy framework for climate and energy, which aims to make the European Union's economy and energy system more secure and sustainable and will drive continued progress towards a low-carbon economy. The main targets of the 2030 framework are: reducing greenhouse gas emissions by at least 40 %, increasing the share of renewable energy to at least 27 % and increasing energy efficiency by at least 27 %. The main goal of the framework is the binding target to reduce EU domestic greenhouse gas emissions by at least 40 % below the 1990 level by 2030. The European Council approved a binding target of increasing the share of renewable energy to at least 27 % of the EU's energy consumption by 2030, and increasing energy efficiency by at least 27%.

### **2050 Roadmap to Low-Carbon Economy**

By 2050, the EU could cut most of its greenhouse gas emissions. The 2050 Roadmap is one of the long-term policy plans intended to put the EU on course to using resources in a sustainable way. Clean technologies are in the center of the future for Europe's economy. The Roadmap suggests that, by 2050, the EU should cut its emissions to 80 % below 1990 levels through domestic reductions. It sets out a cost-effective pathway to this goal with reduction milestones of 40 % by 2030 and 60 % by

2040. For the short term, the EU has put in place legislation to reduce its emissions to 20 % below 1990 levels by 2020 (ec.europa.eu).

Table 1. Sector perspective (ec.europa.eu)

GHG reduction compared to 1990.	2005	2030	2050
<b>Total</b>	<b>-7%</b>	<b>-40 to -44%</b>	<b>-79 to -82%</b>
<b>Sectors</b>			
Energy (CO <sub>2</sub> )	-7%	-54 to -68%	-93 to -99%
Industry (CO <sub>2</sub> )	-20%	-34 to -40%	-83 to -87%
Transport (incl. CO <sub>2</sub> aviation, excl. maritime)	+30%	+20 to -9%	-54 to -67%
Housing and Services (CO <sub>2</sub> )	-12%	-37 to -53%	-88 to -91%
Agriculture (non-CO <sub>2</sub> )	-20%	-36 to -37%	-42 to -49%
Other non-CO <sub>2</sub> emissions	-30%	-72 to -73%	-70 to -78%

The Roadmap to a low-carbon economy shows how the effort of reducing greenhouse gas emissions should be divided cost-effectively between different economic sectors according to their technological and economic potential. (see also Table 2).

The transition to a low-carbon society will be based on the increased innovation and investment in clean technologies and low- or zero-carbon energy. Energy efficiency will be a key driver of the transition, as the EU could be using around 30 % less energy in 2050 than in 2005. Greater use of clean technologies will drastically reduce air pollution in European cities.

### EU Emissions Trading System

The EU emissions trading system (EU ETS) is a key tool for reducing EU's industrial greenhouse gas emissions cost-effectively. The EU ETS works on the 'cap and trade' principle. A 'cap', or limit, is set on the total amount of certain greenhouse gases that can be emitted by the factories, power plants and other installations in the system. The cap is reduced over time so that total emissions fall. Within the cap, companies receive or buy emission allowances which they can trade with one another as needed. They can also buy limited amounts of international credits from emission-saving projects. After each year a company must surrender enough allowances to cover all its emissions, otherwise heavy fines are imposed. If a company reduces its emissions, it can keep the spare allowances to cover its future needs or else sell them to another company.

While emissions trading has the potential to cover many economic sectors and greenhouse gases, the focus of the EU ETS is on emissions which can be measured, reported and verified with a high level of accuracy. Greenhouse gases and sectors included: Carbon dioxide (CO<sub>2</sub>), from power and heat generation, energy-intensive industry sectors including oil refineries, steel works and production of iron, aluminium, metals, cement, lime, glass, ceramics, pulp, paper, cardboard, acids and bulk organic chemicals, commercial aviation, Nitrous oxide (N<sub>2</sub>O) from production of nitric, adipic, glyoxal and glyoxalic acids, Perfluorocarbons (PFCs) from aluminium production. Participation in the EU ETS is mandatory for companies operating in these sectors, but in some sectors only plants above a certain size are included.

The EU ETS is now in its third phase, running from 2013 to 2020 with significant changes from the previous phase in order to strengthen the system.

By putting a price on carbon and thereby giving a financial value to each ton of emissions saved, the EU ETS has placed climate change on the company's financial agenda. A sufficiently high carbon price also promotes investment in clean, low-carbon technologies.

As Parties to the UNFCCC, the EU and its Member States are required to report annually on their GHG emissions. In addition to GHG inventories, countries have to report regularly on their climate change policies and measures. The annual EU GHG inventory report is prepared by the European Environment Agency each spring.

Regarding the emission trading system in Serbia, in the framework of Serbia's accession to the EU and to get support for the implementation of the Emission Trading Directive, Serbia has launched an EU Twinning project on the "Creation of a Monitoring, Reporting and Verifying System for the Successful Implementation of the EU Emissions Trading System". The project aims to accelerate harmonization with and implementation of the establishment of the EU Emission Trading System (EU ETS) in Serbia. The project is implemented by the French Ministry of Ecology, Sustainable Development and Energy, German Federal Ministry for Environmental, Nature Conservation and Nuclear Safety and Austrian Environment Agency.

### **Protection from Climate Changes in the Legislation of the Republic of Serbia**

The Government of Serbia ratified the UNFCCC in 2001 and the Kyoto Protocol in 2008, and has made the steps in establishing legal, institutional and policy frameworks aiming to fulfill the commitments outlined under the Convention and the Protocol.

Being part of the developing country group "Non-Annex I countries" under the UNFCCC, the Republic of Serbia did not have quantitative greenhouse gases emission reduction commitments in the first commitment period. However, the Republic of Serbia has all the commitments with regards to establishing and implementing measures and activities to achieve the objectives of the Convention.

The second commitment period of the Kyoto Protocol was launched when the Doha Amendment to the Kyoto Protocol was adopted in Doha, Qatar, in December 2012. During the second commitment period, Parties committed to reduce GHG emissions by at least 18 percent below the 1990 levels in the eight-year period from 2013 to 2020. However, the Doha Amendment has not yet entered into force.

Being a non-Annex I country under the UNFCCC, the Republic of Serbia can use the Clean Development Mechanism (CDM). In accordance with obligations, National Designated Authority for implementation of CDM under Kyoto Protocol (DNA) has been established. So far, seven CDM Projects have been registered in Serbia. Besides that, following development of new options for climate change mitigation under the Convention, Serbia prepared Nationally Appropriate Mitigation Actions (NAMAs). Concept of NAMAs, represents one of the key components of climate change mitigation at international level. This concept integrates policies and concrete actions of developing countries directed towards GHG emission reductions, in compliance with national circumstances and differentiated responsibilities. Serbia has developed 12 NAMA projects so far and submitted them to the NAMA Registry of the Convention Secretariat. The purpose of NAMA Registry is to keep record of NAMA projects in terms of providing available financial assistance, technology transfer and capacity building, as well as to recognize them.

The Government of Serbia compiled the "National Strategy for Incorporation of the Republic of Serbia into Clean Development Mechanism" in 2010.

The Initial National Communication (INC) of the Republic of Serbia was adopted and published in 2010. The report highlighted a number of issues recognizing the energy sector as the main contributor to GHG emissions in Serbia and also likely the sector with the greatest potential for mitigation. The



Government of Serbia is preparing the Second National Communication and First Biennial Update Report.

The establishment of a reporting cycle to UNFCCC has important implications for strengthening Serbia's technical and institutional capacity in the area of climate change. Serbia is facing a number of significant constraints, such as the lack of capacities and a complete operational system for monitoring, reporting and verification (MRV) of climate change-related activities.

### *The obligations of Serbia towards EU in the field of climate changes*

Within Serbian obligations towards EU in the field of climate changes further harmonization with EU policies is necessary, such as objectives 2020 and requirements related to monitoring and making reports. According to this the priority ought to be the establishment of the system for monitoring, reporting and verification (MRV) of greenhouse gases emission. Therefore, the Republic of Serbia initiated and performs the following IPA projects and activities: "Creation of a Monitoring, Reporting and Verification System for the Successful Implementation of the EU Emissions Trading System (EU ETS) in the Republic of Serbia (IPA, 2012)", "Establishment of the Mechanism for Implementation of MMR" (IPA, 2013) and "Development of the Climate Change Strategy with an Action Plan (IPA 2014)".

## **CONCLUSION**

Climate change is a reality that is reflected in all aspects of life and brings into question the survival of plant and animal species.

Climate change is a reality faced by mankind and is a problem that requires immediate action and long-term sustainable solutions. Serbia has ratified the UNFCCC in 2001 and the Kyoto Protocol in 2008, as a non-Annex I Party. As a non-Annex I Party to the UNFCCC, Serbia has no commitments on the reductions of GHG emissions but in accordance with the Article 12 of Convention, each Party shall provide the Conference of the Parties (COP) with the information on national greenhouse gas inventories; national or, where appropriate, regional programmes containing measures to mitigate, and to facilitate adequate adaptation to climate change; and any other information that the Party considers relevant to achieving the objective of the Convention, as well as to integrate climate change into the broader development planning process of the country.

The Initial National Communication (INC) of the Republic of Serbia, as an important national strategic document, was adopted and published in 2010, and highlighted a number of issues, recognizing the energy sector as the main contributor to GHG emissions in Serbia and also likely the sector with the greatest potential for mitigation.

Since the ratification and application of the UNFCCC and the Kyoto Protocol, in the Republic of Serbia considerable efforts have been made in establishing legal, institutional and policy frameworks aiming to fulfill the commitments outlined under the Convention and the Protocol. While the first set of environmental laws designed to combat climate change was adopted in 2004, considerable progress has been achieved with the beginning of the process of EU accession and the harmonization of national legislation with that of the EU.

Within the obligations of Serbia towards EU in the field of climate changes further harmonization with EU policies is necessary, such as the objectives 2020 and requirements related to monitoring and making reports. In relation to this issue the priority ought to be the establishment of the system for monitoring, reporting and verification (MRV) of greenhouse gas emission.

## **REFERENCES**

Baede A.P.M., Ahlonsou, E., Ding, Y., Schimel, D. (2001) The Climate System: an Overview In: Climate Change 2001: The Scientific Basis. Contribution of Working Group I to the Third Assessment Report of

- the Intergovernmental Panel on Climate Change [Houghton, J.T., Y. Ding, D.J. Griggs, M. Noguer, P.J. van der Linden, X. Dai, K. Maskell, and C.A. Johnson (eds.)]. Cambridge University Press, Cambridge, United Kingdom and New York, NY, USA, 881. On line: <http://www.ipcc.ch/ipccreports/tar/wg1/index.htm> (Accessed August 2015.)
- Communication from the Commission to the European Parliament, the Council, The European Economic and Social Committee and the Committee of the Regions a *Roadmap for Moving to a Competitive Low Carbon Economy in 2050*, Document 52011DC0112. <http://eur-lex.europa.eu/legal-content/EN/ALL/?uri=celex%3A52011DC0112>. (Accessed August 2016).
- Council Decision 94/69/EC of 15 December 1993 concerning the conclusion of the United Nations Framework Convention on Climate Change, OJ L 33, 7.2.1994, 11–12, <http://eur-lex.europa.eu/legal-content/EN/TXT/?uri=celex:31994D0069>
- Council Decision 2002/358/EC of 25 April 2002 concerning the approval, on behalf of the European Community, of the Kyoto Protocol to the United Nations Framework Convention on Climate Change and the joint fulfillment of commitments thereunder, OJ L 130, 15.5.2002, 1–3. <http://eur-lex.europa.eu/legal-content/EN/TXT/?uri=celex%3A32002D0358>.
- IPCC (2014). Climate Change 2014: Synthesis Report. Contribution of Working Groups I, II and III to the Fifth Assessment Report of the Intergovernmental Panel on Climate Change [Core Writing Team, R.K. Pachauri and L.A. Meyer (eds.)]. IPCC, Geneva, Switzerland, 151. On line: [http://www.ipcc.ch/pdf/assessment-report/ar5/syr/SYR\\_AR5\\_FINAL\\_full\\_wcover.pdf](http://www.ipcc.ch/pdf/assessment-report/ar5/syr/SYR_AR5_FINAL_full_wcover.pdf), (Accessed August 2016.)
- IPCC (2007). Climate Change 2007: Synthesis Report. Contribution of Working Groups I, II and III to the Fourth Assessment Report of the Intergovernmental Panel on Climate Change [Pachauri, R. K and Reisinger, A. (eds)]. IPCC, Geneva, Switzerland, 104.
- Law on Ratification of Kyoto Protocol to the UN Framework Convention on Climate Change, 1997, *Official Gazette of RS - International Treaties*, Vol. 88/07.
- MEPUP, (2010). Ministry for Environmental Protection and Urban Planning, First Report of Republic of Serbia according to the Framework Directive UN on climate changes [http://www.klimatskepromene.rs/uploads/useruploads/Documents/Prvi-izvestaj\\_srp\\_web](http://www.klimatskepromene.rs/uploads/useruploads/Documents/Prvi-izvestaj_srp_web) [1].pdf, (Accessed August 2016).
- Popovic, T. (2007). Trend Changes in Air Temperature and Quantity of the Republic of Serbia, *Forests and Climate Change*, Faculty of Forestry, Belgrade, 81 -123.
- Popovic, T., Zivkovic, M., Radulovic E. (2008). Serbia and Global Warming, *I Sustainable Conference Development and Climate Change*, 47-54.
- Popovic, T., Djurdjevic, V., Zivkovic, M., Jovic, B., Jovanovic, M. (2009). Climate Change in Serbia and the Expected Impacts EnE09, Proceedings of 5th Regional Conference *Environment for Europe*, Belgrade, Serbia, 4-5 Jun 2009, 6-11, ISBN 978-86-910873-2 6.
- Serbia and Climate Change <http://www.klimatskepromene.rs/unfccc>.
- UN (1998), Kyoto Protocol To The United Nations Framework Convention On Climate Change <http://unfccc.int/resource/docs/convkp/kpeng.pdf> (Accessed August 2016)
- UNEP (1987), Montreal Protocol on Substances that Deplete the Ozone Layer, <http://ozone.unep.org/en/handbook-montreal-protocol-substances-deplete-ozone-layer/25415> (Accessed August 2016)

**ECONOMICS OF SUSTAINABLE DEVELOPMENT OF  
URBAN AREAS**

V International Conference  
„ECOLOGY OF URBAN AREAS“ 2016

## STATISTICAL ANALYSIS FOR BIOGAS PRODUCTION FROM TWO DIFFERENT BATCHES UNDER THE SAME CONDITIONS

Gavrilă Trif-Tordai<sup>1</sup>, Adrian Eugen Cioabla<sup>1</sup>, Delia-Gabriela Calinoiu<sup>2\*</sup>

<sup>1</sup>University Politehnica Timisoara, Faculty of Mechanical Engineering, Timisoara, Romania

<sup>2</sup>University Politehnica Timisoara, Department of Fundamental of Physics for Engineers, Timisoara, Romania  
gavrila.trif-tordai@upt.ro, adrian.cioabla@upt.ro, delia.calinoiu@upt.ro\*

### ABSTRACT

*The paper focuses on statistical analysis made on the amount of biogas resulted from the anaerobic fermentation. The types of agricultural biomass used, in the biogas pilot plant at Politehnica University Timisoara, are: i) reactor 1 - degraded corncob and wastewater from treatment plants, ii) reactor 2 - degraded wheat grains and wastewater from treatment plant. The fermentation process was monitored for 41 days, recording the following parameters for the two reactors: pressure, pH, temperature and biogas production. Various statistics, including correlations, covariance, and partial correlations were calculate. Also included in the procedure are a number of multivariate graphs, which give interesting views into the data.*

**Keywords:** Biogas, anaerobic fermentation, statistical analysis.

### INTRODUCTION

Biogas can be used to generate electricity, heat and biofuels, while the secondary product, the fermentation residue (digestate) can be used as fertilizer. In their utilization, biogas and digestate are of equal importance in energy production, and they also make a significant contribution to systemic greenhouse gas (GHG) mitigation by recycling household and agricultural waste.

In the same time, anaerobic co-digestion is reported to offer several benefits over digestion of separate materials, such as increased cost-efficiency (one plant for several materials), increased degradation of the treated materials due to synergistic effects, more optimal moisture and nutrient content and dilution of inhibitive compounds, such as ammonia and degradation products of lipids, as well as increased biogas production (Elango et al., 2007).

The modern biomass technologies lead to efficient biomass conversion, being one possible direction for biomass use in developing countries like Romania (Cioabla et al., 2016).

### EXPERIMENTAL SETUP

The pilot plant used for producing biogas from biomass through anaerobic fermentation is presented in Figure 1 and is based on an original design described in Cioabla, 2009; Savprod SA., Politehnica University of Timisoara, 2007.

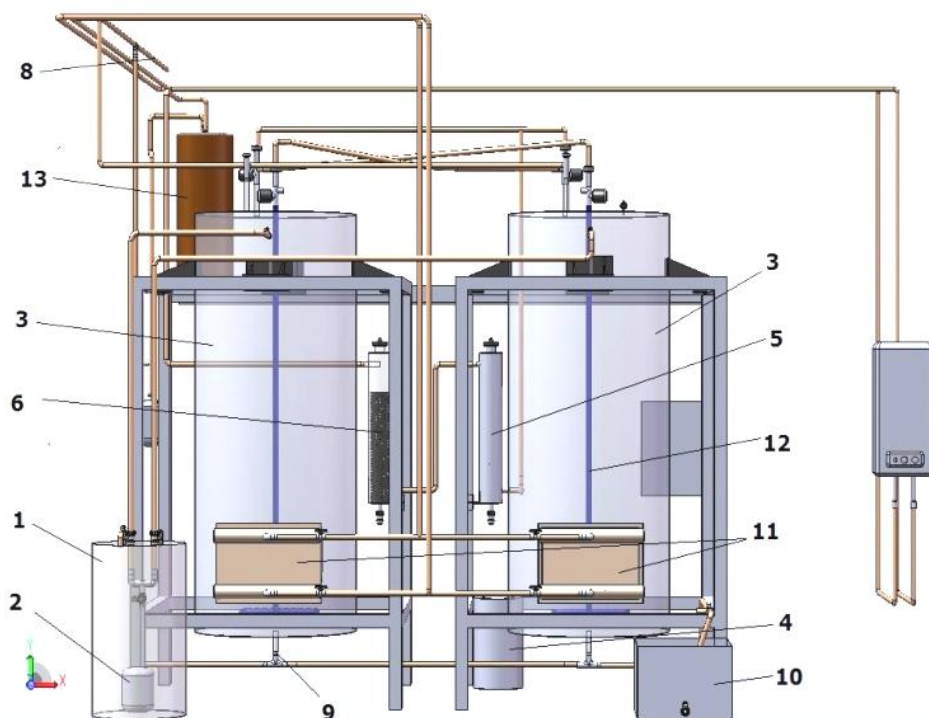

Figure 1. Schematic configuration of biogas pilot plant

From the biomass deposit, the used material is passed through a mill, and then it is sent to the tank where the preparation of the suspension of biomass is made (1). The biomass suspension is transported with the help of the pump (2) and introduced into the fermentation reactors (3). The correction agent tank for the pH assures, through the control system, the conditions for the process of anaerobic fermentation.

The resulted biogas is passed through a filter for retaining the  $H_2S$  (5) and after that, through a system used for retaining  $CO_2$  (6), after which takes place the  $CO_2$  desorption and the compression of the  $CO_2$  in the adjacent system and the purified biogas is sent for being used (8).

The used material is discharged through the means of a gravimetric system (9), and the solid material is retained. A part of the resulting liquid is neutralized when the case, in the system (10) and sent to the sewerage network, or is transported by the recirculation pump (2) from the suspension preparation tank (1). The fermentation reactors are thermostat heated with the system (11). For the homogenization of the suspension is used a bubbling system (12) made of polypropylene pipes to avoid the possible corrosion. Also, for depositing small quantities of biogas of the purpose of analyzing, the installation is equipped with a small tank (13) positioned at the top of the reservoirs for being dried using the natural drying, and after that is sent to a compost deposit for being used as a soil fertilizer.

The research materials came from the local sources located near Timisoara city. The types of agricultural biomass considered are degraded corn cob and wheat grains mixed with wastewater from treatment plants. The fermentation process was monitored for 41 days, recording the following parameters for the two reactors: pressure, pH, temperature and biogas production.

## RESULTS AND DISCUSSION

Statistical analysis for biogas production was performed with Statgraphics software, a statistics package that performs and explains basic and advanced statistical functions. The outputs from the statistical analysis are presented in the next figures.

The main procedure for comparing data from two samples is the Two-Sample Comparison procedure. This procedure calculates various statistics and graphs for each sample, and it will run several tests to determine whether there are statistically significant differences between the two samples. Figure 2 presents the comparison for two samples of data.

The histogram for the R2 reactor is displayed above the horizontal line. The histogram for the R1 reactor is inverted and displayed below the line. The shapes of the distributions are similar, with a possible shift of the R2 distribution to the right of the R1.

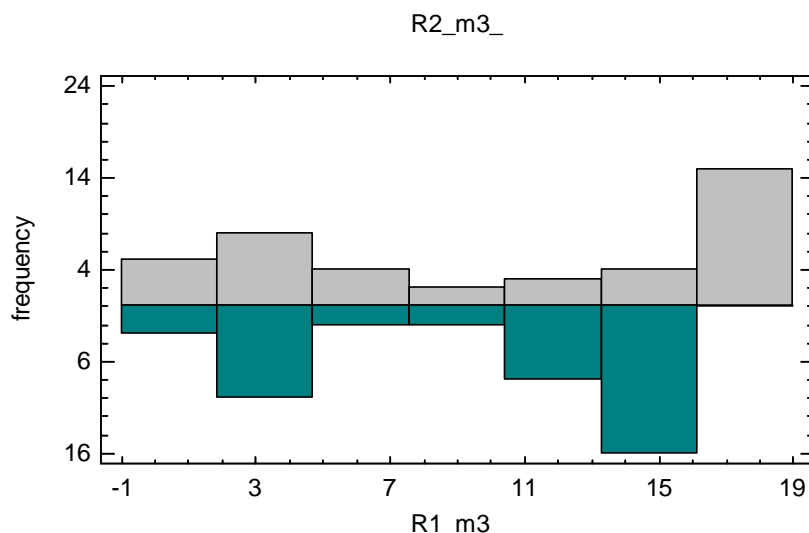

Figure 2. Two-Sample Comparison for produced biogas from R1 and R2 fermentation reactors [m<sup>3</sup>]

The *Summary Statistics* calculated for each sample is shown in Table 1. There are n1 = 41 observations for R2, ranging from 0.234 to 17.449 m<sup>3</sup>, and n2 = 41 observations for R1, ranging from 0.977 to 14.612 m<sup>3</sup>.

Table 1: Summary Statistics for amount of biogas production

	R2 [m <sup>3</sup> ]	R1 [m <sup>3</sup> ]
Count	41	41
Average	10.1676	9.49954
Standard deviation	6.62647	5.03266
Coefficient of variation	65.1722%	52.9779%
Minimum	0.234	0.977
Maximum	17.449	14.612
Range	17.215	13.635
Std. skewness	-0.6274	-1.42142
Std. kurtosis	-2.23918	-2.04412

Of particular interest here are the standardized skewness and standardized kurtosis, which can be used to determine whether the samples come from normal distributions. Values of these statistics outside the range of -2 to +2 indicate significant departures from normality, which would tend to invalidate the tests which compare the standard deviations. In this case, both standardized skewness values are within the range expected. Both samples have standardized kurtosis values outside the normal range.

The histogram for the pressure inside R1 reactor is displayed above the horizontal line (P1) respectively, the histogram for the R2 reactor is inverted and displayed below the line (P2). This is shown in Figure 3.

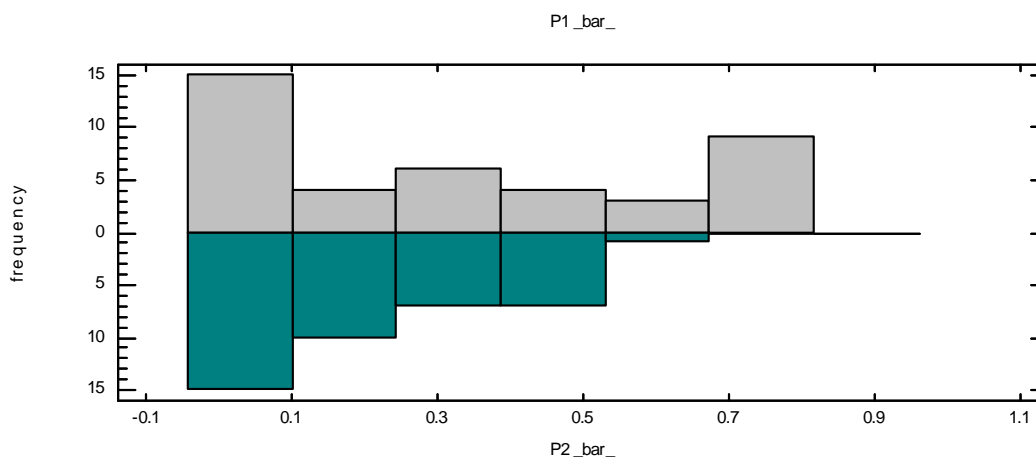

Figure 3. Two-Sample Comparison for pressure inside R1 and R2 fermentation reactors [bar]

The *Summary Statistics* calculated for pressure inside biogas reactors is shown in Table 2. There are 41 observations for P1, ranging from 0.01 to 0.79 bar, and 40 observations for P2, ranging from 0.0 to 0.6 bar.

Table 2: *Summary Statistics for pressure inside biogas reactors*

	P1 [bar]	P2 [bar]
Count	41	40
Average	0.319756	0.18925
Standard deviation	0.281225	0.158671
Coefficient of variation	87.9498%	83.8418%
Minimum	0.01	0.0
Maximum	0.79	0.6
Range	0.78	0.6
Std. skewness	0.997429	1.25697
Std. kurtosis	-1.87883	-0.836144

In this case, both standardized skewness values are within the range expected. Both standardized kurtosis values are within the range expected.

Of particular interest is the confidence interval for the difference between the means, which extends from 0.0291754 to 0.231837. Since the interval does not contain the value 0, there is a statistically significant difference between the means of the two samples at the 95.0% confidence level.

In this case, the t-test has been constructed to determine whether the difference between the two means equals 0.0 versus the alternative hypothesis that the difference does not equal 0.0. Since the computed P-value is less than 0.05, we can reject the null hypothesis in favor of the alternative

The histogram for the pH in R1 reactor is displayed above the horizontal line (pH1) respectively, the histogram for the R2 reactor is inverted and displayed below the line (pH2). This is shown in Figure 4.

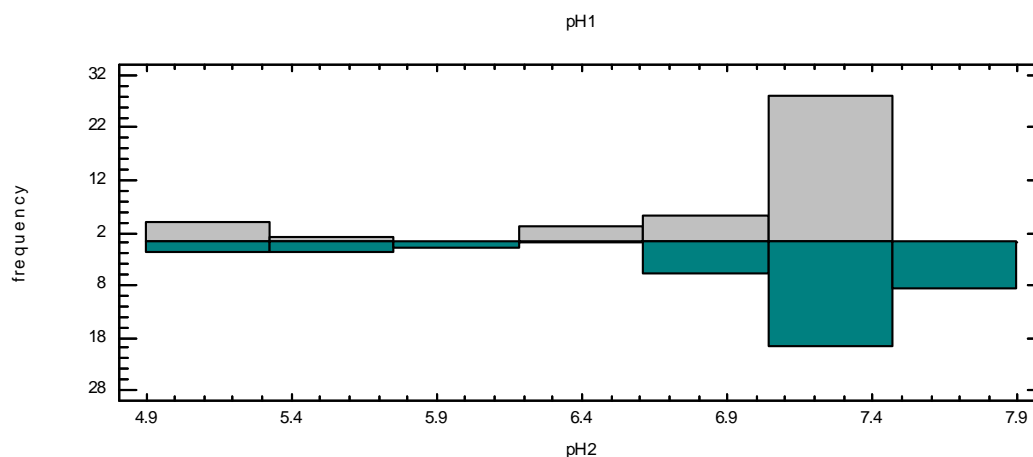

Figure 4. Two-Sample Comparison for pH inside R1 and R2 fermentation reactors

The *Summary Statistics* calculated for pH inside biogas reactors is shown in Table 3. There are 41 observations for pH1, ranging from 5.1 to 7.4, and 40 observations for pH2, ranging from 5.2 to 7.5.

Table 3: Summary Statistics for pressure inside biogas reactors

	pH1	pH2
Count	41	40
Average	6.87561	7.0525
Standard deviation	0.683659	0.627567
Coefficient of variation	9.94326%	8.8985%
Minimum	5.1	5.2
Maximum	7.4	7.5
Range	2.3	2.3
Std. skewness	-4.78941	-5.29462
Std. kurtosis	2.93877	4.20662

In this case, both samples have standardized skewness values outside the normal range. Both samples have standardized kurtosis values outside the normal range. The 95% confidence interval for the difference between the means extends from -0.467327 to 0.113547.

The average CH<sub>4</sub> concentration is 68.5 % for R1 reactor respectively, 72.0 % for R2 fermentation reactor. Also, the average CO<sub>2</sub> is 31.0 % for R1 and 28.0 % in case of R2 reactor.

## CONCLUSIONS

The wide variety of biomass sources implies a large range of biomass fuel properties, with direct influence on quality and quantity of biogas produced through anaerobic fermentation. Waste biomass could provide a significant part of the energy demand if appropriate conversion technologies are used.

Several facts are of particular interest:

1. The average biogas quantity of R2 is about 0.668 m<sup>3</sup> higher than that of the R1.
2. The standard deviation of the R1 is less than that of the R2, indicating that the biogas quantity of R1 may be less variable than those of the R2.
3. The average pressure inside biogas reactors R1 is about 0.13 bar higher than that of the R2.
4. The average pH inside biogas reactors R2 is about 0.17 higher than that of the R1.



## ACKNOWLEDGEMENT

This work was partially supported by a grant of the Romanian National Authority for Scientific Research and Innovation, CNCS – UEFISCDI, project number PN-II-RU-TE-2014-4-1043.

## REFERENCES

- Cioabla AE. (2009). Theoretical and experimental contributions concerning biogas production from biomass residues. *PhD Thesis*. Timisoara: Politehnica Publishing House.
- Cioabla AE., Pop N., Trif-Tordai G., Calinoiu DG. (2016). Comparative analysis of agricultural materials influenced by anaerobic fermentation for biogas production in terms of ash melting behavior. *Journal of Thermal Analysis and Calorimetry*, doi: 10.1007/s10973-016-5637-x
- Elango D., Pulikesi M., Baskaralingam P., Ramamurthi V., Sivanesan S. (2007). Production of biogas from municipal solid waste with domestic sewage. *Journal of Hazardous Materials*, doi: 10.1016/j.jhazmat.2006.07.003.
- Savprod SA., Politehnica University of Timisoara. (2007). Process and installation for obtaining biogas from biomass. *Romanian patent* no. 122047/26.07.2007.
- Statgraphics - The User's Guide to STATGRAPHICS® Centurion XV, 2005.

V International Conference  
„ECOLOGY OF URBAN AREAS“ 2016

**GLOBAL ISSUES AND URBANIZATION: RELATION BETWEEN  
GLOBAL SOCIETAL CHALLENGES AND SOIL SECURITY FOR  
SUSTAINABLE DEVELOPMENT**

**Hosam BAYOUMI HAMUDA**

Óbuda University, Rejtő Sándor Faculty of Light industry and Environmental Protection Engineering,  
Institute of Environmental Protection Engineering, Budapest, Hungary  
bayoumi.hosam@rkk.uni-obuda.hu

**ABSTRACT**

*If managed well, urbanisation can bring important benefits for development. The Linkages between science and policy on issues of sustainable development have become increasingly sophisticated. The world is facing a serious environmental, social and economic challenge: climate change, environmental pollution, public health as well as the world population increases, pressure on soil also increases and the natural capital of soil faces continuing reduces. Soil is the basis of the landscape and ecosystem that provides biophysical, economic, cultural and spiritual services to the humanity and to all global biotic factors. Food and water securities, climate change limit, ecosystem development, biodiversity protection, energy sustainability, etc. are the main basic elements of global societal challenges and the concept of soil security can be used to provide a useful links between soil and important basic elements in sustainable development. A fully functioning soil lies at the centre of solving the issues of food and water securities, biodiversity, climate change and fresh-water regulation and other global environmental problems. So, functioning soil is need for improvement of the ecological and human sustainable developmental ecosystems. The most significant threats to soil function at the global scale are soil erosion, loss of soil organic carbon and nutrient imbalance. Increasing human demands on soil-derived ecosystem services requires reliable data on global soil resources for sustainable development. Finally, it is true that the world that secures its soil will sustain itself.*

**Key words:** *Urbanization, Global issues, Global societal challenges, Soil security, Sustainable development.*

**GLOBAL URBANIZATION**

Urbanization provides new jobs and new opportunities for millions of people in the world, and has contributed to poverty eradication efforts worldwide. At the same time, rapid urbanization adds pressure to the resource base, and increases demand for energy, water, and sanitation, as well as for public services, education and health care. People migrate to urban centres hoping to secure a better future for themselves and their families. It is obvious that the issue of urbanization is multidimensional complexity. Urbanization can basically be caused by 3 factors: 1) natural population increase, 2) rural–urban migration, and 3) annexation (Jacquemin, 1999; Brockerhoff, 2000; Taubenböck et al, 2009a). However, large urban areas have become focal areas in our world, selling dreams and become at the same time a conglomeration of individual dreams. More people are pushing faster into cities. The phenomenon of increasing the proportions of the population living in urban areas is called urbanization (UN, 2008). Birch and Wachter (2011) mentioned that in 2010, a majority of the world’s population lived in cities, an important milestone actually reached in 2008; and by 2050, this proportion will approach 70%. These simple facts point in 2 directions: 1) looking back, they confirm the intensity with which the world has urbanized over the past 50 years and, 2) moving forward, they mark the world’s cities as the central terrain on which the critical issues of human development will play out over the course of the 21<sup>st</sup> century. Cohen (2011) said that the decade ending in 2010 spanned three unique, important transitions in the history of human-kind. Before 2000, young people always outnumbered old people. From 2000 forward, old people will outnumber young people. Until approximately 2007, rural people always outnumbered urban people. From approximately 2007

forward, urban people will outnumber rural people. From 2003 on, the worldwide median number of children/woman/life-time at current fertility rates was at or below the number required to replace the parents in the following generation, even though the declining average total fertility rate remained above the replacement level. Malpezzi (2011) stated that the world's population, roughly 6.7 billion people, spreads over about 13 billion hectares of land. Much of this land is arid or otherwise inhospitable to settlement, but more on that later. Variously considered, people live in nations, regions, cities, and neighbourhoods. The study of their urbanization is, more or less, the study of density as it occurs in these venues. Yeh (2011) mentioned that China has experienced rapid urban growth since the adoption of Economic Reform and Open Policy in 1978. Not only is more than 1/3 of the country's population now living in cities, but the remaining population is becoming increasingly dependent on cities and towns for its economic survival and livelihood. Already, more than half of the world's population live in towns and cities, and most future population growth will occur in the urban areas of developing countries (Figure 1).

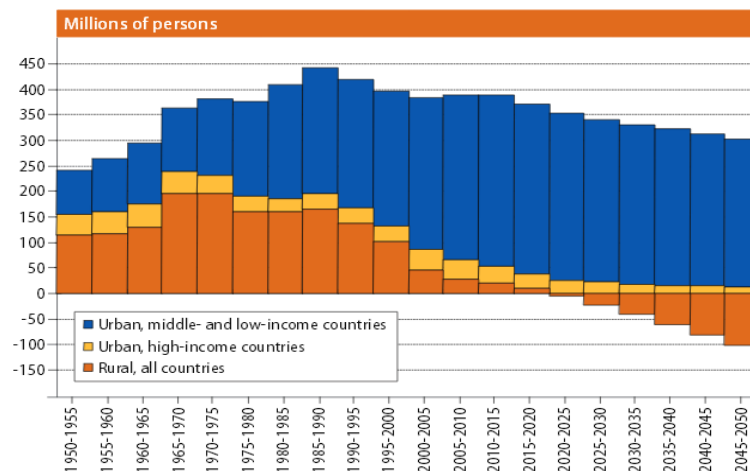

Figure 1. Urban and rural population growth, high-, low- and middle-income countries, 1950 to 2050 (Source: United Nations, Department of Economic and Social Affairs, Population Division, 2011)

Montgomery and Balk (2011) concluded that as urban populations continue to grow, poor countries and international aid agencies are likely to face mounting pressure to rethink their development strategies and set priorities with both rural and urban interests in mind. To plan for future growth, they will require informative forecasts of city size that are free from systematic bias. Unfortunately, demographic researchers are not yet in a position to deliver these scientific inputs. Sheppard (2011) mentioned that from the perspective of global urbanization, the first decade of the 21<sup>st</sup> century will be seen not as the time when the problems associated with urbanization first became apparent, nor as the time when the basic outlines of policy solutions first attained widespread recognition, if not agreement. The importance of infrastructure provision, the need for legal institutions that recognize and seek to internalize the externalities (positive and negative) intrinsic to high-density settlements, and the connection of housing provision to human health and social order have all been understood. Landis (2011) said that once known as urban activity models, urban growth models emerged in the mid-1960s out of advances in regional science, huge improvements in computing speed and storage capacity, a newfound surplus of detailed activity data, and federal mandates coupled with funding for metropolitan planning organizations to back up transportation funding requests with careful projections and hard-headed analysis. Overhyped and underdeveloped, early urban models soon proved unreliable. Seto (2011) concluded that the size of the world's growing urban population gives urgency to the need for accurate estimates of the location, size, and growth of existing urban areas as well as forecasts of likely regions, magnitudes, and configurations of future urban growth. However, to date, there exists no global database that accurately describes and maps which portions of Earth's habitable land are urbanized, or how those portions have changed over the recent decades. Satellite remote sensing and spatial modelling offer tremendous opportunities to map historical patterns of urban growth, monitor urban areas, and forecast urban expansion. Ottichilo (2011) recognized the fast-growing Nairobi (Kenya), the most populous city in East Africa, offers an important example of how a

municipality that lacks modern maps and databases turns to spatial technologies, especially remote-sensing and geographic information system technologies, to track urban growth and development and inform public and private infrastructure investments and other decision-making. The recent adoption of these tools has assisted in the management of a city that in less than 100 years has burgeoned from a British colonial capital with a population of 10500 to a modernizing metropolis with over 3 million inhabitants. Vinod (2011) found that in India, with an urban population of about 341 million (2007 estimate), is challenged with how to provide adequate levels of infrastructure and services in its many rapidly growing cities. Although only 29.2% of the total population is urban, in absolute terms that population is huge, almost equal to the combined urban population of the US, France, and Italy. Moreover, its urban population is growing at a high rate, projected at about 2.46% per year for the next 25 years. Currently, India represents 12% of total global urban population growth.

Urban population growth is expected to continue setting the pace of world population growth, and in the next 10-15 years, for the first time in history, the world rural population is expected to decline (Figure 2).

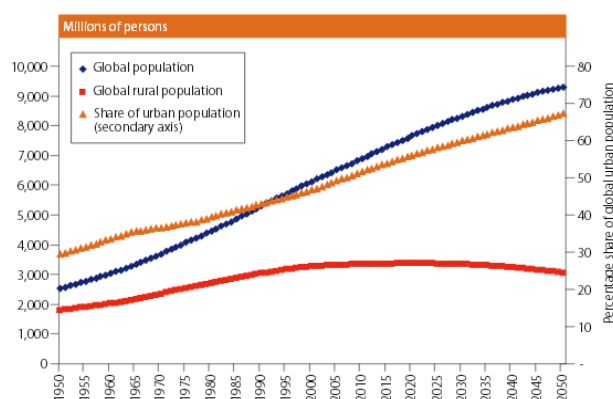

Figure 2. Population trends and projections, 1950-2050 (Sources: United Nations, Department of Economic and Social Affairs, Population Division (2011)).

Today cities are the home of more than 50% of the earth's population (UN, 2008). In Europe even 75% of the population live in urban areas, which cover only 4% of the area (Georgi, 2010). Consequently, urbanization is not local, regional or national, it is global phenomenon. The worldwide phenomenon of urbanization is exceptionally dynamic in upcoming developing countries, where unprecedented urban growth rates have occurred over the last 30 years (Taubenböck et al, 2009b). It is along with climate change arguably the most dramatic form of irreversible land transformation. The dynamics of urban development in recent history are nothing else than awesome.

A basic framework proposes systematization for a chronologic workflow to approach the global problem of urbanization from the problem statement to the benchmarking of success or failure (Figure 3).

There is considerable regional diversity in the patterns of urbanization and an even greater variation in the level and pace of urbanization of individual countries. For example, on average more than three quarters of the Latin America and the Caribbean region is highly urbanized, whereas least developed countries and landlocked developing countries are still predominantly agricultural - although their path towards urbanization is expected to accelerate in the next decades (Table 1).

The late urbanization in Asia and Africa is expected to gain speed and concentrate the majority of the additional 3 billion urbanites during 2010-2050. Similarly, the number of urban agglomerations (750,000 inhabitants or more) and the number of inhabitants per agglomeration are expected to grow significantly in Asia and Africa by 2025 (United Nations, Department of Economic and Social Affairs, Population Division, 2011). It is expected that over 80% of the urban population added in the next 15

years will be found in middle-income countries such as China, India, South Africa, Nigeria, Indonesia and Pakistan.

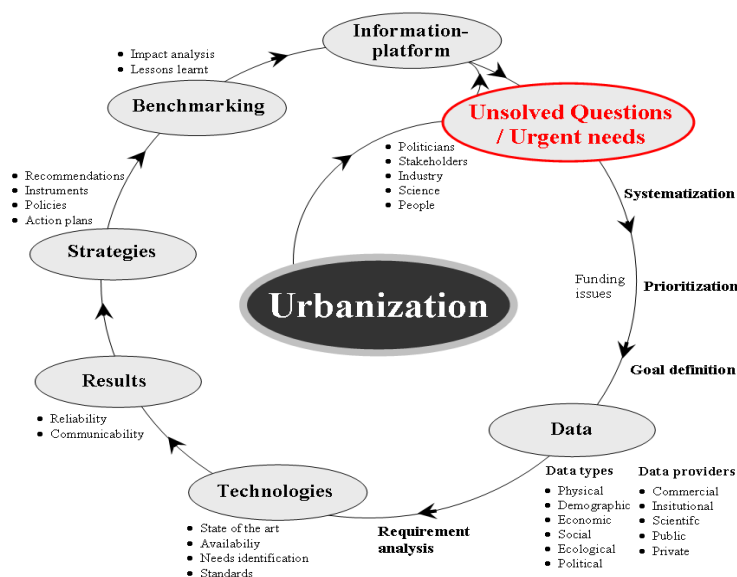

Figure 3. A framework for holistic strategy development to address the global challenge of mega-urbanization (Source: Taubenböck, 2011)

Table 1. Expected regional figures for share of urban population (Source: United Nations, Department of Economic and Social Affairs, Population Division (2012))

Country/region	Percentage in year				
	1975	2000	2012	2025	2050
World	37.7	46.7	52.6	58.0	67.2
More developed regions	68.7	74.1	78.0	81.1	85.9
Less developed regions	27.0	40.1	47.1	53.6	64.1
Africa	25.6	35.6	39.9	45.3	57.7
Asia	25.0	37.4	45.7	53.1	64.4
Europe	65.2	70.8	73.1	76.1	82.2
Latin America and the Caribbean	60.7	75.5	79.4	82.5	86.6
North America	73.8	79.1	82.5	85.0	88.6
Australia and New Zealand	85.4	86.9	88.9	90.3	92.4
Oceania	71.9	70.4	70.7	71.1	73.0
Least developed countries	14.7	24.3	28.9	35.2	49.8
Small island developing States	45.8	55.5	59.5	62.4	67.3
Landlocked developing States	22.2	26.1	28.3	32.6	45.6

The Global Risks 2015 Report looks at four areas that face particularly daunting challenges in the face of rapid and unplanned urbanization: infrastructure, health, climate change, and social instability. While the challenges posed by large-scale urbanization are immense, the future of human development requires that we find ways to promote socially inclusive growth, environmental sustainability, and resilient infrastructure. The timely and relevant scholarship assembled in *Global Urbanization* will be of great interest to scholars and policymakers in demography, geography, urban studies, and international development. Urban people change their environment through their consumption of food, energy, water, and land. And in turn, the polluted urban environment affects the health and quality of life of the urban population.

### **The sustainable eco-city**

The eco-city aims to curb all the negative factors that urbanisation has had on the natural environment. This includes reducing air pollution, water pollution, waste dumping and increasing use of space and energy resources. An eco-city aims to do many things such as:

- absorb rainfall to prevent flooding and pollution of fresh water supplies
- maintain arable land in surrounding areas to provide food
- increase public transport and fuel efficient vehicles; and
- improve energy use, technology and recycling.

### **Smart growth cities**

The smart growth city requires increasing the number of people within smaller areas of city living. Smart city planning requires a condensation of people, buildings and goods and services as well as eliminating individual cars. Smart city planning allows for people to live, work and play all within walking distance. The concept of eliminating all cars in urban areas and reducing public transport within the city centres is believed to help reduce pollution, a major issue of urbanization. Smart growth cities promote walking or cycling as primary means of transport within the city centre.

## **URBANIZATION, FOOD SECURITY AND SUSTAINABLE DEVELOPMENT**

To minimise the negative effect, Hu and Chen suggested to better deal with the relationships between market and government, between dispersion and concentration and between economic development and social development in the process of urbanisation (Hu and Chen, 2015). Estimates indicate that food production will have to increase 70% globally to feed an additional 2.3 billion people by 2050. Food demand is anticipated to continue to shift towards more resource-intensive agricultural products, such as livestock and dairy products, thereby exerting additional pressure on land, water and biodiversity resources.

Current agricultural practices are a leading source of greenhouse gas emissions, while also leading to other problems, such as loss of soil fertility and water pollution from run-off. Increased temperatures and more volatile weather patterns caused by climate change may already be affecting crop yields, affecting incomes and agricultural production. Currently, it is estimated that 32% of the total food produced globally is wasted. In order to substantially reduce the quantity of food lost and wasted, changes have to take place at different levels of the food chain: production, storage, transportation and consumption. In developed countries, efforts are most needed at the retail and consumer end, owing in part to management practices and consumption habits. In developing countries, interventions are needed at the producer end, before food reaches the market, to address inadequate harvesting techniques and storage conditions.

Nutrition outcomes are largely determined not only by food production and accessibility but also by food quality and diversity. A considerable potential for increasing the nutritional status of people and the efficiency of the whole food chain lies in encouraging changes in diet and consumption patterns, as well as designing pro-nutrition policies in other sectors, such as health and education.

An increase in food production will also require integrating sustainable practices, particularly regarding the use of natural resources. Many of the current agricultural practices have relied on cheap energy and abundant water and land, and are a leading source of greenhouse gas emissions. These practices are now proving unsustainable for the environment and health, due to contamination of air, land and water sources. At the same time, they have led to substantial productivity losses, thereby posing risks to food security. Thus, increasing food production and improving distribution to respond to population growth, urbanization and a change in consumption patterns will require an integrated approach to addressing several challenges simultaneously along the entire food chain. Such an integrated approach to food security and environmental sustainability should also take into

consideration the nexus of food, water, energy, environment and climate, while reorienting food production, distribution and consumption.

- The first challenge is to increase food production, while minimizing the environmental impact and increasing natural resource efficiency. This will require increasing agricultural productivity, in particular in developing countries where the agricultural sector contributes an important share of gross domestic product and where large productivity gaps still exist.
- The second major challenge will be to improve the access to food and markets, as hunger often occurs in countries where there is enough food produced. Income poverty is a major factor preventing access to food.
- The third challenge is to orient food consumption towards “sustainable diets”, that is, diets that are less resource-intensive and more nutritious, which will be crucial for the sustainability of the food system.
- Finally, in an increasingly interconnected world, improving agricultural productivity and the allocation of food within and across countries requires well-coordinated actions at local, national and global levels.

An increase in food production will also require integrating sustainable practices, in particular in the use of natural resources. Many of the current agricultural practices have relied on cheap energy and abundant water and land, and are a leading source of green-house gas emissions. These practices are now proving unsustainable for the environment and health. At the same time, they have led to substantial productivity losses, thereby posing risks to food security. Thus, agricultural productivity and an efficient use of natural resources, as well as climate-related adaptation and resilience-building, should be part of an integrated policy approach.

Even if 90% of the growth in crops will come from higher yields, land availability will continue to be crucial for agriculture. Arable land would need to expand by 12% in developing countries by 2050 (FAO, UN, 2009a)

Every year, about 12 million hectares of agricultural land are lost owing to land degradation, adding to the billions of hectares that are already degraded (Beddington et al., 2012). Soil degradation not only affects its fertility, reducing agricultural production opportunities, but also has negative effects on the hydrologic cycle, and climate, biodiversity, landscape and other ecosystem services. There are many factors leading to soil degradation which should be prevented. The excessive use of chemical fertilizers and pesticides is considered the major factor affecting the resilience of land. For instance, in the past 50 years, global fertilizer use increased by 500%, causing widespread pollution (Earth Security Initiative, 2012). Managing the use of fertilizers will be crucial for long-term land development; for example, in the United States, it has been demonstrated that in the long term, organic agricultural methods can outperform conventional chemical farming in terms of crop yield, sustainability and profit.

The urbanization process is also increasing competition for arable land and wetlands. So far, urban areas occupy about 1% of the total land surface (UN Environment Programme, 2012a), but urbanization is projected to continue at a fast pace in the next decades (see chap. III). Between 2012 and 2050, the world urban population is expected to increase by 69%. At the same time, renewable energy strategies, such as use of biofuels, are increasing demand for land resources. Hence, developing the potential to create more sustainable land management systems, in order to reverse current trends in food insecurity and unsustainable land degradation, is desirable and possible (UN Environment Programme, 2012a).

FAO has estimated that meat consumption in 2050 will amount approximately to 4.65 billion tons. Poultry meat consumption level is expected to be 2.3 times higher than in 2010, while consumption of other livestock products is expected to be between 1.4 and 1.8 times higher (FAO, UN, 2009c). The world’s average daily calorie availability is projected to raise from an average of 2,789 kilocalories per person in 2000 to 3,130 kilocalories per person in 2050, a 12% increase. Further, current food waste is around 30-50% of total production (FAO, UN, 2011d; Institution of Mechanical Engineers, 2013).

Water is another essential natural resource for agriculture, whose limit of sustainability may have already been reached in many regions. Global water withdrawals have tripled over the last 50 years and water withdrawals for irrigation are expected to increase by almost 11% by 2050 (FAO, UN, 2009c). Yet, today, 80% of the world's population lives in areas with high levels of threat to water security, particularly in developing countries (UN Environment Programme, 2012b). In addition, it is expected that the increasing and competing demands for water will aggravate the serious depletion of surface-water resources. Water scarcity represents an important challenge for agriculture, which uses 70% of global freshwater (FAO, 2009b).

In the coming decades, it is expected that climate change will continue to have adverse effects on agricultural production. Even a modest climate change of about 2°C can change rainfall patterns, resulting in a shorter growing season and lower agricultural production, particularly in areas that are already hot and dry, for example, in Africa and South Asia (Beddington et al., 2012).

There are several factors contributing to the problem of climate change. Current agriculture practices, including land clearing for cultivation and inefficient use of fertilizers and organic residues, constitute one such factor, being responsible for 25-33% of greenhouse gas emissions (Beddington et al., 2012). While agriculture is a major contributor to global greenhouse gas emissions, it can also be part of the solution to the problem of climate change.

## **SUSTAINABLE DEVELOPMENT**

The world is faced with challenges in all three dimensions of sustainable development: economic, social and environmental. More than 1 billion people are still living in extreme poverty and income inequality within and among many countries have been rising; at the same time, unsustainable consumption and production patterns have resulted in huge economic and social costs and may endanger life on the planet. Achieving sustainable development will require global actions to deliver on the legitimate aspiration towards further economic and social progress, requiring growth and employment, and at the same time strengthening environmental protection.

Globalization is not a new phenomenon. In the nineteenth century, the world economy underwent its first process of globalization, driven by technological progress in the form of lower transportation and communication costs. World trade expanded at close to 4% annually on average throughout the century, much faster than in previous centuries (O'Rourke and Williamson, 2004). The global community has made great strides in addressing poverty, but a mere continuation of current development strategies will not suffice to achieve sustainable development. Economic and social progress remains uneven, the global financial crisis has revealed the fragility of progress, and accelerating environmental degradation inflicts increasing costs on societies. There are a number of economic, social, technological, demographic and environmental megatrends underlying these challenges to which a sustainable development agenda will have to respond. These trends influence and reinforce each other in myriad ways and pose enormous challenges.

Urbanization is proceeding rapidly in developing countries, globalization and financialization are perpetuating inequalities, while exposing countries to greater risks of contagion from crises, and food and nutrition as well as energy security is threatened by competing demands on land and water, as well as environmental degradation. Information and communications technologies have also made the diffusion of information easier, and have facilitated better access by developing countries to the global knowledge pool. Because of the critical role of science and technology in addressing the social, economic and environmental challenges faced by countries, this wider diffusion is contributing to the progress of development in a wide range of areas. At the same time, innovative activity and technology development continue to be concentrated in a small number of advanced economies. Only very few countries such as Brazil, China and India, have entered this segment in recent decades, because core research and development activities are very rarely outsourced and remain overwhelmingly centred at corporate headquarters in developed countries (Castaldi et al., 2009).



Sustainable development is a multi-dimensional way of thinking about the interdependencies among natural, social, and economic systems in our world. It represents a process in which economics, finance, trade, energy, agriculture, industry, and all other policies are implemented in a way to bring about development that is economically, socially, and environmentally sustainable. Thus, the goal of sustainable development is to meet the needs of the present without compromising the ability of future generations to meet their needs. Sustainable development calls for improving the quality of life for all of the world's people without increasing the use of our natural resources beyond the Earth's carrying capacity. While sustainable development may require different actions in every region of the world, the efforts to build a truly sustainable way of life require the integration of action in three key areas:

- Economic Growth and Equity
- Conserving Natural Resources and the Environment
- Social Development.

Sustainable development is the parallel consideration of healthy environments, life, and human well-being. This includes issues of population, climate, economic prosperity, energy, natural resource use, waste management, biodiversity, watershed protection, technology, agriculture, safe water supplies, international security, politics, green building, sustainable cities, smart development, community relations, human values, etc. All these "pieces" are parts of the sustainable society puzzle, because they are the basic ingredients of everyday life.

Overall, globalization has provided opportunities for emerging economies and developing countries, and in recent years their growth rates have been consistently higher than growth rates in the developed world. There are two critical caveats with respect to this broad trend of convergence, however. It has not made developing countries immune to cyclical stocks: indeed, globalization has increased countries' vulnerabilities; and it is far from uniform, with some developing countries not only excluded from this convergence process but falling further behind. Average per capita growth also hides increasing inequalities within countries, which are also partly related to globalization. A significant part of the global population therefore does not benefit from convergence (Dervi, 2012).

Sustainable development will need to be inclusive and take special care of the needs of the poorest and most vulnerable. Strategies need to be ambitious, action-oriented and collaborative, and to adapt to different levels of development. They will need to systemically change consumption and production patterns, and might entail, inter alia, significant price corrections; encourage the preservation of natural endowments; reduce inequality; and strengthen economic governance.

The world reached the poverty target 5 years ahead of the 2015 deadline. In developing regions, the proportion of people living on less than \$1.25 a day fell from 47% in 1990 to 22% in 2010. About 700 million fewer people lived in conditions of extreme poverty in 2010 compared with 1990. Still, results fall short of international expectations and of the global targets set to be reached by the 2015 deadline. It remains imperative that the international community takes bold and collaborative actions to accelerate progress in achieving the Millennium Development Goals (World Economic and Social Survey, 2013). Continuation of current development strategies will not suffice to achieve sustainable development beyond 2015. Moreover, relying on "business as usual" scenarios presents clear risks, because evidence is mounting that:

- (a) The impact of climate change threatens to escalate in the absence of adequate safeguards and there is a need to promote the integrated and sustainable management of natural resources and ecosystems and take mitigation and adaptation action in keeping with the principle of common but differentiated responsibilities;
- (b) Hunger and malnourishment, while decreasing in many developing countries, remain persistent in other countries, and food and nutrition security continues to be an elusive goal for too many;
- (c) Income inequality within and among many countries has been rising and has reached an extremely high level, invoking the spectre of heightened tension and social conflict;

- (d) Rapid urbanization, especially in developing countries, calls for major changes in the way in which urban development is designed and managed, as well as substantial increases of public and private investments in urban infrastructure and services;
- (e) Energy needs are likely to remain unmet for hundreds of millions of house-holds, unless significant progress in ensuring access to modern energy services is achieved;
- (f) Recurrence of financial crises needs to be prevented and the financial system has to be redirected towards promoting access to long-term financing for investments required to achieve sustainable development.

Three of cross-sectoral issues with immediate implications for realizing sustainable development, namely: (a) sustainable cities, (b) food and nutrition security and (c) energy transformation are under the focusing today.

An important sustainable development challenge arises from unsustainable consumption and production patterns that have evolved in developed countries, a pattern that is increasingly being followed by developing countries. For example, per capita green-house gas emissions levels in developed countries are 20-40 times greater than needed for stabilization of the atmospheric greenhouse gas concentration. The per capita ecological footprints in developed countries are 4-9 times greater than their bio-capacity. The high degree of inequality that accompanies and promotes these patterns makes them socially unsustainable and constrains achievement of the human development goals.

The outcome document of the UN Conference on Sustainable Development (UN, General Assembly resolution 66/288, annex.) provides guidance for achieving the transition to sustainable development as a means of increasing the well-being of current and future generations in all countries. Sustainable development strategies need to be inclusive and take special care of the needs of the poorest and most vulnerable. Strategies need to be ambitious, action-oriented and collaborative, taking into account different national circumstances. About 1 billion people still live in slums lacking access to basic infrastructure and services such as water, sanitation, electricity, health care and education. There might be 3 billion slum dwellers by 2050 unless decisive actions are taken.

Sustainable development of urban areas requires integration and coordination, including regarding land-use issues, food security, employment creation, transportation infrastructure development, biodiversity conservation, water conservation, renewable energy sourcing, waste and recycling management, and the provision of education, health care and housing. Investment in the reduction of waste production and improvement of waste collection and recycling systems is needed in most cities across the world. Providing access to modern energy services is a real challenge to urban authorities in developing countries which often do not have enough capacity to respond, nor the ability to raise the needed long-term financial resources for investment.

### **Financing sustainable development**

A significant share of the investments necessary to achieve sustainable development will have to come from private sources, which nonetheless will depend on the availability of public funds to match those investments, through the provision of guarantees and/or regulation to assure future revenue streams. Public financing, regulation and private market-based financing will therefore have to be combined, based on the specific characteristics of the newly created assets. Financing strategies for sustainable development in cities can draw upon a wide range of instruments. Sources of finance can have different degrees of stability and predictability. Innovative financing mechanisms can also make contributions to developing countries in respect of mobilization of additional resources for financing for development. Sustainable financing needs to be ensured across sectors, including agriculture, forestry, energy, health and education, as well as across economic segments, such as small and medium-sized enterprises, infrastructure and innovation, in both developed and developing countries. Special attention needs to be directed towards financing the global commons (e.g., the atmosphere, oceans, biodiversity and forests) and global health. A close partnership between local and national

authorities is needed to finance the sustainable development of cities. While cities need to raise financial resources from capital markets directly, financial oversight mechanisms must be in place to manage risks so that municipal borrowing does not result in an excess of non-performing loans in the banking system or the incurring of huge financial liabilities by the central government. Thus, for poor and rich cities alike, part of the financing would have to be directed towards addressing global environmental challenges and the livelihoods of present and future generations. Achieving the sustainability of cities can be conceived as entailing the integration of four pillars: social development, economic development, environmental management, and urban governance. Figure (4) presents the four pillars for achieving urban sustainability encompassing the balanced accomplishment of social and economic development, environmental management and effective governance.



Figure 4. Pillars for achieving sustainability of cities (Source: UN/DESA, Development Policy and Analysis Division, 2011)

The integration of the four pillars can generate synergies, for example, between waste and recycling management (environmental management) and access to water and sanitation (social development); between air quality conservation and green public transportation; and among production and distribution of renewable energy sources, green energy access, and adaptation to and mitigation of climate change, as well as between the goal of reducing inequities (urban governance) and that of ensuring adequate access to green housing, education and health (social development). Investment is the catalyst behind the realization of each of the component goals of urban sustainability.

## ENVIRONMENTAL DEGRADATION

The unusually stable global environment has been the precondition for unprecedented human development over the last ten thousand years; this stability is now under threat from human activity. Most critically, energy consumption has skyrocketed owing to rapid population and economic growth, resulting in unprecedented concentrations of CO<sub>2</sub> in the atmosphere and anthropogenic climate change. If greenhouse gas emissions, global resource consumption and habitat transformation continue at or above current rates, a state shift in the Earth's biosphere is likely (Barnosky and others, 2012), irreversibly changing the environmental conditions so favourable to human development in recent millennia. Damage to the global environment is reaching critical levels and threatens to lead to irreversible changes in global ecosystems. Most visibly in climate change, critical thresholds have already been exceeded.

Climate change poses numerous and stark challenges for sustainable development and its effects will be felt in all regions of the globe, although the intensity of exposure will vary. Degree of vulnerability will vary even more, with developing countries and the poor, which have contributed the least to global warming, likely to suffer the most. Climate change also puts pressure on natural resources that are essential for sustaining human civilization. In the past, resource scarcity was often presented as a critical challenge, but for much of the twentieth century, resource prices actually fell. The combination

of rapid economic expansion, continued population growth and a changing climate raises the spectre of resource scarcities. In the medium and long term, it may lead to a strong sustainability challenge. There is significant scope for substitution in many areas, yet certain forms of natural capital including the ecological services they provide cannot be replaced by man-made capital. Their exploitation has thus to be limited so as to preserve the overall capacity of ecosystems to provide those services (Ayres, 2007). Figure 5 presents a framework within which both human development and environmental protection can become universal goals and be integrated, ending the current separation between their domains of application. This framework can provide the basis for the post-2015 agenda. The ideas and the causal linkages presented in Figure (5) are abstract and very general. It is necessary to make them more concrete.

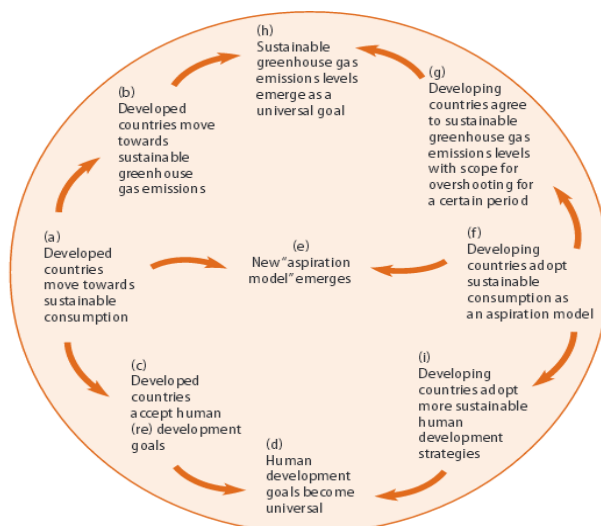

Figure 5. Framework for integrating human development and environmental protection goals and making them universal (Source: UN/DESA, Development Policy and Analysis Division, 2011).

Soil, water and energy in particular are critical resources for humanity, and their availability and use are tightly interconnected, with multiple feedback channels between them. All of them have strong links to agriculture and food production. Large unmet needs at the global level require and will inevitably lead to a further expansion in their use and exploitation. Combined with the additional impact of climate change, this expansion may very well lead to much tighter supplies, and thus to price volatilities and sustained price increases. Stresses in water supplies arise from the increase in consumptive use and pollution of freshwater, for which agriculture is overwhelmingly responsible. The consumption of agricultural products accounts for 92% of the global freshwater footprint, an indicator for humans' appropriation of freshwater resources (Hoekstra and Mekonnen, 2012).

### SOIL SECURITY "TO SAVE THE PLANET, WE MUST FIRST SAVE THE SOIL"

As noted earlier there are existing concepts which have been proposed that are similar to soil security, namely: Soil Quality, Soil Health and Soil Protection. Soil security, an overarching concept of soil motivated by sustainable development, is concerned with the maintenance and improvement of the global soil resource to produce food, fibre and freshwater, contribute to energy and climate sustainability, and to maintain the biodiversity and the overall protection of the ecosystem. Security is used here for soil in the same sense that it is used widely for food and water (McBratney et al., 2014). Soil degradation is a critical and growing global problem. As the world population increases, pressure on soil also increases and the natural capital of soil faces continuing decline. International policy makers have recognized this and a range of initiatives to address it have emerged over recent years. However, a gap remains between what the science tells us about soil and its role in underpinning ecological and human sustainable development, and existing policy instruments for sustainable development. Functioning soil is necessary for ecosystem service delivery, climate change abatement,

food and fibre production and fresh water storage. Yet key policy instruments and initiatives for sustainable development have under-recognized the role of soil in addressing major challenges including food and water security, biodiversity loss, climate change and energy sustainability. Soil science has not been sufficiently translated to policy for sustainable development. Two underlying reasons for this are explored and the new concept of soil security is proposed to bridge the science–policy divide. Soil security is explored as a conceptual framework that could be used as the basis for a soil policy framework with soil carbon as an exemplar indicator. There are 6 major challenges for society and soil security are present the Figure (6).



Figure 6. soil functions and the major challenges for society and soil security

### Sustainable Soil Management

Table (2) summarizes and describes the 4 main ways to manage the soil.

Table 2. The aims and strategies main 4 ways for soil management

Aim	Strategies
<b>1. Water efficiency and productivity</b>	
Increase plant water availability in rained agriculture	Minimise run-off; Maximise rainfall infiltration and storage in the soil
	Reduced non-productive evaporation
	Harvest and concentrate rainfall through run-off to crop area or for other use
Increase plant water availability in irrigated agriculture	Minimise water losses from irrigation system
	Efficient and effective and application of water
	Recharge aquifer/groundwater; water collection to enable off season irrigation
Increase plant water up-take	Increase productive transpiration
<b>2. Soil fertility</b>	
Improve nutrient availability and up-take	Reduce nutrient mining and loose
	Improve soil nutrient holding capacity and plant nutrient up-take capacity

<b>3. Plants and their management</b>	
Maximise yield	Use best suited planting material and optimise management
<b>4. Microclimate</b>	
Create favourable growing conditions	Reduce evapotranspiration
	Optimise temperature and radiation
	Reduce mechanical damage of plants

Soil delivers the ecosystem services on which human life depends. It provides functions imperative to society, such as food and fibre production, water filtration, and the recycling of carbon by the decomposition of plant and animal residues. These processes, with many being carried out by microorganisms in the soil, are also linked to some of the greatest challenges facing humanity. Consequently, the ability to deal with these challenges directly depends on our understanding of these microbes and how they interact with the minerals and plant roots in soil (the rhizosphere). A better understanding of this soil powerhouse could even enable us to engineer this layer to increase nutrient uptake by plants and reduce agricultural greenhouse gas emissions.

Every year, the world loses 75 billion tonnes of crop soil as a result of erosion due by wind, water and through agriculture. That's more than 205 million tonnes a day, and represents a cost of US\$ 70 per person per year. As it is estimated to take about 100 years to form 1 cm of topsoil, fertile soil is being lost much faster than it can be replaced through natural processes. It is therefore effectively a non-renewable and limited natural resource, and needs to be protected.

Because of this the security of soil in itself should be promoted to the status of a global existential challenge. Also, Soil Security can be defined as in McBratney et al. (2012) as being concerned with the maintenance and improvement of the world's soil resource to produce food, fibre and freshwater, contribute to energy and climate sustainability, and maintain the biodiversity and the overall protection of the ecosystem. In this definition, security is used in the same sense that it is used for food, water and energy. To frame this concept a set of dimensions need to be established and defined and, as with other concepts such as food and water security, these dimensions should account for the quantity, quality and accessibility of the soil.

The European Union Soil Protection Strategy is based on soil function and the threats to soil. As described earlier (Bouma and Droogers, 2007), there are seven functions defined. If we consider soil security, the function of the soil to (i) produce food and other biomass would be related to soil capability and soil condition, while soil capital would relate to (ii) storing, filtering and transformation and (iii) the provision for a habitat and gene pool. The cultural environment for mankind (iv) is related to soil connectivity and valued through the soil capital, where (vi) acting as a carbon pool is related to soil condition and capital, and being an archive for archaeological heritage (vii) is covered by soil condition and its connectivity. Although described as a function we would consider (v) source for raw materials, as a threat. The European Commission has identified five threats classified as erosion, compaction, contamination, organic matter decline, salinization, landslides, and surface sealing. Many of these would relate largely to soil condition, capability and capital. It is clear that the concepts of soil quality, health and protection are directly and implicitly related to the concept of soil security and its dimensions, but it would be suggested that the soil security concept is wider with clear dimensions to frame the value of soil and how people interact with it. Most importantly the soil security concept is strengthened by the proposal of the soil capability, capital, connectivity and codification dimensions, which are not explicitly identified in the other concepts being compared.

## CONCLUSIONS

- Soil has an integral part to play in the global environmental sustainability challenges of food security, water security, energy security, climate stability, biodiversity, and ecosystem services. Indeed, soil has the same existential status as these issues and should be highlighted and treated similarly.
- There is an imperative for a concept of soil that is similar to food, water and energy security. We have proffered the term soil security.
- The concept of soil security is multi-dimensional. It recognizes capability, condition, capital, connectivity and codification of soil entities and encompasses the social, economic and biophysical sciences.
- Soil security is a wider, more integrative, concept than ‘soil quality’, ‘soil health’ or ‘soil protection’.
- There is a persuasive need for developing a thorough risk-based framework for assessing soil security locally, regionally, nationally and globally using the dimensions of capability, condition, capital, connectivity and codification.

Finally, soil security should be risk based in the sense that it should recognize and utilize the uncertainties in the assessment of each of the dimensions and their combination.

## REFERENCES

- Ayres, R. (2007). On the practical limits to substitution. *Ecological Economics*, vol. 61 (1), 115-128.
- Barnosky, Anthony, and others (2012). Approaching a state shift in Earth’s biosphere. *Nature*, vol. 486 (7401), 52-58.
- Beddington, J., and others (2012). Achieving food security in the face of climate change. Final report from the Commission on Sustainable Agriculture and Climate Change. Copenhagen: CGIAR Research Program on Climate Change, Agriculture and Food Security.
- Birch, L. Eugenie, and Wachter, M. S. (2011). World Urbanization: The Critical Issue of the Twenty-First Century (Eds. Birch, L. Eugenie, and Wachter, M. S.). *Global Urbanization*. University of Pennsylvania, pp.: 3-23.
- Bouma, J., and Droogers, P. (2007). Translating soil science into environmental policy: a case study on implementing the EU soil protection strategy in the Netherlands. *Environ. Sci. Pol.*, 10, 454-463.
- Brockerhoff, M.P. (2000). An urbanizing world. *Population Bulletin*. 5, 3; Academic Research Library
- Castaldi, C., and others (2009). Technological learning, policy regimes, and growth: the long-term patterns and some specificities of a “Globalized” economy. In *Industrial Policy and Development: The Political Economy of Capabilities Accumulation*, Mario Cimoli, Giovanni Dosi and Joseph Stiglitz, eds. Oxford: Oxford University Press.
- Cohen, J. E. (2011). Human Population Grows Up. *Global Urbanization*. (Eds. Birch, L. Eugenie, and Wachter, M. S.). University of Pennsylvania, pp.: 24-31.
- Derviş, K. (2012). Convergence, interdependence, and divergence. *Finance and Development*, vol. 49 (3), 10-14.
- Earth Security Initiative (2012). *The Land Security Agenda: how investor risks in farmland create opportunities for sustainability*. London. March.
- Food and Agriculture Organization of the United Nations (2009a). *How to Feed the World in 2050: Proceedings of the Expert Meeting on How to Feed the World in 2050*. Rome. 24-26 June 2009, FAO Headquarters, Rome.
- Food and Agriculture Organization of the United Nations (2009b). *Investing in food security*. Rome. November.
- Food and Agriculture Organization of the United Nations (2009c). *Expert papers from the High-Level Expert Forum on How to Feed the World*, Rome, 12 and 13 October 2009. Available from <http://www.fao.org/wsfs/forum2050/wsfs-background-documents/wsfs-expert-papers/en/>.
- Food and Agriculture Organization of the United Nations (2011c). *The State of Food Insecurity in the World 2011: How Does International Price Volatility Affect Domestic Economies and Food Security*. Rome.
- Georgi, B. (2010). The challenges of sustainable urban development in Europe and its consequences for ruralurban relationships. PLUREL Conference, Copenhagen, Denmark.
- Hoekstra, A. and Mekonnen M. (2012). The water footprint of humanity. *Proceedings of the National Academy of Sciences*, vol. 109 (9), 3232-3237.
- Hu, B. and Chen, C. (2015). New urbanisation under globalisation and the social implications in China. *Asia & the Pacific Policy Studies*, vol. 2 (1), 34-43. doi: 10.1002/app5.68

- Jacquemin, A. R. A. (1999). *Urban Development and New Towns in the Third World. Lessons from the New Bombay experience*. Ashgate. Great Britain.
- Landis, John D. (2011). *Urban Growth Models: State of the Art and Prospects*. Global Urbanization. (Eds. Birch, L. Eugenie, and Wachter, M. S.). University of Pennsylvania, pp.: 126-50.
- McBratney, A., Fielda, J. D., and Koch A. (2014). The dimensions of soil security. *Geoderma* 213, 203-213.
- Malpezzi, S. (2011). *Urban Growth and Development at Six Scales: An Economist's View*. Global Urbanization. (Eds. Birch, L. Eugenie, and Wachter, M. S.). University of Pennsylvania, pp.: 48-66.
- Montgomery, M. R., and Balk D. (2011). *The Urban Transition in Developing Countries: Demography Meets Geography*. Global Urbanization. (Eds. Birch, L. Eugenie, and Wachter, M. S.). University of Pennsylvania, pp.: 89-106.
- O'Rourke, K., and Jeffrey Williamson (2004). Once more: when did globalisation begin? *European Review of Economic History*, vol. 8 (1), 109-117.
- Ottichilo, W. K. (2011). *Tracking Regional Growth and Development: The Nairobi Case*. Global Urbanization. (Eds. Birch, L. Eugenie, and Wachter, M. S.). University of Pennsylvania, pp.: 167-74.
- Sayed Sanjidaa (2014). *Urbanization, Food Security and Sustainable Development: A Challenge for Bangladesh*. Uppsala University, Department of Earth Sciences. Master Thesis, in Sustainable Development, Geotryckeriet, Uppsala University, Uppsala, pp.: 46.
- Seto, Karen C. (2011). *Monitoring Urban Growth and Its Environmental Impacts Using Remote Sensing: Examples from China and India*. Global Urbanization. (Eds. Birch, L. Eugenie, and Wachter, M. S.). University of Pennsylvania, pp.: 151-66.
- Sheppard, Stephen (2011). *Measuring and Modeling Global Urban Expansion*. Global Urbanization. (Eds. Birch, L. Eugenie, and Wachter, M. S.). University of Pennsylvania, pp.: 107-25.
- Taubenböck, H. (2011). The global issue "mega-urbanization": an unsolvable challenge for stakeholders, researchers and residents? *International Archives of the Photogrammetry, Remote Sensing and Spatial Information Sciences*, Vol. XXXVIII-4/C21. 28th Urban Data Management Symposium (UDMS 2011), September 28-30, 2011, Delft, *The Netherlands*, 143-148.
- Taubenböck, H., Wegmann, M., Roth, A., Mehl H., and Dech, S. (2009b). *Urbanization in India – Spatiotemporal analysis using remote sensing data*. *Computers, Environment and Urban Systems* 33. pp 179-188 DOI information: 10.1016/j.compenvurbsys.2008.09.003.
- Taubenböck, H. Wegmann, M., Roth, A., Schmidt, M. and Dech, S. (2009a). *Urbanization: A global change issue*. In: *Proceedings of the ISRSE conference*, Stresa, Italy. pp. 4.
- Tewari, V. (2011). *Managing Urban Infrastructure and Services in India*. Global Urbanization. (Eds. Birch, L. Eugenie, and Wachter, M. S.). University of Pennsylvania, pp.: 255-75.
- United Nations, Department of Economic and Social Affairs, Population Division (2008). *World Urbanization Prospects. The 2007 Revision - Highlights*. New York, 244 pp.
- United Nations, Department of Economic and Social Affairs, Population Division (2011). *World Population Prospects: The 2010 Revision*, vol. I, Comprehensive Tables, and vol. II, Demographic Profiles. ST/ESA/SER.A/313 and ST/ESA/SER.A/317.
- United Nations (2013). *World Economic and Social Survey 2013: Sustainable Development Challenges*. General Assembly resolution 55/2. ISBN 978 -92-1-10 9167-0
- Yeh, Anthony (2011). *Urban Growth and Spatial Development: The China Case*. Global Urbanization. (Eds. Birch, L. Eugenie, and Wachter, M. S.). University of Pennsylvania, pp.: 67-86.



V International Conference  
„ECOLOGY OF URBAN AREAS“ 2016

**COMPARATIVE RESULTS IN ANAEROBIC FERMENTATION OF  
SOME AGRO-INDUSTRIAL RECIPES INSIDE A PILOT  
INSTALLATION**

**Adrian Eugen Cioabla<sup>(1)</sup>, Dorin Lelea<sup>(1)</sup>, Francisc Popescu<sup>(1)\*</sup>, Gavrilă Trif-Tordai<sup>(1)</sup>,  
Alina Gabriela Dumitrel<sup>(2)</sup>**

<sup>(1)</sup> University Politehnica Timisoara, Faculty of Mechanical Engineering, Romania

<sup>(2)</sup> University Politehnica Timisoara, Faculty of Industrial Chemistry and Environmental Engineering, Romania  
adrian.cioabla@upt.ro, francisc.popescu@upt.ro, dorin.lelea@upt.ro, gavrila.trif-tordai@upt.ro,  
gabriela.dumitrel@upt.ro

**ABSTRACT**

*Due to the increasing energetic demand worldwide, the need for renewable energy becomes more and more stringent. In this context there exists an increased level of preoccupation relative to obtaining biofuels to be used complementary or even to replace the existing fossil fuels. Relative to this aspect, the use of biogas as a renewable fuel is one of the fields with increased interest in obtaining clean energy carriers to be further used in firing or cofiring processes. The present paper underlines the use of degraded cereal material together with residual waters inside a pilot installation existing inside the laboratories of Mechanical Engineering Faculty, Politehnica University Timisoara. Conclusions will be traced in regard to material general properties, the influence parameters during the process (temperature, pH) and biogas characteristics in terms of partial composition (methane, carbon dioxide) and obtained quantity for each batch of tested material.*

**Key words:** *Biogas, anaerobic fermentation, agro-industrial materials, pilot installation, biomass.*

**INTRODUCTION**

Biomass is a renewable fuel that is discharged simultaneously by burning heat and delivers an amount of CO<sub>2</sub> equal to that consumed in its genesis. It is expected that biomass will play a major role in replacing fossil fuels contributing to a great extent at the use of renewable resources by the year 2020 (Demirel & Scherer, 2008).

Agricultural biomass production is generally considered to have the greatest energy potential of the three main biomass sources (agriculture, forests and waste). With current technologies, biomass from agriculture can satisfy a wider range of demands (Petersen, 2008).

As considered, bioenergy from renewable resources is already today a viable alternative to fossil fuels; however, to meet the increasing need for bioenergy several raw materials have to be considered. Lignocellulose is the most abundant organic material on earth and is therefore a promising raw material for bioenergy production. Lignocellulosic materials contain cellulose and hemicellulose that are bound together by lignin (Petersen et al., 2007). One of the technologies used for energy recovery from biomass residues is the production of biogas through anaerobic fermentation.

Biogas is the combustible gas produced by the anaerobic digestion of organic material, e.g. animal manure, human excreta, kitchen remains, straws and leaves through the action of micro-organisms. Biogas is primarily composed of methane (CH<sub>4</sub>) and carbon dioxide (CO<sub>2</sub>), with smaller amounts of carbon monoxide (CO), hydrogen sulphide (H<sub>2</sub>S), ammonia (NH<sub>3</sub>), nitrogen (N<sub>2</sub>) and oxygen (O<sub>2</sub>) (Mateescu, 2008).

Biogas could become one of the most important alternative fuels and can potentially replace natural gas and oil as it can contribute to maintain mobility, while other alternative sources of electrical energy and heat generation are available (wind, solar energy, etc.). No negative or limited environmental side effects are observed because biogas can be produced from all types of “green” biomass (Busch et al., 2009).

Relative to the developing interest in the field of renewable energy sources, the present paper will underline an experimental study for obtaining biogas through anaerobic fermentation process inside a pilot installation by using a combination of residual water from a treatment plant located in Timisoara and degraded cereal material (corn and wheat). In the next paragraph there will be described all the necessary details to the experimental part.

## EXPERIMENTAL PART AND DISCUSSION

As previously stated, the used materials inside the experiment were degraded corn (grains), degraded wheat and used water from treatment plant. Tables 1 to 3 present the general properties of the used materials.

*Table 1: General characteristics for the used materials – part 1*

No.	MATERIAL	Moisture content (db) [%]	Ash content (db) [%]	Gross calorific value (db) [J/g]	Net calorific value (db) [J/g]
1.	Degraded corn	10	1.55	18400	16800
2.	Degraded wheat	9.65	5.55	19000	17500
3.	Waste water treatment plant	5.8	36	15000	14100

From table one it can be observed that the waste water has a very high ash content making it not suitable for further use in firing processes. The calorific value for the biomass substrates is high, indicating an increased energetic potential.

*Table 2: General characteristics for the used materials – part 2*

No.	MATERIAL	Carbon content [%]	Hydrogen content [%]	Nitrogen content [%]	Volatile matter content (db) [%]
1.	Degraded corn	40.3	6.6	1.3	85.7
2.	Degraded wheat	41.1	6.1	2.1	78.5
3.	Waste water treatment plant	32.1	5.1	5.1	37.7

From table 2 it can be observed that the C/N ratio is little over 30 for degraded corn and just under 20 for degraded wheat. According to literature, the optimum ratio is between 20 and 30 for mesophilic anaerobic fermentation and the two used substrates are very close to the indicated domain. This aspect makes them good candidates for laboratory testing.

*Table 3: General characteristics for the used materials – part 3*

No.	MATERIAL	Sulphur Content (db) [%]	Chlorine Content (db) [%]
1.	Degraded corn	0,103	0,034
2.	Degraded wheat	0,149	0,042
5.	Waste water treatment plant	0,51	0,11

From table 3 it can be observed that the chlorine and sulphur values are not very high, thus the materials are available to be used in firing process as an alternative. The test rig is presented below. The pilot installation was built in this purpose, namely to obtain biogas using different types of biomass in liquid formulas. The general schematics of the pilot installation are presented below.

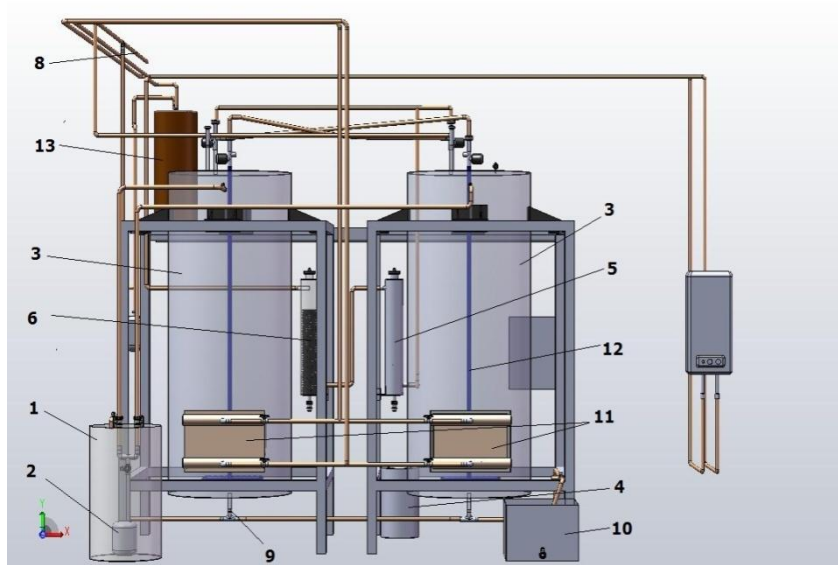

Figure 1. Principle scheme for the pilot installation used for obtaining biogas from biomass.

From the biomass deposit, the used material is passed through a mill, and then it's sent to the tank where the preparation of the suspension of biomass is made (1). The biomass suspension is transported with the help of the pump (2) and introduced into the fermentation reactors (3). The correction agent tank for the pH assures, through the control system, the conditions for the process of anaerobic fermentation. The resulted biogas is passed through a filter for retaining the H<sub>2</sub>S (5) and after that, through a system used for retaining CO<sub>2</sub> (6), after which takes place the CO<sub>2</sub> desorption and the compression of the CO<sub>2</sub> in the adjacent system (7) and the purified biogas is sent for being used (8).

The used material is discharged through the means of a gravimetric system (9), and the solid material is retained for being dried using the natural drying, and after that is sent to a compost deposit for being used as a soil fertilizer. A part of the resulting liquid is neutralized when the case, in the system (10) and sent to the sewerage network, or is transported by the recirculation pump (2) from the suspension preparation tank (1). The fermentation reactors are thermostat heated with the system (11). For the homogenization of the suspension is used a bubbling system (12) made by polypropylene pipes to avoid the possible corrosion. Also, for depositing small quantities of biogas of the purpose of analyzing, the installation is equipped with a small tank (13) positioned at the top of the reservoirs.

The determinations were made over a period of approximately 40 days in which there were observed the process parameters (temperature, ph, controlled pressure inside the installation) and it was determined the produced quantity of biogas and its partial composition in terms of methane and carbon dioxide.

The average temperature value during the process was 35 – 36 deg. Celsius, a good indicator for a mesophilic anaerobic digestion, while the pH was corrected using a caustic soda suspension at the beginning of the process, in order to obtain a pH value between 6.5 – 7.5. The pH values over the experimental part are presented in figure 2.

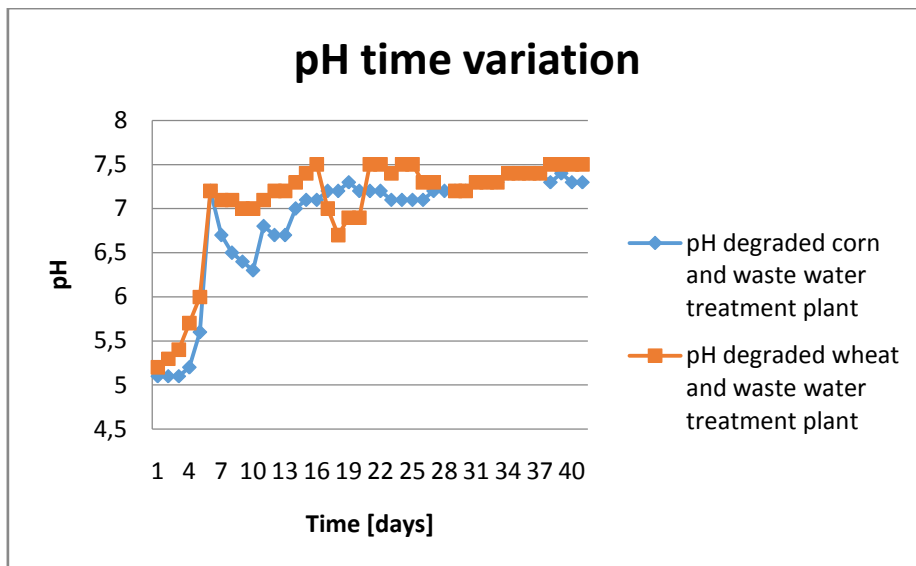

Figure 2. pH values for material batches.

It can be observed that with the exception of the first period (about 7 days), the values are inside the specified domain, having a neutral suspension inside both reactors, very suitable conditions for anaerobic fermentation. During the determination, also the quantity and quality of the produced biogas was monitored, the obtained values being presented in figure 3.

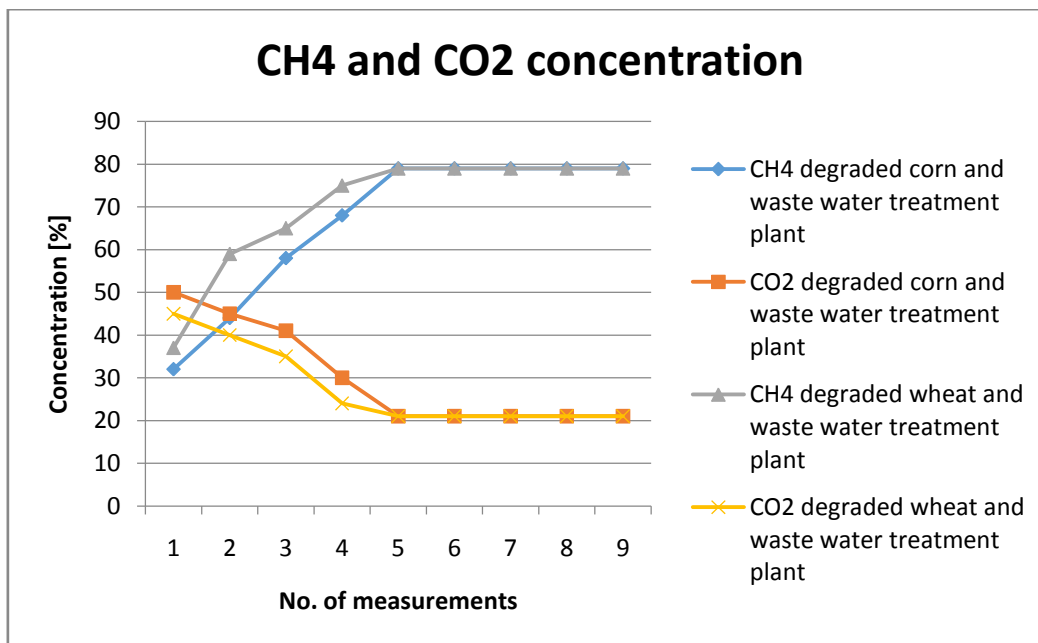

Figure 3. Partial composition of produced biogas.

From figure 3 one can determine that the methane concentration varies between 32% and 79 % for first batch (degraded corn) while the second batch had a minimum of 37% and a maximum of 79%. The carbon dioxide decreased to a value of about 21% for both batches. The only difference in behavior is related to the fact that the batch with degraded wheat arrived faster to a value of 79% than the batch with degraded corn.

## CONCLUSIONS

The present paper was a study conducted on two different cereal materials with impact over the quality and quantity of the produced biogas during a 40 day anaerobic fermentation process. From the obtained data, it was determined that the batch with degraded wheat had a better evolution during the process, both in terms of biogas quality and quantity (it produced about 19 cubic meters of biogas, while the batch with degraded corn produced about 13 cubic meters).

The determinations have as a main conclusion the fact that biogas is a suitable biofuel for firing applications, at least as complementary fuel for fossil ones, while using materials which for the moment exist in large quantities and have no other destinations (waste water has no immediate applications for the moment).

Further studies are needed in order to optimize the process and increase the quantity and quality of the produced biogas but the results are a good indicator that this process can be further used at larger scale, at least as pilot determinations.

## ACKNOWLEDGMENT

This work was supported by a grant of the Romanian National Authority for Scientific Research and Innovation, CNCS – UEFISCDI, project number PN-II-RU-TE-2014-4-1043.

## REFERENCES

- Busch G. et al, A New and Sound Technology for Biogas from Solid Waste and Biomass, *Water Air Soil Pollution*, 2009, pp. 89 – 97.
- Demirel, B., Scherer, P., (2008). The roles of acetotrophic and hydrogenotrophic methanogens during anaerobic conversion of biomass to methane: a review, *Reviews in Environmental Science and Biotechnology*, VII (2), 173 – 190.
- Mateescu C., (2008). Opportunities and barriers for development of biogas technologies in Romania, *Environmental Engineering and Management Journal*, VII (5), 603 – 607.
- Petersson A., Thomsen M.H., Hauggaard – Nielsen H., Thomsen A.B., Potential bioethanol and biogas production using lignocellulosic biomass from winter rye, oilseed rape and faba bean, *Biomass and Bioenergy*, No. 31, 2007, pp. 812–819.
- Petersen Jan-Erik - Energy production with agricultural biomass: environmental implications and analytical challenges, *European Review of Agricultural Economics*, Vol 35 (3), 2008.

**V International Conference  
„ECOLOGY OF URBAN AREAS“ 2016**

**SEGMENTS OF SUSTAINABLE DEVELOPMENT OF THE CITY  
OF ZRENJANIN**

**Mila Kavalić, Sanja Stanisavljev, Marko Vlahović, Branko Markoski, Erika Tobolka**

University of Novi Sad, Technical Faculty “Mihajlo Pupin”, Zrenjanin, Serbia  
milazakin@yahoo.com

**ABSTRACT**

This paper analyzes attitudes of citizens towards the importance of sustainable development in the City of Zrenjanin, and therefore for the community. Benefits gained by sustainable development in all spheres of life have been analyzed. This paper aims to point out that raising sustainable development in the City of Zrenjanin to a higher level, directly affects the economic and social factors of this city. Considering people's attitude towards sustainable development and its segments is highly important in order to estimate the level of people's awareness of different segments of sustainable development which directly affect life quality. Based on people's awareness about sustainable development, analysis shows which segments should be explained and to what extent it is necessary to raise human awareness about the given problems.

**Key words:** Sustainable development, sustainable economy, Zrenjanin.

**INTRODUCTION**

Given that Serbia is a developing country, it is in a constant race with global trends, which are aimed at the improvement of community development. Improving human community can only be achieved through sustainable development of individuals, community and economy on a larger scale. Although there is no unique and universally accepted definition of the concept of sustainable development, it is agreed that this concept needs to be introduced as well as the awareness of its' existence. One of the comprehensive definitions of sustainable development is: Sustainable development is an integral economic, technological, social and cultural development, complied with the needs of protection and improvement of the environment, which enables current and future generations to satisfy their needs and improve the life quality". (*Adams, 2006* ) The most common cited definition of sustainable development is given in the report "Our Common Future", which was, on the call of the United Nations, written by the World Commission on Environment and Development, the so-called Brundtland Commission (Brundtland Report) in 1987. (*United Nations, 1987*) The definition: "Sustainable development is development that meets the needs of the present without compromising the ability of future generations to meet their own needs". Investment in knowledge and sharing the same can affect weaknesses of a society which reflect in insufficient awareness of sustainable development. Also, this is how the individuals' activities could be focused on preservation of resources of a country in a sustainable way. Raising and directing awareness about sustainable economy which is based on environmental protection and social responsibility, allows us to create such organizational climate that is focused on sustainable way of operating from the very beginning of the cycle. Caring about the community becomes increasingly evident and enterprises pay more attention to this segment through both daily operations and concern about the community. Corporate social responsibility is observed through economic, social, environmental and ethical dimension. Enterprises that are socially responsible are more successful than enterprises which have not yet accepted or have just begun to adopt the concept of corporate social responsibility in their business through sustainable development (Slavić, M. 2015).

**TEORY**

Concept of sustainable development is a new paradigm, a new strategy and philosophy of social development. Sustainable development is not a static category but a whole process of changes and

adaptation which will make available resources, investments and technological advances consistent with current and future needs. The basic condition for the successful achievement of the given goals is to effectively manage their implementation. Contribution of particular sciences involved in the concept of sustainable development is not completely possible to specify because each of these sciences is making its contribution from its perspective (*Obradović & all, 2007*). A man is just a part of nature and has no rights to destroy it, reduce the resource wealth and undermines diversity of the living world. Earlier, companies considered that ecology is not their problem but merely profit. Now, sustainable development is accepted as well as the fact that people should invest in environmentally sound manufacturing and products, with preservation of the environment. In other words, disregard of the concept of sustainable development leads to inefficient economic development, in terms of greater waste of resources and energy (*Pešić, 2002*). The Municipality of Zrenjanin, like many others in Serbia, is faced with great problems in its development that have emerged as a result of impoverishment throughout decades, lack of resources and inadequate investment in development. In all cities in Serbia as well as in Zrenjanin, mission of every responsible government is, using the best of its potential and capability, to act for the benefit of its citizens (*Petrevska I. & all, 2007*). The regions which are evolving faster and possess a large number of different factors and have a better competitive position. Competitiveness is closely related to the increase in standard of living, greater employment opportunities, as well as the ability of the country (economy) to meet its international duties (*Vuković D. 2013, p.204*). The extent to which the local government is ready to meet the demands for the creation of better living conditions in its local community and efficiently solve everyday life problems of its citizens, shows to what extent the citizens showed respect and gained trust for the realization of development plans and goals, as well as for support and full responsibility of each individual in the process of rapid development of the local community. To effectively solve numerous problems, there has to be a clear vision of the development of the local community. In order to implement this vision adequately, it is necessary to make optimal decisions that should be in accordance with the strategy of sustainable development of local communities. Decision may relate to problems which can be defined clearly and objectively where decision-makers have all information for examining possible alternatives. Such decisions are referred to as optimal (*Pravdić P. & Marković, M., 2013*). Vision of quality directs strategic visions of every organization and public institutions (*Pavlović M., 2013*). The vision of the local community along with good decision-making, should serve as a guideline for the future that includes all subjects and members of local development.

## **METHODOLOGY**

### **The subject of the research and research problem**

The subject of this research is the assessment of sustainable development in the City of Zrenjanin. As in other cities in Serbia, so as in Zrenjanin, assessment of citizens' attitude towards sustainable development is a key feature that can be used as a basis for improving the development of individuals and entire community. The functioning of the City of Zrenjanin faces major problems in its development that have arisen as result of impoverishment throughout decades, lack of resources and inadequate investment in development. Therefore, assessing citizens' standpoint on a given issue is a problem that is addressed in this study.

### **Research objectives**

Research objectives are aimed at perceiving citizens' attitude towards sustainable development and its function in improving life quality of both the individual and the economy itself. The objectives of the research are directed towards evaluation of citizens' awareness of sustainable development, through the following segments: 1. Consideration of public awareness of sustainable development of the City of Zrenjanin. 2. Consideration of citizens' opinion whether it would be possible to raise awareness of sustainable development in the future 3. Evaluation of citizens' attitude towards the benefit of investment in sustainable development 4. Consideration of citizens' awareness of the connection between economic and social factors, and sustainable development 5. Consideration of citizens' awareness of the connection between the environment and sustainable development.

## Research methodology and organization

In order to know to what extent are citizens of Zrenjanin aware of the importance and segments of sustainable development, an empirical research was carried out. The research methodology is based on a survey on sustainable development (Zakin *et al.*, 2013). The questions were formulated to include respondents' perception on a given issue, i.e. basic statements, awareness and opinions. Claims are ranked according to the Likert scale, from completely disagree to strongly agree. Surveys are divided randomly, in order to evaluate awareness of people of different professional level and of different ages. The sample included 288 respondents. Information based on data from the surveys are statistically processed, after which the results were displayed on a graph in order to be easily understood.

## RESULTS AND DISCUSSION

Evaluation of public consciousness on sustainable development and its segments is essential in order to evaluate the level of people's awareness about various segments of sustainable development that directly affect the life quality. Based on how much people know about sustainable development, the analysis can show which segments should be considered first and to what extent it is necessary to raise awareness about the given issue. The following diagrams show answers to the given questions.

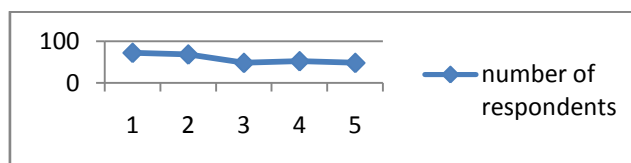

Figure 1. Citizens' awareness of what sustainable development is.

Based on the perceived information shown in Fig.1. (Figure 1), it can be concluded that the majority of respondents are not aware of what sustainable development actually represents. Fewer respondents said they are familiar with it but not sufficiently informed, while the lowest percentage declared that they are fully informed what is the meaning of the given term. Based on this, it can be concluded that it is necessary to inform the community about what sustainable development represents and what are its goals, in order for citizens to direct their activities towards that. Awareness can be raised through a variety of educational programs, workshops, actions, by introducing educational topics from the field of sustainable development in preschool and school education.

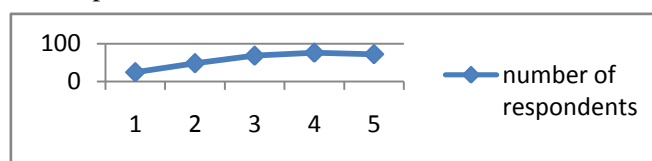

Figure 2. The importance of sustainable development for the Municipality of Zrenjanin.

Based on analyzed results which are shown in Fig.2. (Figure 2) it can be concluded that only a small number of respondents believe that sustainable development is not important for the Municipality of Zrenjanin. "Are you aware of what sustainable development represents?" is the question from the previous diagram to which the most of respondents answered that they are not informed. The following question was: "Do you consider that sustainable development is important for the Municipality of Zrenjanin?" Greater number of people answered positively, which is interesting given the fact what was their answer to the first question. It can be concluded that people, although not aware of what the term actually means, consider that its realization can positively affect better life quality of the city. People's will to accept that something is important for their surrounding is the opportunity to expand their awareness of the given topic.



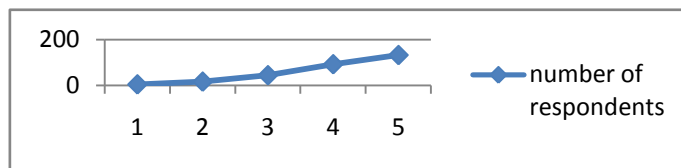

Figure 3. The impact of sustainable development on improving people's life quality.

Based on the analyzed results which are shown in Fig.3. (Figure 3) it can be seen that only a small number of respondents believe that investment in sustainable development does not improve the quality of life, while the majority believes that investment in it greatly affects the life quality. Although many people are not familiar with the term sustainable development, they consider that it improves life quality. Therefore, activities should be focused on people's awareness of all possible ways to influence the improvement of life quality.

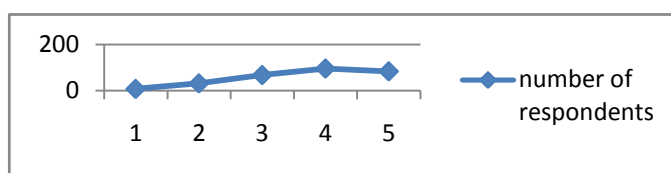

Figure 4. Impact of investment in sustainable development on the economic factors of the Municipality of Zrenjanin.

Based on analyzed results which are shown in Figure 4. (Figure 4) it can be concluded that only a small number of respondents believe that investment in sustainable development does not affect the economic factors of the Municipality of Zrenjanin, while the majority wasn't determined because they are not informed or consider that investment in it has a great impact. Although many people are not familiar with the term sustainable development, they do not have a negative attitude towards how it affects economic factors in the Municipality. Therefore, activities should be focused on people's awareness of all possible ways to contribute to economic factors. Also, people should be given exact cases which were carried out in the Municipality of Zrenjanin.

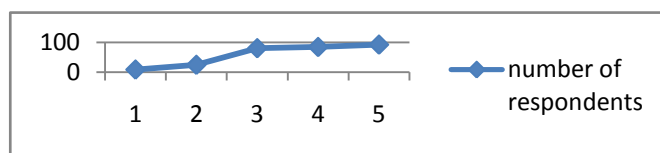

Figure 5. Impact of investment in the sustainable development on the social factors of the Municipality of Zrenjanin.

Based on the analyzed results which are shown in Figure 5. (Figure 5) it can be seen that only a small number of respondents believe that investment in sustainable development does not affect the social factors of the Municipality of Zrenjanin, while the majority wasn't determined because they are not informed or consider that investment has a great impact. Therefore, activities should be focused on people's awareness of all possible ways to contribute to social factors and what they represent. Also, people should be familiar with the exact cases that have so far played a part in the people's social life.

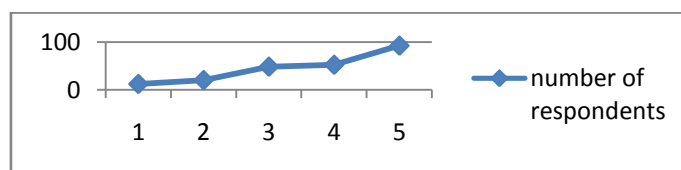

Figure 6. The impact of investment in the sustainable development on environmental protection in the Municipality of Zrenjanin.

Based on the analyzed results which are shown in Fig.6. (Figure 6) it can be concluded that only a small number of respondents believe that investment in sustainable development does not affect the environmental protection, while the majority wasn't determined because they are not informed or consider that investment has a great impact. Therefore, activities should be focused on people's awareness of all possible ways to contribute to environmental protection. Emphasis should be placed on highlighting the impact of such an environment, on the benefit of people.

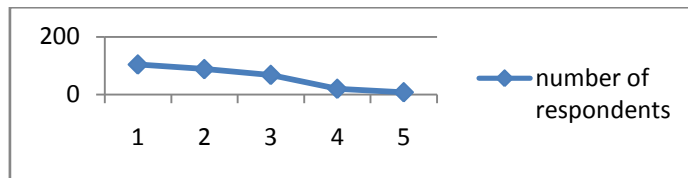

Figure 7. People's awareness of sustainable development.

Based on the analyzed results which are shown in Fig.7. (Figure 7) it can be seen that the majority of respondents stated that awareness of the sustainable development is not high enough, while a smaller number of respondents said the opposite. The fact that citizens are well aware of the fact that the level of their awareness is low, is the opportunity that should be used to implement concrete actions that encourage public awareness.

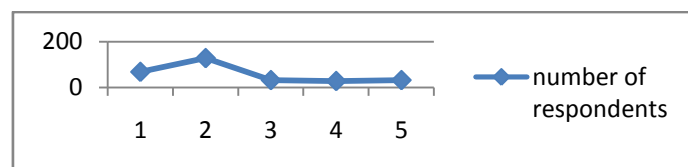

Figure 8. To what extent citizens contribute to sustainable development by their own actions.

Based on the analyzed results which are shown in Fig.8. (Figure 8), it can be concluded that the majority of respondents believe that their actions do not contribute enough or that they contribute insufficiently. Citizens should be focused on what ways each individual could contribute to such a development. Also, it should be predicted how much the contribution of each individual signifies on a city level.

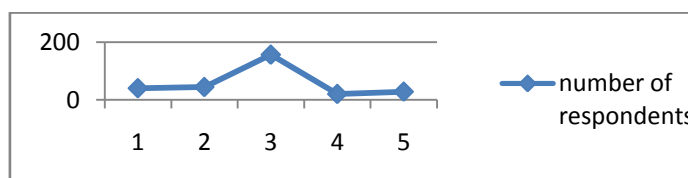

Figure 9. Changing people's consciousness on sustainable development in the near future

Based on the analyzed results which are shown in fig.9. it can be concluded that the majority of respondents were not sure whether there will be a change in consciousness. Assessment of surveyed citizens indicate that awareness of sustainable development will stagnate, and in order to prevent that, analysis shows that the state is the most responsible and that it should, by certain laws, promotions and education, emphasize the importance of sustainable development.

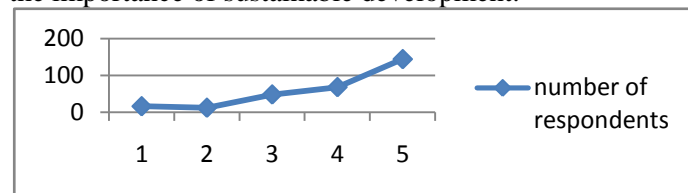

Figure 10. Better understanding of sustainable development when the state motivates individuals.

Based on the analyzed results which are shown in Fig 10. it can be concluded that the majority of respondents think that it is necessary that state motivates individuals in order for people to understand sustainable development in a better way. The state should motivate individuals by various promotional materials, constant informing about the benefits of investing in sustainable development. Also, it is necessary to point out which actions were carried out and how did they affect the sustainable development of the City of Zrenjanin and better life conditions of its inhabitants.

## CONCLUSION

Based on the conducted survey, it can be said that people's awareness of sustainable development is not fully developed. Although citizens are not completely aware of what sustainable development represents, they perceive it as important for the City of Zrenjanin and they think that investments in it affect people's life quality, contribute to the protection of the environment, and positively influence social and economic factors. Raising awareness of sustainable development in the City of Zrenjanin and therefore in the Republic of Serbia, would directly affect the preservation of natural resources and raising the standard of living which would result in improved life quality. Alignment with EU legislation requires the urgency of establishing a coherent policy of the state in this field and the integration of the required measures. If the management of sustainable development is considered seriously, it would result in drastic changes that would lead to better functioning of the local community in many areas. Not only do they have to change our habits, but to change the consciousness concerning the environment. Only with a positive attitude and by accepting changes that are necessary to improve sustainable development, the Municipality of Zrenjanin can experience success in many fields.

## REFERENCES

- Adams , W. M. (2006 ) , The Future of Sustainability , Kragujevac , P.204
- JOVANCAI, A., & STEVANOVIĆ, A. T. (2013). UTICAJ OBRAZOVANJA RADNE SNAGE NA KONKURENTNOST PREDUZEĆA I PRIVREDNI RAST. *Megatrend Review*, 10(4).
- Obradovic M. , Stankovic D. , Obradovic , S., (2007 ) , professional work "Harmony of Ecology and Sustainable Development " , FORESTRY 1-2 , Belgrade , Faculty of Forestry p.12-14
- Pavlovic M. , (2013) . Integrated Management Systems , Technical Faculty " Mihajlo Pupin " , Zrenjanin
- Pesic, R., (2002 ) , Sustainable Development - The emergence of the concept of sustainable development " , Chapter I, Economics of natural resources and the environment. Belgrade , Faculty of Agriculture,
- Petrevska I., Zakin M., Šešlija M., Petrevski B.: "CITIZENS AWARENESS ABOUT SUSTAINABLE DEVELOPMENT OF THE CITY ZRENJANIN", 17th International Conference ICDQM-2014 „DEPENDABILITY AND QUALITY MANAGEMENT“, 27-28 jun 2014, Belgrade, Serbia., pp 253-260, ISBN 978-86-85355-16-4
- Pravdić P., Markovic , M., (2013) . Process management in the contemporary business magazine Trends in Business , Business College of Professional Studies ' Professor . Radomir Bojković " , ISSN (Reprinted ed.) 2334 - 8166X , ISSN ( Online ) 2334-8356 , p.31 - 41st
- Re - thinking Environmentand Development in the Twenty -first Century
- Report of the IUCN (2006 ) Renowned Thinkers Meeting, 29-31 January ,
- Slavić, M. (2015). Društveno odgovorno poslovanje i društvena odgovornost menadžmenta. Sustainable development strategy Zrenjanin
- United Nations , (1987 ) , Report of the World Commission on Environmental Development , General Assembly Resolution 42/187, 11 December in 1987.
- Vukovic D. (2013) . Correlation analysis of regional competitiveness INDICATORS : EXAMPLE OF THE REPUBLIC OF SERBIAN , Journal of Economic Horizons
- Zaki M., I. Petkanić, Litričin LJ., (2013) Student Work - Sustainable development in the municipality of Zrenjanin, Zrenjanin

## **ELECTRO AND ELECTRO-MAGNETIC POLLUTION IN URBAN AREAS**

V International Conference  
„ECOLOGY OF URBAN AREAS“ 2016

**THE CONCEPT OF A POWER PLANT BASED ON THE SEEBECK –  
PELTIER EFFECT**

**Cătălin – Virgil Rădulescu<sup>1</sup>, Ioana Ionel<sup>1\*</sup>**

<sup>1</sup> Politehnica University of Timisoara, Faculty for Mechanical Engineering,  
Mihai Viteazu Blvd., No.1, 300222, Timisoara, Romania  
r\_catalin52@yahoo.com, \*ioana.ionel@upt.ro

**ABSTRACT**

*This paper deals with a practical achievement of the direct "Seebeck - Peltier" thermoelectric effect, which consists of the emergence of a thermoelectric voltages in a circuit composed of two or more semiconductors, whose contacts are maintained at different temperature levels. The core of the experiment is a thermoelectric module that consists of several pn type semiconductors junctions, sized 38 x 38 mm, operating at a voltage of 12 V, and a power of 72 W. To generate electricity, the piece must be cooled, thus it creates a temperature difference of the temperatures (DT), which is directly proportional to the voltage generated by the module thermoelectric. The stand runs temperatures up to 260 – 360 °C, in order to obtain a temperature gradient DT = 100-200 °C. Cooling the other side of the piece is ensured. In conclusion, the paper presents an application in the field of thermoelectric clean energy generation, and the concept of a power plant that generates electricity. The originality lies in the concept of the stand, its practical realization, experiments and interpretation of the up to now achieved results, and identification of potential application and future trends in the development.*

**Key words:** *thermoelectric effect, clean electricity, power plant.*

**INTRODUCTION**

**Basics**

The first of the thermoelectric effects was discovered in 1821 by T. J. Seebeck, who demonstrated that an electromotive force could be produced by heating the junction between two different electrical conductors/wires. If the junction between the wires is heated, it is found that the meter records a small voltage. The arrangement is shown in Figure 1. The two wires are forming a thermocouple. The magnitude of the thermoelectric voltage is proportional to the difference between the temperature at the thermocouple junction and that at the connections to the voltage meter.

Efficient thermoelectric power conversion requires four key components: (1) thermoelectric materials, (2) thermoelectric modules, (3) active cooling and (4) a heat source. All are integrated in an interface system using auxiliary parts for distributing and storing the resulting electrical power. Figure 1 represents a thermoelectric module and the specific outline of the p-n pellets. TEG (Thermoelectric generator) module is delivered by selecting its characteristics, and has a graphite foil thermal interface material (TIM) pre-applied to both sides.

These devices utilize the Seebeck effect (the opposite of the Peltier effect) to generate electrical energy. The only requirement is that each face of the device must be exposed to different temperatures; a "hot" side and a "cold" side. The greater the temperature difference, the more power generated. All thermoelectric devices will generate different levels of electric power, but the power generation efficiency can reach 6 % with 300 °C on the hot side, and 25 °C or cooler, on the cold side.

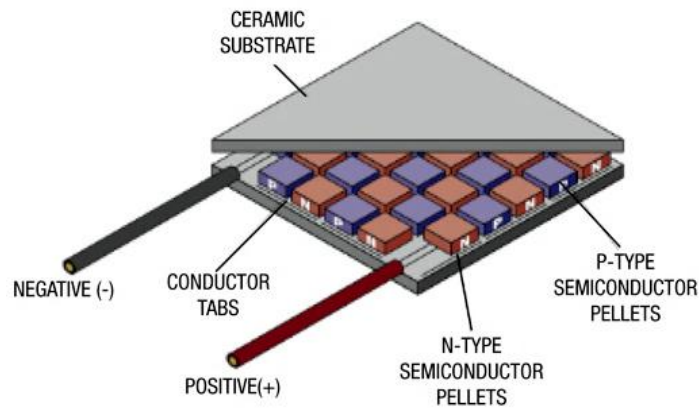

Figure 1. Outfit of a TEG (product offered, for ex through [www.digikey.com](http://www.digikey.com) and others)

A plan with the components and concept are illustrated in Figure 2. For cooling of the cold surface, it is recommended to use an integrated cooling system with recirculation of a cooling agent, thus maintaining a constant temperature on the cold side.

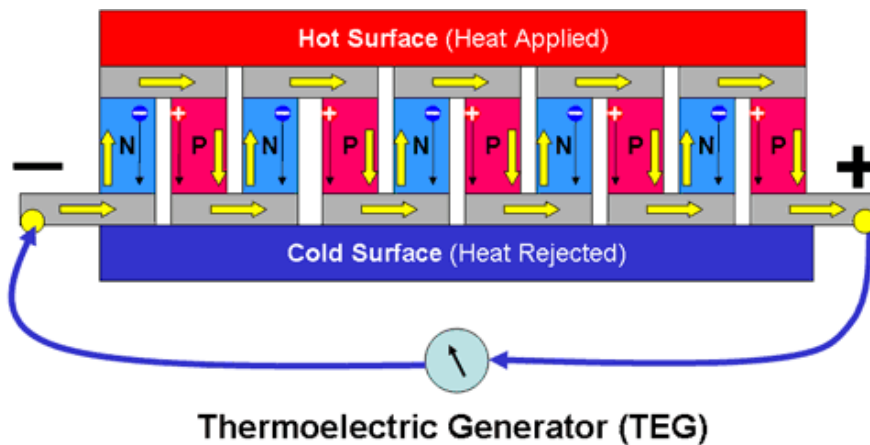

Figure 2. Schematics of a TEG (Thermoelectric generator), according [www.mpoweruk.com](http://www.mpoweruk.com) Thermoelectric Generator Development for Automotive Waste Heat Recovery

A thermoelectric (TE) generator produces electric power directly from a temperature gradient through TE material (according Hee Seok Kim et al. 2015). Thus, the authors indicate that the maximum efficiency of a TE generator was first derived based on a constant property model by Altenkirch by 1909, and its optimized formula, commonly used, is as follows (Eq. 1):

$$\eta_{max} = \frac{\Delta T}{T_h} \frac{\sqrt{1 + Z \cdot T_{avg}} - 1}{\sqrt{1 + Z \cdot T_{avg}} + \frac{T_c}{T_h}} \quad (1)$$

where  $T_h$  and  $T_c$  are the hot- and cold-side temperatures, respectively, and  $\Delta T$  and  $T_{avg}$  are their difference,  $T_h - T_c$ , and average  $(T_h + T_c)/2$ , respectively. The TE conversion efficiency is the product of the Carnot efficiency ( $\Delta T/T_h$ ) and a reduction factor as a function of the material's figure of merit  $Z = S^2 \rho^{-1} \kappa^{-1}$ , where  $S$ ,  $\rho$ , and  $\kappa$  are the Seebeck coefficient, electrical resistivity, and thermal conductivity, respectively. The dimensionless figure of merit ( $ZT$ ), such as the peak  $ZT$  and the average  $ZT$ , has been used as the guide to achieve better materials for higher conversion efficiency. Thirteen years after, J. Peltier, observed the second of the thermoelectric effects. He found that the passage of an electric current through a thermocouple produces a small heating or cooling effect

depending on its direction. The Peltier effect is quite difficult to demonstrate using metallic thermocouples since it is always accompanied by the Joule heating effect. Sometimes, one can do no better than show that there is less heating when the current is passed in one direction rather than the other. If one uses the arrangement shown in Figure 1, the Peltier effect can be demonstrated, in principle, by replacing the meter with a direct current source and by placing a small thermometer on the thermocouple junction.

It seems that it was not immediately realised that the Seebeck and Peltier phenomena are dependent on one another. However, this interdependency was recognised by W. Thomson (who later became Lord Kelvin), in 1855. By applying the theory of thermodynamics to the problem, he was able to establish a relationship between the coefficients that describe the Seebeck and Peltier effects. His theory also showed that there must be a third thermoelectric effect, which exists in a homogeneous conductor. This effect, now known as the Thomson effect, consists of reversible heating or cooling when there is both a flow of electric current and a temperature gradient.

## RECENT RESEARCH AND DEVELOPMENT

Clean energy is absolutely necessary to be used in this century. Thermoelectric energy conversion using Thermo-Electric Generators (T.E.G.) or modules has countless applications in which it could be integrated. One of those is part of a wide spread automotive market, as every car has its exhaust system that can capture the excess heat generated by the functioning motor and convert it into clean energy using T.E.G modules. There are many pioneers that have managed to come up with such a system. One of them is conceived by Gregory P. Meisner; he successfully obtained electrical power equivalent to 1 KW, using T.E.G modules and exhaust heat generated from a working motor. More information is to be found under “Thermoelectric Generator Development for Automotive Waste Heat Recovery”, G.M. Global Research & Development 2010 (*Gregory P. Meisner et al, 2011*).

Implementing this technology into various applications is very easy, new compact designs can be created that can transfer heat to T.E.G modules with ease. With more advanced cooling methods, more advanced materials we can design more efficient modules that can generate more power withstanding greater temperatures.

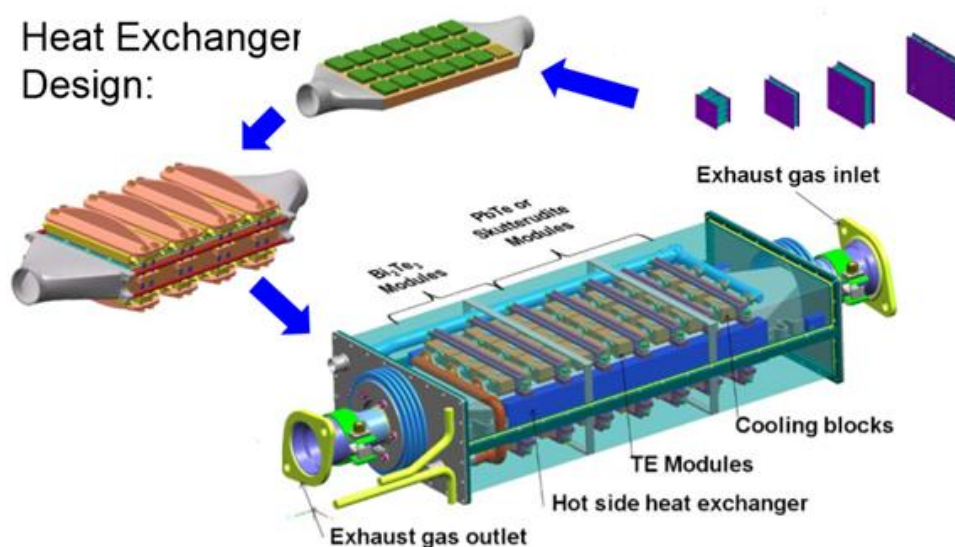

Figure 3. Schematics of the Thermoelectric Generator Development for Automotive Waste Heat Recovery, (according G.M. Global Research & Development 2010, *Gregory P. Meisner et al, 2011*)

In Figure 3 a heat exchanger design is illustrated, the  $\text{Bi}_2\text{Te}_3$  modules are mounted towards near the gas outlet while the more superior “Skutterudite” modules are found near the inlet where far greater temperatures are present.

$\text{Bi}_2\text{Te}_3$  is Bismuth-Telluride, a material with good thermoelectric proprieties, is widely used (Ex: in T.E.C modules), withstanding temperatures up to  $130^\circ\text{C}$ . PbTe or skutterudite is a material more superior to bismuth telluride that can hold its Seebeck coefficient under high temperatures up to  $400^\circ\text{C}$  or more.

D. Sugantha Priya and al, 2015, deal with similar research, indicating many possibilities for waste heat recovery, of special interest.

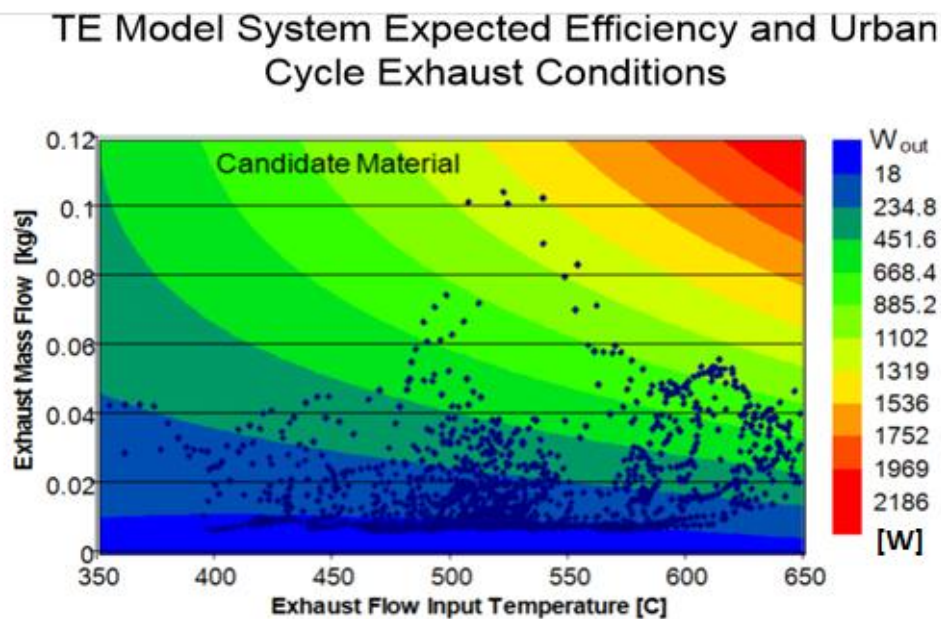

Figure 4. Functioning characteristics of an exhaust T.E.G system,

“Thermoelectric Generator Development for Automotive Waste Heat Recovery”,

G.M. Global Research & Development 2010

([https://www1.eere.energy.gov/vehiclesandfuels/pdfs/thermoelectrics\\_app\\_2011/monday/meisner.pdf](https://www1.eere.energy.gov/vehiclesandfuels/pdfs/thermoelectrics_app_2011/monday/meisner.pdf))

Figure 4 gives an example of a potential heat recovery result, and the values, expressed in W, for the electrical output  $W_{\text{out}}$ , applying thermoelectric recovery (depending on the temperatures of the exhaust flow and the mass flow).

Furthermore, literature indicates that typical internal combustion engines lose about 75 % of the fuel energy through the engine coolant, exhaust and surface radiation (Jasdeep S. Conde, 2012). Most of the heat generated comes from converting the chemical energy in the fuel to mechanical energy and in turn thermal energy is produced. In general, the thermal energy is unutilized and thus wasted. His report describes the analysis of a novel waste heat recovery (WHR) system that operates on a Rankine cycle, but it is very tempting to exploit this generous hot temperature waste heat. The same idea is presented by Fr. P. Brito et al. (2010).



## Testing facility for T.E.G module and results

A T.E.G. testing assembly was designed, using the following selected components:

- Computer C.P.U cooling system (with the recalculating agent: water), composed of its heat exchange unit, fan, water block with water pump and copper plate. The system is designed for computer processor cooling; the copper plate ensures a good contact with the cold side of the T.E.G module.
- Mounting base (a wooden plate for easy mounting and placement).
- Mounting brackets, nuts and bolts (easy interlocking).
- Heat sync for quick heat exchange between the heat source and hot side of T.E.G. module.

The core of the experiment is a thermoelectric module (T.E.C. 12706 model) that consists of several pn type semiconductors junctions, sized 38 x 38 mm, operating at a voltage of 12 V, and a power of 72 W. To generate electricity, the piece must be cooled, thus it creates a temperature difference of the temperatures ( $\Delta T$ ), which is directly proportional to the voltage generated by the module thermoelectric. The stand runs temperatures up to 260 – 360 °C, in order to obtain a temperature gradient  $\Delta T = 100\text{-}200$  °C. Figure 5 is an illustration of the testing facility.

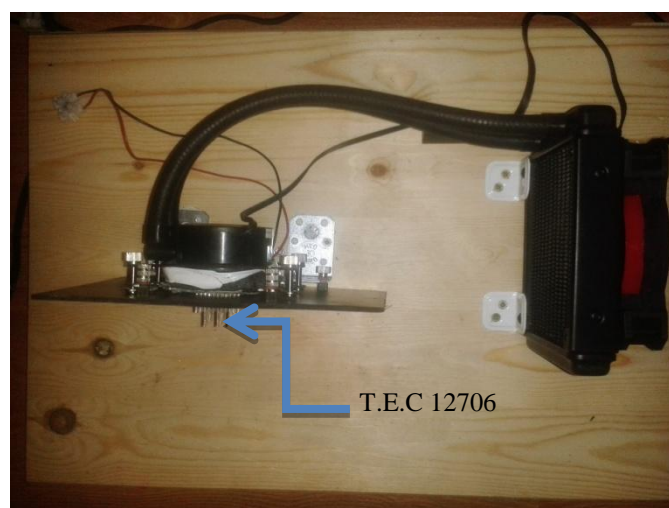

*Figure 5. Test facility. First version (July 2016)*

The testing platform and device is user friendly, offering the possibility to an easy change between different types of modules, different sizes and other selections. One managed to test the thermoelectric cooling module T.E.C. 12706, that is different from the T.E.G module because of its purpose and material, basically its designed for cooling applications and the maximum working temperature is lower compared to T.E.G's, 120 °C.

## TEST RESULTS AND FUTURE WORK

For initial testing one has chosen a T.E.C. module because of its cheaper price and availability on the market. The  $\Delta T$  is the temperature difference between the two sides of the T.E.C. module.  $U$  is the electricity output in Volts (see Figure 6). Figure 7 represents the temperatures of each side of the T.E.C module at different outputs.  $mT_c$  stands for hot temperature, and  $mT_r$  stands for cold temperature.

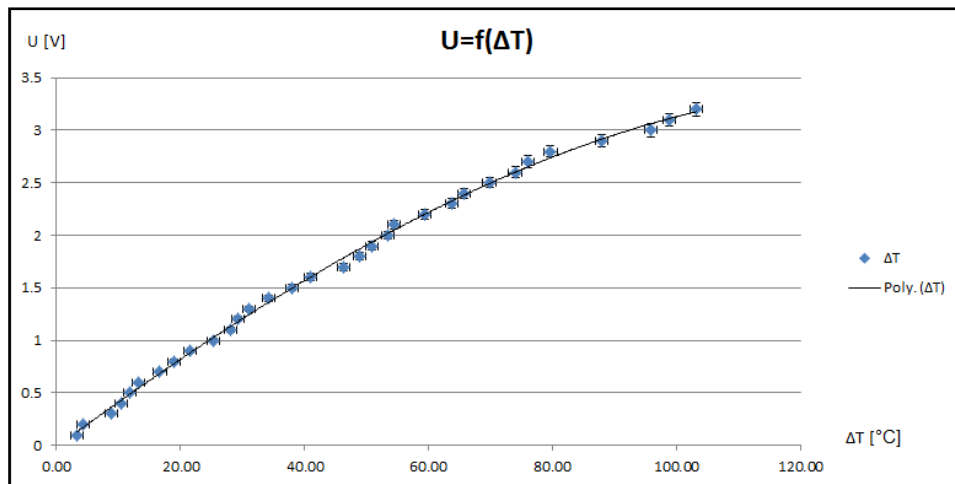

Figure 6. Electrical output of T.E.C 12706 in relation to  $\Delta T$  the temperature difference, as achieved during the tests

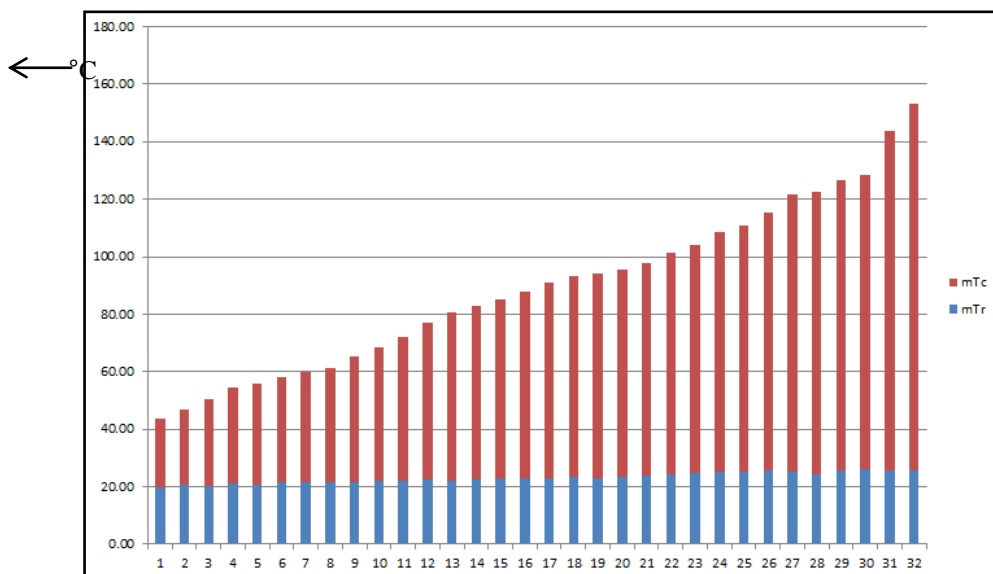

Figure 7. Temperatures of each side of the T.E.C module at different outputs ( $mT_c$  stands for hot temperature, and  $mT_r$  stands for cold temperature).

Up to now, one run several rounds of testing with a 0.1 Volts rate, and, for each unit, one measured three temperature readings, for each hot side and cold side. It results that the facility can be used for low temperature conversion of heat to electrical power. Its output is levelled at 3 V and around 0.363 Amperes, and these values can be raised by connecting the units in a particular way.

Further work consists of using a more costly TEG plate, and run tests also for recovering real hot gases, such as from household applications or vehicles exhaust.

## CONCLUSIONS

The paper presents a first attempt of heat recovery demonstration using a TEG, with the purpose to build a clean electric plant, capable to offer electric supply from waste heat. Its originality lies in the concept of the stand, its practical realization, experiments and interpretation of the up to now achieved results, and identification of potential application and future trends in the development.

## ACKNOWLEDGEMENT

This work was developed as sustainability activity, carried out by the authors, for the project *PRACTICOR EURO-REGIO* POSDRU/161/2.1/G/132889 (Regional and Euro-regional partnership for the transition to the labour market through career counselling and internships at employer), and POSDRU/90/2.1/S/48816, *PRACTICOR* (Educational transnational network on guidance, counselling and career practice correlated with the labour market in the knowledge society). Also, the advises from *Mr Stoica Virgil* are to be mentioned.

## REFERENCES

- \*\*\*, [www.mpoweruk.com](http://www.mpoweruk.com), *Thermoelectric Generator Development for Automotive Waste Heat Recovery*, accessed ay 2016.
- Hee Seok Kim, Weishu Liu, Gang Chen, Ching-Wu Chu, and Zhifeng Ren, Relationship between thermoelectric figure of merit and energy conversion efficiency, *Proc Natl Acad Sci U S A*. 2015 Jul 7; 112(27): 8205–8210, Published online 2015 Jun 22. doi: 10.1073/pnas.1510231112.
- G. P. Meisner, *Advanced Thermoelectric Materials and Generator Technology for Automotive Waste Heat at GM, General Motors Global Research & Development Warren, MI, 2011 Thermoelectric Applications Workshop, January 3-6, 2011*,  
[https://www1.eere.energy.gov/vehiclesandfuels/pdfs/thermoelectrics\\_app\\_2011/monday/meisner.pdf](https://www1.eere.energy.gov/vehiclesandfuels/pdfs/thermoelectrics_app_2011/monday/meisner.pdf)
- Hee Seok Kim, Weishu Liu, Gang Chen, Ching-Wu Chu, and Zhifeng Ren, Relationship between thermoelectric figure of merit and energy conversion efficiency, *Proc Natl Acad Sci U S A*. 2015 Jul 7; 112(27): 8205–8210, Published online 2015 Jun 22. doi: 10.1073/pnas.1510231112
- D. Sugantha Priya, M. Varatharaj, Thermoelectric power generator by recovery heat from engine exhaust (research script), *IJRME*, Volume 02, issue 03, 2015
- Jasdeep S. Condle, Analysis of a novel waste heat recovery mechanism for an i.c. engine, Report, Michigan Technological University, 2012
- Fr. P. Brito, J. Martins, L.M. Goncalves and R. Sousa, Temperature Controlled Exhaust Heat Thermoelectric Generation, 2012-01-1214, Published 04/16/2012, Universidade do Minho, Copyright © 2012 SAE International, doi:10.4271/2012-01-1214

V International Conference  
„ECOLOGY OF URBAN AREAS“2016

**POSSIBILITIES OF VALUABLE RAW MATERIAL EXTRACTION IN  
THE PROCESS OF RECYCLING OF REFRIGERATORS**

**Tijana Marinković<sup>1\*</sup>, Bojan Batinić<sup>1</sup>, Una Marčeta<sup>2</sup>, Mladenka Novaković<sup>1</sup>, Čedomir  
Ribić<sup>1</sup>**

<sup>1</sup>University of Novi Sad, Faculty of Technical Sciences, Novi Sad, Republic of Serbia

<sup>2</sup>University of Novi Sad, Technical Faculty “Mihajlo Pupin”, Zrenjanin, Republic of Serbia  
tijanamarinkovic@uns.ac.rs

**ABSTRACT**

*This paper describes the main characteristics of waste of electrical and electronic equipment (WEEE), the quantity of the waste and legislation in the field of WEEE. The main part deals with the description of the technological flow of recycling of electrical and electronic waste, with particular focus on the recycling of refrigerators. The main raw materials created in refrigerators recycling process are copper, aluminum, iron and plastic. The main advantages of recycling are related to reduction of environmental pollution, consumption of natural resources, less cost of processing plants and energy saving up to 95%.*

**Key words:** *Electrical and electronic waste, recycling, refrigerators.*

**INTRODUCTION**

Certain types of electrical and electronic devices may contain more than 100 different substances that fall within the category of hazardous and non-hazardous waste and therefore, they are managed differently. E-waste recycling leads to significant energy savings because a part of technological process, that is required in the processing of natural raw materials such as mining, flotation, crude oil refining and other, is skipped (Bowcock, 2011).

The aim of this work is to analyze the technological process flow of electronic and electrical waste, starting from sorting and dismantling through mechanical treatment and the extraction of metals from waste. A special emphasis is put on recycling of refrigerators which require specific treatment. The goal is to evaluate the efficiency of recycling refrigerator waste in terms of determining the quantity of recycled materials which can be extracted in certain stages of the process, in order to point out that this method of obtaining raw materials saves energy.

**CHARACTERISTICS AND AMOUNT OF WEEE**

Electrical and electronic equipment can be defined as a product whose proper operation depends on electrical current and electromagnetic field. Besides, that equipment along with the one used for producing, transmitting and measuring flow of current and field can be divided into separate classes based on voltage used, and it is used on voltages which do not exceeding 1000V for alternate current and 1500V for direct current. According to Directive 2012/19/EC, when electrical and electronic equipment becomes useless, it becomes WEEE, which needs to be managed. Waste from electrical and electronic equipment, including equipment and devices that the owner wants to get rid off as well as the components originating from the industry.

**Characteristics of electrical and electronic waste**

Electronic and electrical waste is characterized as hazardous waste and according to the Law on Waste Management ("Official Gazette of RS", no. 36/2009 and 88/2010) it is classified into special waste

flows. Waste Management Law lays down regulations by which this waste cannot be mixed with other types of waste.

Rule book ("Official Gazette of RS", no. 99/2010) defines 10 categories of electric and electronic waste which are classified by different classes of electrical and electronic equipment. These 10 categories are: Large home appliances, Small home appliances, IT and telecommunications equipment, Entertainment equipment, Lightning equipment, Electric and electronic tools, Toys, recreation, Medical aid equipment, Surveillance equipment, Automates/Wending machines.

### **The amount of electrical and electronic waste and equipment in EU**

Analyses show that in EU countries the share of electronic waste in the total amount of municipal waste in the early 80s of the last century was around 2%, or 4 million tons per year. In the late 90s the amount of this type of waste has increased to 6 million tons per year i.e. per share of 4% of the total amount of waste. The expected increase in the amount of electronic waste in the European Union is 5% per annum, which indicates that by the end of this decade, the amount of this waste type will have been doubled (Ivanović et al., 2012).

### **LEGISLATION**

After more than a decade of careful consideration, EU manufacturers and the government have adopted a system of producer responsibility as the best and fairest mechanism to solve the problem of e-waste in Europe. This is reflected in the WEEE and RoHS Directives. They are already implemented in more than 20 countries across the EU.

The target area of these Directives, which are implemented along with the laws that aim to reduce energy consumption and other negative issues, are different impacts that the product may have during its life cycle. When dealing with problems, each Directive puts an emphasis on the producers who are expected to solve those issues by using ecological design (Curcic et al., 2015).

Law on Waste Management provides that the waste electronic and electrical devices must be collected separately for their treatment. In addition, all liquids from old electrical appliances must be separated and treated in the prescribed manner ("Official Gazette of RS", no. 36/2009 and 88/2010). Cooling devices (freezers and refrigerators) shall be comprised of liquids and gases, so they are subject to this law.

### **AVAILABLE METHODS (TECHNOLOGIES) FOR THE TREATMENT OF ELECTRONIC AND ELECTRICAL WASTE**

The existence of a functioning system of waste management of electrical and electronic devices is to achieve the necessary preconditions for the prevention of the generation, reuse, recycling and other forms of utilization of such waste, as well as to reduce its disposal to landfill (Pavlović et al., 2011).

#### **Recycling**

Recycling of electrical and electronic waste creates valuable secondary raw materials. Also, e-waste recycling ensures that harmful substances are well managed which contributes to protection of the environment. E-waste recycling is an important topic not only from the point of waste treatment but also for the recovery of valuable materials. It is estimated that the e-waste has about 10% of proper parts, 5% can be recycled and reused and the remaining 85% must be dismantled and sorted, then used. Generally, it is not justified to continue to use proper parts and assemblies of discarded devices that are older than three years. Recycling sized devices is facilitated due to less diversity of materials and easier extraction (level of efficiency is even up to 85%) (Namias, 2013).

E-waste recycling process takes place respectively in the following three steps:

1. Collecting;
2. Sorting / dismantling (validation, classification and dismantling), mechanical treatment (including shredding, dismantling, magnetic separation);
3. Final processing (metal separation and disposal).

### **Collecting**

WEEE Directive aims to improve e-waste management through:

- Selective collecting of e-waste using appropriate systems that preserve the integrity of the devices and their potential for renewal;
- The collecting rate, which each Member must reach, which is 4 kg of e-waste per resident annually.

Collecting is mainly carried out at regional or national level, and is achieved through "take-back" programs supported by shopping malls (e-equipment vendors) and manufacturers, municipal centers or profit and non-profit organizations.

### **Sorting and dismantling**

The level of previous mechanical treatment directly affects which e-waste would be treated in the final processing, as well as the amount of metal that can be extracted. Before the treatment it is necessary to remove components that contain precious metals. There are two types of dismantle processes: manual and automated. Manual dismantling has been proven to be the most effective method (Opalić et al., 2010).

### **Mechanical treatment**

Mechanical and physic-mechanical treatment of e-waste can be automated and generally consists of the following stages (Grujić et al., 2006):

1. Primary reduction in volume using multi rotating blades;
2. Magnetic separation;
3. Dismantling using impact crusher mills;
4. Classification of particles using sieve Electrostatic separation (Eddy currents);
5. Gravity separation for plastic extraction;
6. Additional size reduction.

#### ***Primary volume reduction***

Great diversity of materials used in the production of electronic devices directly affects the complexity of the technology of mechanical recycling of these products. The technology of mechanical recycling can be divided into two parts. Those are shredding and material separation. In order to achieve successful recycling, shredding process must ensure material release. During this section, material objects are separated into material fractions. The whole device is shredded by chopping up parts from 10 cm<sup>2</sup> or less (Trumić et al., 2012).

#### ***Separation of metal and plastic***

The most common methods of separation in the process of electronic devices recycling are (Kang et al., 2005):

1. Magnetic separation;
2. Separation based on differences in density - a gravity concentration;
3. Separation based on the electrostatic conductivity.

## **Final treatment**

The aim of this step is to recover valuable components (precious metals, rare metals) and remove impurities.

Pyrometallurgical methods include processing in furnaces at high temperatures to separate the metal from mullock, which is removed in the form of dross. Hydrometallurgical processes are a set of processes that are used to produce useful components (metals or compounds). Here, aqueous solution of acid, base or salt is used for extraction. Bio-metallurgical process is based on mutual interaction of microorganisms and metals, which provides the energy necessary for functioning. That interaction includes sorption, reduction, oxidation and deposition (Lenhard, 2008). Electrometallurgical processes include electrode processes and can be carried out both in aqueous solutions at low temperatures as well as at elevated temperatures in the molten salt (Namias, 2013).

## **RECYCLING OF REFRIGERATORS**

The aim of recycling and regeneration of cooling matter is lowering the level or complete removal of impurities from cooling substances.

### **Description of recycling process**

In order to describe refrigerators recycling process, current treatment practice in company “JUGO-IMPEX e.e.r.” from Serbia, was analyzed. Firstly, by the procedure of dismantling, components such as wood, glass, cables, switches with mercury are removed from the refrigerator. This is followed by suction (chloro - fluoro - carbon) of CFC and extraction of compressor. A special vacuum machine is used to remove Freon. When Freon is isolated from the device, it is transported to the main machine in querstromzerspaner (QZ) facility via the input conveyor. The main part of QZ is a powerful engine that drives massive chains that shred the material (MeWa, 2011).

High kinetic energy is produced by two chains that are attached to the shaft. Chains also rotate and, with different number of rpm, break material on its components. Metal components in input material cut softer ones, such as plastic, wood, polyurethane (PU) foam and others. The percentage of oxygen in this part of the process and subsequent stages remains controlled at the level below 5%. After 240 seconds of treatment, material is sent to drying. During transportation through special vertical screw conveyors, material is heated on the temperature of 80° C in order to remove the moisture from the shredded material. Then it is transmitted to "screen machines" which have special vibrating sieves. At this point, "PU powder" is separated from the material residue. Polyurethane powder is then transported by means of special "matrices" which temperature is 120° C. High temperature is the most suitable because it perfectly extracts all "pollutants" (Freon) from "PU powder" in a form of steam. From already mentioned "matrices", clear "PU powder" is transported into special sacks where it is stored until CFC gases evaporations don't turn into liquid, using cryogenic condensation. Residue from "screen machine" is transported to a magnetic separator using belt conveyor. This separator segregates magnetic parts from incoming material. "Fero material" falls on the conveyor from where it is transported to the receiving container. The rest of the waste is segregated by special separator called "Eddy current" which gives two fractions: plastics and non-metals (MeWa, 2011).

### **Material flow analysis of electrical refrigerator waste dismantling**

The main output from the process of dismantling are power cords, compressor, Freon, drawers, seals and glass shelves. These parts make 18.6% of the total recycled weight (Zhang, 2011).

Dismantling process does not affect the environment and does not generate any solid waste, water waste, gases or noise. Waste that could not be manually dismantled is processed through cutting / shredding and separation. Then, useful and secondary raw materials are extracted from it. Most of the material is extracted in the process of dismantling and separation, and they make 69.2% of the total

weight recycled (Zhang, 2011). A lot of noise is produced during the grinding process. Besides, separation process generates solid waste and residue. In addition, micro-particles formed during grinding and separation are harmful to the environment. The total amount of recycled cooling devices is 12.2% of the total mass. Material flow in each step expressed in tons is shown in Table 1. (Zhang, 2011).

*Table 1: Material flow in each step expressed in tons (Zhang, 2011)*

Step	Dismantling		Shredding and separation		Recovery resources for cooling	
	Weight (t)	Contribution (%)	Weight (t)	Contribution (%)	Weight (t)	Contribution (%)
PVC	0.081	43.55	0.009	1.30	0	0.00
Aluminum	0.005	2.69	0.09	13.01	0.005	4.10
Copper	0.006	3.23	0.108	15.61	0.006	4.92
Iron	0.026	13.98	0.468	67.63	0.026	21.31
Other	0.068	36.56	0.017	2.46	0.085	69.67
Sum	0.186		0.692		0.122	

Based on research (Zhang, 2012), after all phases of recycling are finished and materials separated, data on quantity of that separated material is obtained. Analysis of material flow for the entire recycling process of fridges is shown in Table 2.

*Table 2: Analysis of material flow for the entire recycling process shown for 1 ton of discarded fridges (Zhang, 2011)*

Material	Weight (t)	Contribution (%)
PVC	0.09	9
Aluminum	0.10	10
Copper	0.12	12
Iron	0.52	52
Other	0.17	17

Metal and energy consumption has a worrisome pace of growth. The world is running out of reserves. Metal scrap is a very significant secondary resource, whose collecting and re-processing significantly reduce the consumption of primary raw materials, extend the existence of their reserves and reduce environmental pollution. Figure 1 shows energy savings if recycled material is being used instead of materials from their natural source (Cui, 2005).

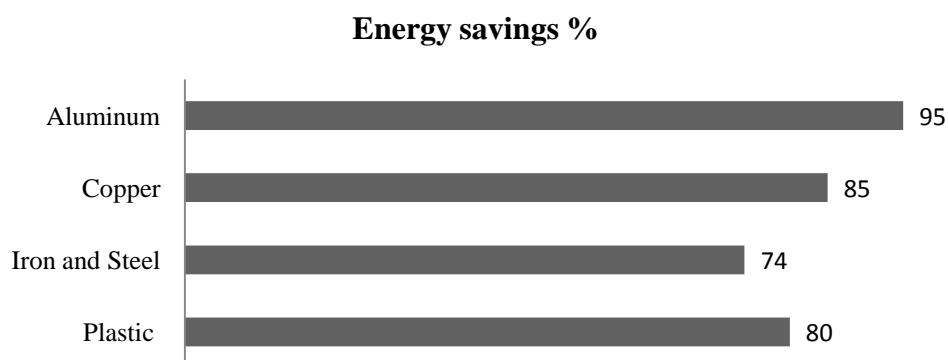

*Figure 1: Percentage of energy saving if e-waste is recycled, in relation to obtaining raw materials from natural sources (Cui, 2005)*



## CONCLUSION

Constant society improvement causes rapid development of modern technologies which leads to the increased production and use of various electrical devices and equipment. What makes electronic and electrical waste hazardous is the fact that it contains toxic and carcinogenic substances. Besides harmful substances, e-waste contains precious metals such as gold, platinum, copper, aluminum and others. The aim of the final treatment is to recover valuable components (precious metals, rare metals) and remove impurities. Copper is the most common metal in electronics because of its high electrical conductivity.

Recycling of refrigerators and other cooling devices is essential and carefully carried out, unlike other e-waste recycling because they contain Freon. Problems in refrigerator recycling may arise in the process of grinding / shredding because it produces dust and causes noise.

There is an automated facility in Serbia which achieved to minimize the problems by using special technological solutions. The possibility of extracting Freon from cooling system and isolated mass of devices is over 90%. Through several processes of shredding, sorting and separation, this facility gives the purest fractions of output material (iron, plastics, non-ferrous metal, polyurethane granulates - "PU powder").

In general, recycling of one ton of refrigerators gives 90 kg of PVC, 100 kg of aluminum, 120 kg of copper, 520 kg of iron and 170 kg is residue. When extracting materials by recycling of refrigerator waste, the percentage of saved energy in relation to the amount of energy that would be spent if metals and raw materials would be extracted from ore, is high.. Metal scrap is very significant secondary resource, whose collecting and re-processing significantly reduce the consumption of primary raw materials, extend the existence of their reserves and reduce environmental pollution. Investment costs for the construction of waste treatment plants and metal production have a share of only 16 to 20 % of the costs required for the construction of a plant for the processing of primary raw materials - ore. After recycling, reuse of metals from e-waste can be achieved only by integrated approach towards the problem, and the future which seeks sustainable development.

## REFERENCES

- Bowcock, H., (2011). Electrical and electronic waste. *Balkan Network for Advocacy on Electronic Waste*, Niš
- Directive 2012/19/ EC on waste electrical and electronic equipment (WEEE). European Parliament and Council (2012). . Official Journal of the European Union
- (The law waste management"Official Gazette of RS", no. 36/2009 and 88/2010)
- Ordinance on the list of electrical and electronic products, prohibition measures and restrictions on the use of electrical and electronic equipment containing hazardous substances, manner and procedure for management of waste from electrical and electronic products ("Official Gazette of RS", no. 99/2010)
- Ivanović, L., Josifović, D., Stojanović, B., Ilić, A., (2012). Improving the design of equipment for the recycling of electronic waste. *39th National Conference on quality*, Kragujevac, A-276 - A-286.
- Curcic, S., Pavlović, M., Arsovki, S., Pavlović, A., Tomovic, A., (2015). EU Directive in the management of electronic waste EU. *42. National Conference on quality*, Karagujevac, A-268 A-272.
- Pavlović, V., Tadic, V., Popović, M., (2012) Sustainable management of e-waste in Serbia. *Civil society organizations as a bridge of communication between citizens, public authorities and the business sector in the management of waste from electronic and electrical products*, Belgrade.
- Namias, J., (2013). The future of electronic waste recycling in the united states: Obstacles and Domestic Solutions. *Department of Earth and Environmental Engineering*, Columbia University, New York, Columbia.
- Opalić, M., Kljajin M., Vuckovic, K., (2010). Disassembly Layout in WEEE Recycling Process, *Faculty of Mechanical Engineering and Naval Architecture*, University of Zagreb 52 (1): 51-58.
- Grujić, B., Dostanić, M., (2006). Recycling of electronic products. *1st National Conference on quality of life*, Kragujevac, B100- B103.
- Trumić, M., May, E. T., (2012). The role of the preparations in the recycling of waste and the sustainable development of Serbia. *7. Symposium "Recycling Technologies and Sustainable Development"*. Bor.

- Kang, H., Schoenung, M. J., (2005) Electronic waste recycling: A review of U.S. infrastructure and technology options. *Conservation and Recycling* 45 (2005): 368–400
- Lenhard, Z., (2008). Metallurgy of non-ferrous metals I. Faculty of Metallurgy, Sisak, Croatia.
- Cui J. (2005). Mechanical Recycling of Consumer Electronic Scrap, Lulea University of Technology, Lulea, Sweden.
- Zhang, R., (2011). Cases of Material Flow Analysis for Electronic Manufacturers and Waste Electrical Appliance Dismantlers. *Improving Resource Efficiency for the Production and Recycling of Electronic Products by Adoption of Waste Tracking System*, Environmental Management College of China, 80 – 87.
- Andritz MeWa, 2011. Recycling technologies Individual designs. Optimal solutions.  
[www.andritz.com/mewa](http://www.andritz.com/mewa) (2016/7/24)

## **ACCIDENTS IN URBAN AREAS**

V International Conference  
„ECOLOGY OF URBAN AREAS“ 2016

**ACCIDENTAL EVENTS OF PRIMARY SHORT-CIRCUIT OF  
ELECTRICAL INSTALLATIONS – FORENSIC ANALYSIS**

**V.M. Zorić<sup>1,2,\*</sup>, S.S. Dmitrašinović<sup>1</sup>, V. Petrović<sup>3</sup>, M. Vojinović Miloradov<sup>4</sup>,  
I. Mihajlović<sup>4</sup>, V. Sajfert<sup>5</sup>**

<sup>1</sup> University of Novi Sad, Faculty of Sciences, Trg Dositeja Obradovića 4, Novi Sad, Serbia

<sup>2</sup> Ministry of Interior Affairs of Serbia, CPD-National Forensic Center, Kneza Miloša 103, Belgrade, Serbia

<sup>3</sup> Higher Technical School of Professional Studies in Novi Sad, Školska 1, Novi Sad, Serbia

<sup>4</sup> University of Novi Sad, Faculty of Technical Sciences, Trg Dositeja Obradovića 6, Novi Sad, Serbia

<sup>5</sup> University of Novi Sad, Technical Faculty Mihajlo Pupin, Đure Đakovića bb, Zrenjanin, Serbia

vzorice@df.uns.ac.rs, sonjad@dh.uns.ac.rs, vojkan.zoric@mup.gov.rs, petrovic.v@vtsns.edu.rs

miloradov@uns.ac.rs, ivanamihajlovic@uns.ac.rs, sajfertv@open.telekom.rs

**ABSTRACT**

*In recent years, in Serbia the tendency of increasing the fire on buildings and motor vehicles caused by inoperative or old and used-up electrical installations has been observed. In addition, the material damages as a consequences of the primary short-circuit of electrical installations, could generate extremely serious air and water pollution by emerging volatile compounds and hydrophobic and hydrophylic substances especially of aquatic media. During these accidents, it is very important to determine whether the fire was the result of the short circuit - primary or secondary cause of the fire. In order to give an answer to this question, it is necessary to perform very subtle and sensitive forensic analysis of traces from the incidence. Proper detection of traces of the ashes, and their fixing for the laboratory analysis, it could be determined whether the tested conductors break is rich in oxygen, thus proving that it is a primary short ie. a short circuit which is the cause of a fire. This paper has a twofold objectives: first, that the described methodology and approach help to prevent the occurrence of such accidents and the second the educational task engaged in determining the causes of accident.*

**Key words:** *primary short-circuit, electrical installations, forensic analysis.*

**INTRODUCTION**

Statistical data (Blagojevic, 2013) on the location where the fire resulted as the consequence of electrical failure include the following objects:

- Conductors that are embedded in the facilities (over 33%),
- Cables and plugs (near 20%)
- Lamps and various light sources (about 20%)
- Switches, extension cables and sockets (over 10%)
- Fuses, main switches, distribution boards (about 5%)
- Measurement devices and their enclosures
- Power transformers
- Other places within electrical switchboard.

Each electric current value corresponding to a certain increase in temperature, which must be limited, ie. the temperature should not be higher than insulation flashpoint of surrounding objects and materials. The materials in the immediate vicinity may be different: insulation, structural elements of the buildings, any other inflammable and explosive materials.

The most common causes of ignition associated with electricity are: overheating of electrical wires, coils and other devices through which flows an electric current, short circuit, large transient resistance, arcing and failures to electrothermal devices. Overheating of conductors can occur even in normal

power loads, if in some way heat dissipation is prevented. Any preventing the release of heat into the surrounding atmosphere, overlapping edge isolation with different materials, which may create some form of external thermal insulation, can cause burning of power cable even under normal load current. In practice, poor quality and overloaded extension cords usually burning. If specific smell of rubber is developed in isolation overheating, it is important fact for expertise.

Burning of insulation could also be caused by transition resistances of low quality. In that cases the places where wires are connected to the places of their merger with tables, machines, devices and appliances are intensely heated and oxidation of the transition resistances creates conditions for the release of heat. This phenomenon is especially pronounced where the conductors are not made of copper. Various earthquakes and vibrations can contribute to loose contacts and to has a great resistance, which results in local heating and promotes the oxidation process. Accumulation of emerging metal oxide indicates lower conductivity and rise of resistance at contact site which causes the heat release. The temperature at the contact site increases and the energy dissipation increases until the moment the conditions for the ignition of flammable material are reached in the immediate vicinity.

A large transition resistances are particularly the cause of the large number of fires in cases where merging without soldering or without the use of regular terminals, but only the free combination and duct tape compounds are performed by unqualified persons. In these cases, at the current of 10 A, the temperature reaches from 50 to 90 ° C and at 20 A goes to 130 ° C and even up to 300 ° C, which may cause ignition of not only the contact, but also at distance of a few centimeters from the contact due to arcing. This can lead to ignition of various materials, such as:

- Materials of low thermal inertness: sheets, blankets, pillows, etc., if installed near the socket - the power dissipation required for ignition is 28 W,
- Components of the electrical installation made of plastic - the power dissipation required for ignition is 30 W,
- Products made of wood - the power dissipation required for ignition is 35 to 50 W,
- Components of conductor made of aluminum - power dissipation required to burn 45 to 50 W.

Based on the report of the Center of Fire Statistics (2010), which was made in 2010, the greatest number of fires occurred in buildings and motor vehicles, almost 50% of all other facilities and locations. For example, Belgrade is on a very high place based on the statistics number of the fire accidents in capital cities (Table 1). Number of fires in buildings and motor vehicles, according to statistics from 2010, compared to a population of 1,000 people, ranking Belgrade at a very high place (over 50%) comparing to other capital cities (Table 2).

Table 1. Distribution of fires by origin in the cities of the world in 2010  
(Center of Fire Statistics, 2010)

N	City	Number of fires ...															
		Buildings	In %	Chimneys	in %	Out of buildings	in %	Vehicle	in %	Forests	in %	Grass, brush	in %	Rubbish	in %	Other	in %
1	Belgrad	1 418	41,1	102	3,0	-	-	452	13,1	12	0,3	216	6,3	861	24,9	390	11,3
2	Bratislava	198	22,4	2	0,2	-	-	147	16,6	0	0,0	72	8,1	361	40,8	105	11,9
3	Bucharest	737	53,7	53	3,9	-	-	163	11,9	0	0,0	0	0,0	0	0,0	420	30,6
4	Budapest	1 112	53,2	-	-	-	-	483	23,1	-	-	479	22,9	-	-	18	0,9
5	Copenhagen	-	-	-	-	-	-	267	14,8	-	-	58	3,2	578	32,0	904	50,0
6	Helsinki	620	50,3	2	0,2	-	-	201	16,3	25	2,0	98	8,0	3	0,2	283	23,0
7	Kiev	2 645	77,3	-	-	1197	25,9	326	7,1	346	10,1	-	-	-	-	104	3,0
8	Ljubljana	189	36,2	30	5,7	-	-	89	17,0	7	1,3	15	2,9	136	26,1	56	10,7
9	Minsk	3 417	77,6	-	-	-	-	165	3,7	0	0,0	0	0,0	-	-	823	18,7
10	Moscow	6 400	77,6	-	-	-	-	1 705	20,7	-	-	-	-	-	-	141	1,7
11	Riga	1 300	52,3	38	1,5	-	-	124	5,0	14	0,6	254	10,2	573	23,1	181	7,3
12	Sofia	400	13,5	16	0,5	-	-	309	10,4	2	0,1	426	14,4	26	0,9	1 780	60,2
13	Tallinn	446	16,9	2	0,1	-	-	66	2,5	-	-	266	10,1	1 073	40,7	786	29,8
14	Vilnius	387	25,6	56	3,7	-	-	202	13,4	8	0,5	144	9,5	655	43,3	60	4,0
15	Warsaw	1 532	34,6	21	0,5	-	-	374	8,4	50	1,1	390	8,8	1 375	31,0	692	15,6
16	Wellington	443	59,1	-	-	-	-	63	8,4	1	0,1	44	5,9	-	-	198	26,4
17	Zagreb	262	22,5	38	3,3	-	-	113	9,7	17	1,5	365	31,4	49	4,2	318	27,4
Total:		21 506	48,3	360	0,8	1 197	2,7	5 249	11,8	482	1,1	2 827	6,3	5 641	12,7	7 259	16,3

Table 2. Distribution of the cities by the number of fires in buildings and motor vehicles in 2010 (Compared to a population of 1,000 people.) (Center of Fire Statistics, 2010)

N	City	Population thous.inh.	Structure and vehicle fires	Part of all fires, %	Fire deaths	Structure and vehicle fires per 1.000 inh.	Fire deaths per 100.000 inh.	Fire deaths per 100 fires
1	Tokyo	12 222	3 623	71,2	95	0,3	0,8	2,6
2	Moscow	11 514	8 105	99,1	224	0,7	1,9	2,8
3	Kiev	2 792	2 971	64,3	67	1,1	2,4	2,3
4	Bucharest	1 943	953	69,4	20	0,5	1,0	2,1
5	Budapest	1 733	1 595	76,2	23	0,9	1,3	1,4
6	Belgrad	1 731	1 979	57,2	10	1,1	0,6	0,5
7	Warsaw	1 714	1 927	43,5	15	1,1	0,9	0,8
8	Sofia	1 291	725	24,5	10	0,6	0,8	1,4
9	Zagreb	792	413	35,5	3	0,5	0,4	0,7
10	Riga	700	1 462	58,9	41	2,1	5,9	2,8
11	Helsinki	589	823	67,2	6	1,4	1,0	0,7
12	Oslo	587	506	67,6	6	0,9	1,0	1,2
13	Vilnius	554	645	42,4	25	1,2	4,5	3,9
14	Bratislava	433	347	35,7	2	0,8	0,5	0,6
15	Tallinn	398	512	20,0	8	1,3	2,0	1,6
16	Ljubljana	280	308	59,0	0	1,1	0,0	0,0
Total:		39 273	26 894	68,4	555	0,7	1,4	2,1

N-number

Sparks and electric arc are very common cause of the fire. Sparking is even more dangerous in the vicinity of flammable and explosive materials. Electric arc usually has a temperature of 1500 - 4000 °C in the range and burned any material by contact or radiation. The most common causes of ignition are: interruption of the circuit on various devices or by mechanical force, as a side effect of electric welding or cutting the metals, loose contacts, sparks in electrical machines (collector, slip rings,

brushes), damage of insulation and contact with deposited conductors on a small distance or close to a ground structure or touching the bare wires (without insulation).

Very often on the ashes of the disaster are electric cookers, heaters, stoves, irons and improvised devices for heating which can cause a fire by heating its surface if it is hot and if brought into contact with the material that could burn. This equipment could cause fire if it is located in the center of the fire or in the vicinity of a material that can burn. Heating surface must provide sufficient heat to ignite the material.

Overloading the electric motors occurs most often from the following reasons: due to improper engine choice for the performance of the assignment, due to the negligence of the operator, and due to the failure of the mechanism that drives the motor. If the three-phase electric motor is powered by a two-stage, its rate greatly decreases, and the current intensity is increased so much that in the cases without safe protection, insulation of the stator or motor ignites. It is very dangerous for electric motors working at full load. The situation of engine is running on two phases may occur due to: a fuse in the supply network of motor, malfunction on the contact of one phase in the motor coupling, interruption of one phase in the supply circuit of the engine, scuffing and engine shaft, seizing and galling the mechanism that drives the electric motor. The most common of these phenomena is due to the presence of foreign objects in the ventilation duct.

The primary short-circuit occurs in air, in an environment that is rich in oxygen and this is a cause of the fire. Secondary short-circuit occurs in the absence of air (oxygen), but in the presence of nitrogen as well as gaseous combustion products, CO and other emerging gases.

Primary short-circuit is the most common cause of the fire to electrical installations. A typical trace of a short circuit is melted conductor and other parts of the installation and the device as a result of the arc, the temperature range from 1500 to 4000 °C. Melting usually has the appearance of beads formed by melting the metal wires or other parts, through which passes an electric current. In addition, the end of the conductor from his forehead has a smooth surface and rounded shape.

The melting of the conductor that occurs due to a short circuit is different from the melting that occurs due to the effect of heat during the fire. The surface of conductor melting by the fire looks like it's covered with tiny shells. When cables and parts are made of aluminum, it is almost impossible to determine traces of a short circuit, because the melting point of aluminum is around 660 °C, and the average flame temperature is 800 -1100 °C, so these parts have melted and very often burned in the fire.

Short circuits are usually caused by damaged insulation of the conductors. The destruction of insulation could be caused by mechanical damage, aging, constant and systematic overload, effects of humidity and aggressive chemical agents. During the fire accident, from the plastic material, emerging gases are generated and released in the surrounding atmosphere.

If a short circuit caused the fire, very strong current flowed through a conductor for a long time until the short circuit happened, which can be calculated from the length of the conductor, cross-section and specific resistance of the material. The existence of local boiling on the site of short circuit provides, under certain circumstances, a very important fact to resolve its character. For example, when there is a short circuit in the chamber of the roof pillar, or in the connecting tubular conductors on their upper narrow parts (cover), a larger amount of well is coated by copper (I) oxide,  $\text{Cu}_2\text{O}$  layer. The hot gases resulting from the primary short circuit with metal vapor going up because cold air pushes them. If secondary short circuit happened, there is no flow of hot gases as at the primary short-circuit, and a layer on copper conductors at sites around the short circuit has a completely different composition.

Since in Serbia is increasing the fire on buildings and motor vehicles, in the paper will be presented two case studies with forensic analysis. Based on the experimental results of the peaks in diffractogram ie. the peak of Cu or Cu<sub>2</sub>O could be predicted if the cause of the fire is by primary or secondary short-circuit on electrical installations. During the fire, different emerging substances were generated and released in atmosphere (volatile emerging substances, siloxane, VOCs and others) or in soil and water (hydrophylic emerging substances), as the very hazard contaminants. This type of case studies with experimental results is the very rare, sensitive and subtle.

### Theory for prediction of primary and secondary short-circuit on electrical installations

X-ray diffraction is used for identification of metal composition and could be performed by one of three methods, which are based on the diffraction of waves on the crystals:

1. Von Laue method - single crystal irradiated with X-ray of continuous spectrum.

2. Bragg's method - the crystal which rotates is illuminated by monochromatic radiation. Reflection occurs only at certain angles which gives information on distance between the planes of the crystal.

3. Debye-Scherrer method, monochromatic X-radiation is directed to polycrystalline sample spinning in a fixed cylindrical camera as a detector, in which the photographic film is placed.

If the electron is accelerated in an electric field, in a collision with the anode, X-ray radiation is emitted. Huygens - Fresnel principle is used for interference and diffraction of electromagnetic waves. Each point of wavefront acts as a source of secondary waves which can interfere with each other. The waves will always reflect on crystal lattice in such a way that the angle at which they approach the barrier equals the angle at which they reflect off the barrier (<https://www.pmf.ac.me/Download.php>).

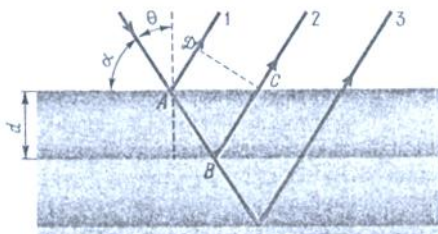

Figure 1. X-ray interference (<https://www.pmf.ac.me/Download.php>)

The waves shown in the figure 1 are coherent. If the phase difference between the reflected waves is  $2\pi$ , it leads to amplification of the reflected waves. The optical path difference is given by equation:

$$\Delta = |AB| + |BC| - |AD| = 2d \cos \theta \quad (1)$$

The phase difference is:

$$\delta = k\Delta = \frac{2\pi}{\lambda} \Delta \quad (2)$$

and amplification is in case of  $\delta = 2\pi m, (m = 0, 1, 2, \dots)$ . Increase in the intensity of the reflected wave is given by Bragg's equation :

$$2d \cos \theta = m\lambda \quad (3)$$



where  $d$  is the distance between the planes of the crystal. Previous diffraction methods have proven electromagnetic nature of X-ray radiation and possibility to determine its wavelength as the distance between the planes of the crystal.

The motion of a material point is described by the impulse (vector)  $\vec{P} = \left( p_x, p_y, p_z, \frac{iE}{c} \right)$  while movement of the plane wave with wave vector  $\vec{K} = \left( k_x, k_y, k_z, \frac{i\omega}{c} \right)$ . Relativistic invariance is given by expression:

$$\vec{P} = \hbar \vec{K} \quad (4)$$

where  $\hbar = 1.05 \cdot 10^{-34} \text{ Js}$  is Planck's constant.

Equations  $E = \hbar \omega$  and  $\vec{P} = \hbar \vec{K}$  linking particle and wave properties and are known as De Broglie relations. If the particle is presented as a plane wave, then it is described by a wave function

$$\Psi(\vec{r}, t) = A e^{-i(\omega t - \vec{k}\vec{r})} = A e^{-\frac{i}{\hbar}(Et - \vec{p}\vec{r})} \quad (5)$$

The phase velocity of the wave is the velocity of wave components at a constant wave phase  $Et - \vec{p}\vec{r} = \text{const.}$  and is expressed by eq.:

$$v_f = \frac{dx}{dt} = \frac{E}{p} = \frac{c^2}{v} \quad (6)$$

As the phase velocity is not characterized by the transfer of mass and energy, the previous equation is not inconsistent with the theory of relativity. Transfer of mass and energy is described by the group velocity of waves. Group wave with wave number  $k_0 - \varepsilon, k_0 + \varepsilon$  is described with the equation:

$$\Psi(x, t) = \frac{1}{2\pi} \int_{-\infty}^{\infty} A(k) e^{-i[\omega(k)t - kx]} dk \quad (7)$$

Development of  $\omega(k)$  in Taylor series around  $k_0$  and holding the first member of the development, gives the following eq:

$$\omega(k) = \omega_0 + (k - k_0) \frac{d\omega_0}{dk_0} \quad (8)$$

Wave packet in the first approximation is expressed without changing the shape:

$$\Psi(x, t) = \Psi\left(x - \frac{d\omega_0}{dk_0} t, 0\right) \cdot \exp\left[-i\left(\omega_0 - k_0 \frac{d\omega_0}{dk_0}\right)t\right] \quad (9)$$

Group velocity of waves is obtained from:

$$\frac{d}{dt}\left(x - \frac{d\omega_0}{dk_0} t\right) = 0 \quad (10)$$

and is given by eq.:

$$v_g = \frac{d\omega}{dk} = \frac{dE}{dp} = \frac{d\left(c\sqrt{p^2 + m_0^2 c^2}\right)}{dp} = v \quad (11)$$

This brief theoretical review is useful for understanding accidental events with experimental laboratory analyses of fire sources.

## MATERIAL AND METHODS

### X-ray structural analysis of short circuit

X-ray structural analysis is one of methods for analysis if the fire is caused by a short circuit in a conductor. This method is used for expertise of fires and is applied to the wires and cables without metal braid whose length is greater than 30-35 mm (Artamonov et al, 2007).

The concept of X-ray structural analysis is based on the following: if a short circuit is the primary, the atmosphere is rich in oxygen (oxic conditions) and in the field of warming occurs mainly copper (I) oxide ( $\text{Cu}_2\text{O}$ ). Before testing, wire was washed well with ethyl alcohol, and wiped with gauze to remove the copper (I) oxide which is soluble in an alcohol. This is necessary to avoid the presence of reflections from its planes 002 and 200, which would have covered line with the plane 111 of copper (I) oxide. After washing, the separation of samples is carried out. Sealed bead was separated and metallographic examination is made, followed by a separation of the two samples according to figure 2. The first sample is taken immediately after the sealed bead (5 mm in length), while the second at a distance of 30-35 mm from the sealed bead. As a result of X-ray analysis by Debye-Scherer method obtained peaks corresponding to radiograph distances between planes of Cu (for the plane (111)  $d/n = 2.1/5$ ) and  $\text{Cu}_2\text{O}$  (for the plane (111)  $d/n = 2.08$ ). They correspond to the corners of  $2\theta = 35,70^\circ$  i  $2\theta = 44,30^\circ$ , Figure 3. According to the ratio of the peaks intensity ( $I\text{-Cu}_2\text{O}/I\text{-Cu}$ ) could be determined whether the short circuit is primary or secondary. Namely, if the ratio of the sample 1 compared with sample 2 is greater than two times, it indicates primary short circuit. But, if this relationship in the sample 1 is two or more times lower than in sample 2, it could be concluded that secondary short-circuit happened. If smaller difference of intensity occurs, it is necessary to continue testing with metallographic methods.

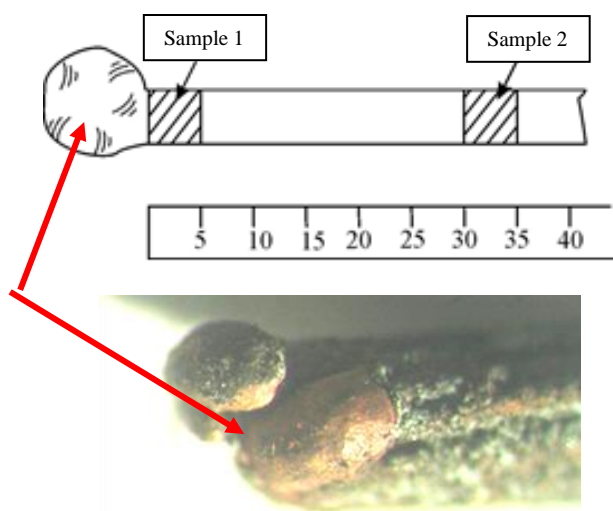

Figure 2. Samples of metallic conductors for R analysis

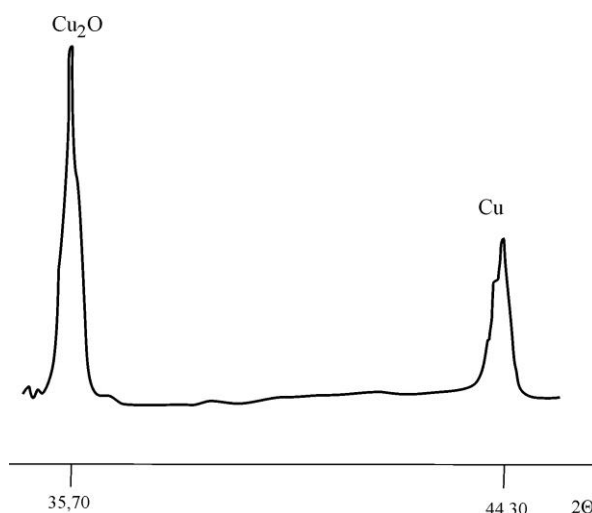

Figure 3. The peaks of  $\text{Cu}_2\text{O}$  i Cu in diffractogram

In our research activities, it was investigated only regular electric arc that occurs in a single conductor, as consequence of the overloading of the cable (passing the current of higher value than the conductor could withstand). Single-strand copper wire with diameter of 1.038 mm is attached to the wooden platform and it was fed with a current from transformer via potentiometer. The current that is passed through the conductor was measured with current clamps.

It was established that the current of 80 A indicates short circuit after a few minutes. When the necessary current strength and time after which short circuit occurs were determined, short circuit under different conditions was examined.

In the first case, a short circuit is caused in the air which would correspond to the formation of a primary short circuit. The other experiment was conducted in an atmosphere of visible suspension of carbon and other particles in air (smoke) and products of combustion, which should simulate a secondary short circuit. Then, X-ray structural analysis of the conductor was performed according to the described modified methodology (Artamonov et al, 2007).

## RESULTS AND DISCUSSION

Radiographs of copper wires that were short-circuited, obtained by structural analysis, are shown in Figure 4. Figure 4-1 represents a radiograph of a sample in which the conductor is caused by a short circuit in the air and it represents the primary short circuit. In this sample is registered only peak corresponding to copper (Cu), and the complete absence of peak of copper (I) oxide ( $\text{Cu}_2\text{O}$ ). It's very important to emphasize that under these conditions there was a short circuit after 1min and 24 s. In real terms before achieving such a high-value of electricity, conductor would be exposed for a long time to electricity of lower intensity that would be heated the conductor and as a result enabled the process of precrystallization.

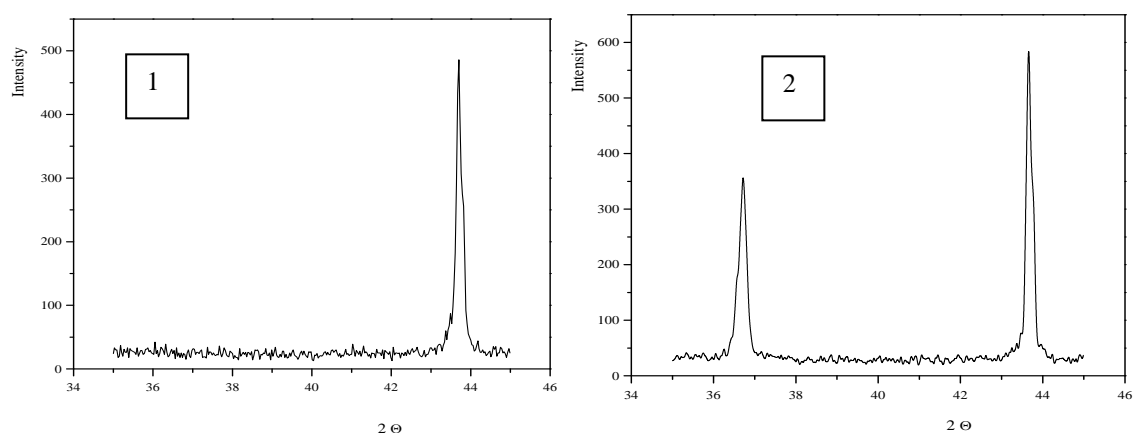

Figure 4. The diffraction pattern in the primary (1) and secondary (2) short-circuit

In figure 4-2 is presented the radiogram of conductor in which short circuit is caused in an atmosphere of fire and „smoke“. Even if, in this case, the same value of current ( $I = 80 \text{ A}$ ) was used, more time (6 min) was necessary to induce short circuit. Two peaks were registered at  $2\theta = 36,72^\circ$  and  $2\theta = 43,70^\circ$ . The analysis showed that these peaks originate the first from copper and the second from copper (I) oxide. Deviations from the angle values for copper and copper (I) oxide given in the literature [4] could be the result of using modified method of X-ray analysis. In this case, it is registered that the peak intensity of copper is higher than the intensity of copper - oxide ( $I\text{-Cu} > I\text{-Cu}_2\text{O}$ ). This result could be due to the atmosphere of smoke where there was not enough oxygen for the formation of larger amounts of  $\text{Cu}_2\text{O}$ , so prevalent is Cu.

### Case studies

In the last few years, there are more fires on motor vehicles (mostly vehicles of newer models) and a few in buildings in Serbia. Two case studies are presented in this paper: (A) one on a motor vehicle and (B) the other on the building. Within (A) case study, two modalities on vehicle and bus were described. In both cases, a fire occurred due to failures on electrical installations. For motor vehicles, after the analyzes, it was concluded that fires were mostly caused by pouring volatile flammable liquids, while in several vehicles primary short-circuit on electrical installations was the cause of the fire.

In the vehicle (Fig. 5), which is fired while driving only a few days after repair, the cause is false reparation that induced friction of electrical installations with car body creating thinner insulation and then arcing, or primary short circuit.

In the case of bus (Fig 6), which was in the parking, the fire originated "by itself". After sampling the electrical installation from suspicious sites in the engine compartment of buses (Fig. 7) and conducting forensic analysis, it was determined that the cause of the fire on the bus was short-circuit on power supply conductor of protective controller relay, which is linked to the flow pump. The emergence of further fire is ignition of electrical flow pump and the preheater and flammable materials (oil residues and traces of oil).



*Figure 5. The vehicle and the engine compartment after fire*



*Figure 6. Buses and engine compartment after fire*



*Figure 7. Excluded samples from the engine compartment of buses for laboratory analysis*

In case (B) of fire in/at facilities in Serbia, there were more cases of fire inside the building, caused by worn-out electrical installation and improper handling.

Building of the Workers' University of Novi Sad presents an example of fire at the facility (Fig. 8a and 8b). The building of the Workers' University of Novi Sad, as it was later concluded after conducting an analysis, was destroyed by fire emerged from worn-out and damaged electrical installation. In Figures 8a and 8b, spread of fire on this building is shown.



Figure 8a: Workers' University in flames



Figure 8b: The rapid spread of fire to other floors

After extinguishing the fire, the material was sampled from the ruins, from the sites the least exposed to the effects of heat. Results of the analysis were unambiguous: the cause of the fire was worn out and damaged electrical installation. Air pollution on that occasion was significant. During the fire accident, huge amount of emerging and toxic gases was generated and released in the atmosphere as well as toxic and emerging substances sorbed on the solid particles and by wet and dry deposition located on the soil and river Danube (Zoric et al, 2014).

## CONCLUSIONS

This paper presents a method for analyzing primary short circuit as the cause of the fire on electrical installations of motor vehicles and buildings. The experimental X-ray analysis in research activities was used. The described method of Debye-Scherrer has shortcomings in the reading the resulting film. Specifically, since the distance measured between the planes is obtained on the film and represents the angle of X-rays diffraction and therefore atomic interplanar distance, lack of method is in detecting the intensity of the line and thus the precision of distance measurements between them.

Based on the results of the diffractograms ie. the peak of Cu or  $\text{Cu}_2\text{O}$ , it could be used for prediction if the cause of fire is primary or secondary short-circuit for forensic analysis. During the processes of burning and combustion the emerging substances (gases, volatile chemical species and toxic substances) are generated and inputted in water courses and atmosphere. This fire accidents present uncontrolled sources of environmental contamination. This type of forensic analysis of fire on buildings and vehicles is rare and subtle.

## REFERENCES

- Artamonov, V.S. et al. (2007). Расследование пожаров, МЧС России Санкт-Петербургский университет Государственной противопожарной службы, Sankt-Petersburg.
- Blagojevic, M. (2013) Ekspertiza udesa – požari i eksplozije, Fakultet zaštite na radu, Niš.
- Center of Fire Statistics (2010). World Fire Statistics Report No17, International Association of Fire and Rescue Services, National Committees of Russia, Germany and USA.
- <https://www.pmf.ac.me/Download.php>
- Zorić, V.M., Sajfert, V., Armaković, S., Šetrajić, J.P., Dmitrašinović, S.S. (2014). Forensic analysis of micro traces of the events in urban areas, Proceedings of 4th Urbaneco Conference, 542-549.

## **PUBLIC HEALTH AND THE ECOLOGY OF URBAN AREAS**

V International Conference  
„ECOLOGY OF URBAN AREAS“ 2016

## HEALING GARDENS IN THE SCOPE OF PUBLIC HEALTH

Aysun TUNA<sup>1\*</sup>, Parisa GÖKER<sup>2</sup>

<sup>1</sup>Inonu University, Faculty of Fine Art and Design, Department of Landscape Architecture, Malatya, Turkey

<sup>2</sup>Ankara University, Agriculture Faculty, Department of Landscape Architecture, Ankara, Turkey  
aysuntuna17@gmail.com, p.aliasghari.au@gmail.com

### ABSTRACT

*It is well known that rapid urbanization and economic and social structure changes caused by rapid urbanization threaten human/public health with the augmentation of population movements in parallel to industrialization and economic development. As opposed to negative effects caused by rapid urbanization, the effects of greenery on human health are pointed out and “healing gardens” approaches are developed in the scope of the improvement function of greenery. Considering the examples of healing gardens in the world, it is seen that many examples are situated at hospital areas or in close approximation to treatment centers. In this research, the concept of “healing gardens” and its examples were scrutinized as alternative and functional greenery for cities which have different urban macroforms today and where economic and demographic movements are experienced intensely, and generation of suggestions was aimed.*

**Key Words:** *Healing Gardens, Public Health, Gardens.*

### INTRODUCTION

The root of the word garden is Persian and it means “small vineyard”. In general; it is also defined as a piece of land where herbaceous and woody ornamental plants with a visual characteristic, fruit trees, vegetables and healing herbs are cultivated; in addition, as a piece of land where beauty, greenery-filled and relaxing properties of the nature are regulated by human intervention. Large or small scale and introverted yards or gardens integrated with the environment have been locations reflecting living conditions and economic and cultural characteristics of societies in specific periods of history, and shaped based on the region’s characteristics. In this context, changes created by humans and diversity for garden arrangement have added many differences to the garden phenomenon sensually and stylistically.

Gardens have been a kind of refuge which saved people from their troubles originating from the ordinariness of their daily lives and where they can be together with the nature’s creatures for centuries. On the other hand, “heaven” is defined in holy-scriptures and religious teachings generally as a place and extremely attractive garden that will be awarded to people and where they will spend their second lives.

Considering the garden progress from the historical perspective, it is seen that climatic characteristics of the geographies of civilizations and their cultural structures have shaped the gardens. For example, despite the garden discernment of eastern civilizations reflect the same ecological and climatic characteristics of Egyptian garden-art the garden discernment of Mesopotamian civilizations differs. It is seen that place arrangement studies were conducted in the gardens arranged formally and symmetrically in Egypt and the gardens and greenery where more informal sensation similarity was desired by Assyrian and Babylonians. The gardens, arranged generally in quadrilateral areas until the Renaissance Period, gaining circular and curved lines over time based on romantic approach, and the modern gardens escaping from symmetry and elapsing to an informal order has been a progress not a change. Historical gardens, which are the examples that have reached today as a result of the historical progress of gardens that can be defined as an aesthetic shaping of the sociological environmental improvement, are a crucial part of historical landscaping of a country. Gardens project the details of life cognizance and desires, techniques, knowledge and culture of people who made them, ordered their construction and used them.

Considering in a general scope, the garden phenomenon, which is described as a land piece consisting of structural and plant components and enclosed by borders to cultivate flowers, trees, vegetables and fruits, is an open space construction shaped and improved by various cultures within different civilizations and geographies throughout the historical process (Erdoğan 2003).

### **History of Healing Garden**

History some of the earliest gardens that are noted for their restorative qualities can be traced back to Persian gardens. One of the first known Persian gardens was from the sixth century BC (Brookes 1987). Persian gardens incorporated lush green vegetation into a geometrically designed and ordered space. They offered “the outward and visible sign of an inward, invisible grace: the promise of divine order and meaning amid chaos, of ever-renewing life in the face of mortality, and of ease after travail” (Khansari et.al.1998). The garden elements combined to create a restful place where tensions were relieved and contemplation was encouraged. The contemplative gardens of the Far East, such as the Japanese Zen Garden, are another early example of restorative gardens. Gardens and religion are inseparable in Japan. The Japanese believe that natural elements in the garden are a manifestation of gods, and many were placed in religious institutions. These gardens are meant to provide guidance and consolation for the user. Becoming prominent in the twelfth century, Zen gardens in particular provided restorative qualities. Zen is about meditation and connecting oneself as part of the universe. This practice added an additional dimension to Japan’s gardens for meditation (Schaarschmidt and Richter, 1979). The Zen garden provided an opportunity for an individual to escape worldly afflictions and increase spirituality. Some of the first restorative gardens in the western world date back to the Middle Ages in Europe (Marcus and Barnes,1999). Hospitals that served orphans, the disabled, the insane, and other impoverished people began appearing near monasteries and churches within towns (Gerlach et.al 1998). Anytime wealth was obtained inside the city, walls were built as a means of security. All of these walls throughout the town provided hospitals with screening that created enclosed gardens and yards. These enclosed spaces offered residents shelter, sun, and shade (Anderson, 2011).

The seventeenth and eighteenth centuries brought about a return to incorporating outdoor spaces in hospital design. New discoveries and research into infections prompted hospital designs that focused on promoting access to fresh air, cross-ventilation, and hygiene (Marcus and Barnes 1999). Hospital sites during this time included ample grounds, had well-drained soils, and utilized the sun’s direction and wind flows for climate control (Gerlach et.al 1998). The hospital architecture incorporated a series of wards connected by a service corridor, like the teeth of a comb. Known as pavilion hospitals, the spaces between the wards formed small, garden areas (Marcus and Barnes, 1999). In 1729, as physicians established a hospital in Edinburgh, a two-acre site was selected on a hill. The hospital was designed in a U shape in order to catch the sun and air (Gerlach et.al. 1998). A 1770 book outlined appropriate hospital siting and garden design principles (Anderson, 2011).

Outer spaces were included in hospital design in the 17<sup>th</sup> and 18<sup>th</sup> centuries. Inventions and researches conducted on infection directed hospital designs to focus on clean air, cross-ventilation and hygiene (Marcus and Barnes 1999). Large fields and well-drained lands were included in hospital areas and the azimuth and wind direction were benefited for climate control during this period (Gerlach et.al 1998). A series of wards connected to the service hallway was added to hospital architecture. A hospital was erected on a hill in an approximately 8094 square meter area in Edinburgh in 1729. The hospital was designed in a U-shape to receive sun light and air (Gerlach et.al 1998). A book published in 1770 discussed the principles of appropriate hospital areas and garden design (Anderson, 2011).

During the last half of the nineteenth century, the value of nature as a method of healing was also apparent in the public parks movement. During this time the great industrial revolution blossomed, and as a result cities were flooded with new residents. Immigrants from Europe and other poor and impoverished people moved into crowded, dirty housing accommodations. Governmental agencies failed to provide adequate services and accommodations for the growing 15 population. As a result, harmful and often deadly conditions abounded (Fisher 1986). Sanitation provisions in the cities were



haphazard at best. The overcrowding and terrible conditions led many out onto the streets looking for relief. Unfortunately, most of the streets were in a similar state. Frederick Law Olmsted, a pioneer of landscape architecture in the United States, was concerned about the sad state of affairs in urban environments. Olmsted noted that the urban-dweller was often “overcome by physical exhaustion and psychological disorganization” due to the terrible conditions (Anderson, 2011).

The latter part of the nineteenth century continued to see nature and healthcare coexist. Continuing on early into the twentieth century, common nursing practice involved wheeling patient beds onto hospital balconies and roofs. Fresh air and sunlight was an integral part of treatment for tuberculosis at the time. In a photo taken at a San Francisco hospital, rows of patient beds are shown arranged on trellised roof gardens (Marcus and Barnes 1999). A 1918 book about hospital design referred at length to incorporating expansive grounds, courtyards, and park-like settings into facilities. One chapter was even titled “Landscape 16 Architecture as Applied to Hospitals”. The book explained the patients’ needs were to be considered over anything else: “It is true in landscape planning as in building planning that the patient must be considered, and the therapeutic and healing benefits of the sun’s direct rays must outweigh the architecture...” (Marcus and Barnes 1999). Unfortunately, such practices did not last. The twentieth century brought great advancements to many fields and disciplines. Transportation, communication, and information dissemination advancements led to a fastmoving environment. Progress became centered around profit and efficiency. Medical innovations led to cures for previously lethal diseases (Gerlach et.al 1998,). Advances in high-rise construction and elevators replaced the pavilion hospitals with multistory complexes (Marcus and Barnes 1999). Medical advancements in areas like pharmaceuticals, x-rays, and complex surgical procedures created demands for more specialized hospital spaces. This altered the internal and external environmental relationships that once were.

A return to nature in medical settings began to occur again in the 1990s. During the 1980s and 1990s, a considerable amount of research supported the position that views of, or access to, nature had positive effects on health outcomes. A couple of studies showed that the majority of respondents chose to go to natural settings when feeling upset or stressed. In one study, surveys were distributed to former hospital patients who had wide-ranging medical problems, were treated in different locations, and were of varied ages. Regarding the physical environment in the healthcare setting, the most commonly shared preference among these former patients was access to nature. This included gardens, views of nature, pictures of nature, and 18 balconies (Marcus, 2005). Another major study surveyed focus groups of patients and their families. The survey asked respondents to identify what they most desired from a healthcare environment. Researchers found that “closeness to nature” in the built environment was one of seven consistent desired elements in healthcare settings (Anderson, 2011).

The psychological and physiological favorable effects of spending time in green fields and gardens on people have been proven scientifically. Green fields, the nature, sun light and clean air has been described as the main components of health from the middle ages until the beginning of the 19<sup>th</sup> century. The effects of the nature on human health were assessed by various cultures and societies. Various methods including Zen and convent gardens were applied. However, technological progress in medicine since the beginning of the 20<sup>th</sup> century played an important role and traditional healing methods have left their place to technological methods. Designers featured green field and nature therapy studies again during the 1990s and started to develop green field-focused designs. During 1998-1999, the chamber of landscaping architects in America started to give seminars on healing gardens. Researchers investigated the effects of human and nature relationship on health during this period and introduced the healing garden concept. Healing gardens have crucial effects on human mind, body and mental health. Moreover, they strengthen the physical, sensory and social dimensions as well (Anderson, 2011).

There are two significant principles for the healing garden design; active and passive gardens. Gardens that have a direct interaction with the environment physically (planting flowers, cultivating plants, etc.) are defined as active. In the passive method, on the other hand, therapy and healing methods only

with eyesight, hearing and sensation are provided. Passive and active usages must be considered at the design stage to ensure optimum usage in healing gardens.

**Healing gardens are classified under four headings:**

- Meditation gardens
- Healing gardens
- Restorative gardens
- Enabling gardens

**Meditation gardens**

Meditation gardens consist of a small-scale, confined, quiet and calm area. These gardens are designed based on focus-point concentration and contribute to issues including strengthening of peace and concentration aspect and getting rid of stress caused by daily life during the healing process.

**Healing Gardens**

Healing gardens have been designed to remove people from stressful settings. Healing gardens, called therapy units as well, have been designed as a place for people to feel good physically, psychologically and physiologically, to improve their physical movements and motivations and to do their strolling, walking, relaxing and observation activities. These gardens get in contact with people by means of their five senses in a general sense and ensure the peace and healing concept.

**Restorative Gardens**

Restorative gardens are examples of a garden suggested for both healthy and sick people to spend time. These gardens encourage healthy individuals to be assertive in their social surrounding. They improve relief sensation of people and prepare them for personal thought or create the sensation of belonging to a community among people present in this garden. The design of restorative gardens has been developed based on the concept of behavioral and social sciences.

**Enabling gardens**

Enabling gardens provide an entertainment opportunity to people at any age based on their own power and limits. This garden type has been designed for the use of the elderly and disabled especially. Safety and usage convenience is the most important issue that needs to be considered in areas to be used by the elderly and disabled.

The effects caused by the characteristics of Meditation, Healing, Restorative and Enabling gardens discussed under four headings in the scope of healing gardens are as follows.

- **Meditation gardens;** simplicity, privacy, peace and mental health
- **Healing gardens;** getting in contact with five senses, mental health, legibility
- **Restorative gardens;** ensuring socialization opportunity and physical activity opportunity, peace, mental health
- **Enabling gardens;** active interaction with the nature, sense of safety in the setting

**Fundamental Properties of Healing Gardens**

There are ten key concepts involved for the healing and treatment effects of healing gardens. These are providing simplicity, privacy, peace, mental safety, sensual stimulation, legibility, and socialization opportunity, physical activity opportunity, and comfort and safety sense.

- **Simplicity**

The foundation of meditation garden is based on simplicity. These gardens must be designed not to cause a question mark or complexity in the minds of people who use them.

- **Privacy**

One of the most important characteristics of healing gardens especially meditation and restorative gardens is creation of privacy and private use areas. Designing private use areas and construction of green walking trails for ensuring a direct interaction with plants in restorative gardens must be considered.

- **Peace**

Creation of peace and tranquility sense in the scope of healing gardens is among the fundamental components of meditation, restorative and healing gardens especially. Peace created by these gardens affects the five sense organs (eyesight, hearing, sensation, smell, touching) and diminishes the stress rate in inner world and improves life quality of patients or healthy individuals who spend time in these gardens.

- **Perceptibility**

Perceptibility and convenient use is one of the issues that needs to be considered for the design of healing gardens since they consist of walking trails and activity or resting areas. It is crucial that the included area is perceptible and lacks covers to prevent this sight in the framework of the perspective of persons who use this area.

- **Allowing social activities**

According to the conducted scientific research; people who are engaged in social activities are healthier than people who are depressive or live alone because social activities and interaction with people have favorable effects during the treatment process of illnesses. Therefore, healing gardens and especially restorative and healing gardens must be designed to enable sitting areas for social activities and an opportunity for healthy or ill persons to spend time together.

- **Allowing physical activities**

Allowing physical activities is one of the crucial factors of restorative gardens. Restorative gardens must be designed in the form of sections on the center line by considering inclusion of walking areas and sections for physical activities, and the walking areas not to be too long.

- **A sense of safety**

The safety issue is important in healing gardens generally and especially reabling gardens since they will be in a direct activity interaction with the nature. An extreme sense of safety must be created for patients or healthy people who spend time in this area. The factors including falling, getting lost, hastiness or stress must minimized by the design criteria and sense of safety must be created.

## **CONCLUSION**

Socio-economic-ecologic transformations brought along with the city life affect social and personal health unfavorably. Enhancement of urban green fields has been aimed first to diminish unfavorable effects of structural environment on human health, and subsequently “healing” function of green fields has been emphasized and “health design” approaches have emerged. Healing gardens are a mediator for the city to approach the nature and function as open space therapy centers for persons to gain their health. Healing gardens differ based on planning and design principles and patient profile due to their

therapy function. At Samaritan Hospital in Portland, fields consisting of various elevations and different texture improving brain functions of patients who are treated for brain damage and enabling physical activities, and edges for sitting and bending and labeled spaces for color and shape-reading have been established, and design criteria have been adapted aiming prioritization of spatial perception that reminds Alzheimer patients their own home life and has a simple path system. On the other hand, at New York Cardinal Cook Hospital shaded spaces have been formed by using trees with tall leaves in place of structural components to protect HIV patients from sun light, and food service units must be situated in a close distance to the gardens in garden designs against the sensibility developed for strong odors due to intense medication during the chemotherapy process of cancer patients (Marcus and Barnes, 1999). Patient profile that is determined fundamentally, and necessities of health personnel and visitors must be considered when healing gardens are designed and the design must be directed.

Considering the evaluated examples, it is proposed that healing gardens designed at hospital gardens mostly can be utilized as an alternative method for urban green field designs with their psychological, social, physical, emotional and mental contributions in terms of their potential to diminish the effect of urban life on public health and to improve green field quality.

## REFERENCES

- Anderson, B.J., (2011). An Exploration of the Potential Benefits of Healing Gardens on Veterans with PTSD, The Graduate study of Utah State University the degree of Master Of Science of Landscape Architecture Thesis, Utah.
- Brookes, John. 1987. Gardens of Paradise. London: Weidenfeld and Nicolson.
- Cooper Marcus, C. and Francis, C. (ed.) 1998. People Places: Design Guidelines for Urban Open Space (2nd ed.). New York: Van Nostrand Reinhold
- Cooper Marcus, C. and Barnes, M. (ed.) 1999. Healing Gardens: Therapeutic Benefits and Design Recommendations. New York: Wiley and Sons
- Erdoğan E. Yazgan M. Köylü P. 2003. Turkish Gardens. Ankara University Research Project. Ankara.
- Fisher, Irving D. 1986. Frederick Law Olmsted and the City Planning Movement in the United States. Ann Arbor, Michigan: UMI Research Press.
- Gerlach - Spriggs, N., Kaufman, R.E., Warner, S.B. 1998. Restorative gardens: The healing landscape. New Haven, CT: Yale University Press.
- Khansari, Medi, M. Reza Moghtader, and Minouch Yavari. 1998. The Persian Garden: Echoes of Paradise. Washington, DC: Mage Publishers.
- Schaarschmidt-Richter, Irmtraud. 1979. Japanese Gardens. New York: William Morrow and Company, Inc.

V International Conference  
„ECOLOGY OF URBAN AREAS“ 2016

**RAISING AWARENESS ABOUT LINKAGE BETWEEN  
ENVIRONMENTAL CONTAMINATION RISK AND PROVIDING  
FOOD SECURITY TO POPULATION IN THE REPUBLIC OF SERBIA**

**Vesela Radović<sup>1\*</sup>, Bogdana Vujić<sup>2</sup>, Ekaterina Arabska<sup>3</sup>**

<sup>1</sup>Institute for Multidisciplinary Research, Belgrade University, Serbia

<sup>2</sup>Technical faculty “Mihajlo Pupin”, Serbia

<sup>3</sup>University of agribusiness and rural development – Plovdiv, Bulgaria  
veselaradovic@yahoo.com, bogdana.vujic@tfzr.rs, katya.arabska@gmail.com

**ABSTRACT**

*The paper examines the issues of food security and food insecurity in the context of the strategic priorities of sustainable development, putting a special focus on ecological development pillar, and air, water and soil pollution in particular. Environmental contaminations risks are analyzed in their link to food security through the example of the Republic of Serbia considering that food is among the most important factors determining human well-being. On the basis of historical, comparative and data analyses the study makes important conclusions and recommendations concerning the activities of policy makers and academic institutions in the area of environmental protection and food security. The significance of effective and adequate responses, a good coordination between responsible institutions and actions on raising awareness is underlined in the discussions on the threats and the opportunities for rural sustainable development taking into account agriculture as being on the basis of food security and as a subject of environmental contamination risks.*

**Key words:** food, security, agriculture, environment, sustainability.

**INTRODUCTION**

Sustainability as well as sustainable development in global world became two of the most used terms. Hence, despite all efforts it does not mean that the sustainability revolution is already fully formed and well established. Far from it: enormous obstacles and barriers remain (Kiernan, 2009). Global community faces enormous environmental pollution, economic and political crises which generate unexpected risks. Numerous strategies and goals which aimed to improve the life of Earth populations are partially achieved. One of the examples could be useful for explanation of this statement. The sustainable development agenda evolving from the World Summit on Sustainable Development (WSSD) in 2002 in Johannesburg focused on pollution prevention (P2) because it is a multi-media (air, water and land) approach that reduces a facility or community's overall impact to environment. P2 is the key to all issues of sustainable development/economic, environmental and social. In 21<sup>st</sup> century global community is faces with numerous environmental and social issues.

In 2009 the UK Government's Chief Scientific Advisor, Professor Sir Jon Bedington, raised the prospect of a “Perfect Storm” of global dimensions by 2030 with the impacts of global challenges such as climate change, food, and energy and water security coming together to impact significantly the lives of all people on earth. According to the prediction the world's population is expected to increase from six to eight billion by 2030 and we can expect demand for food to increase by 50% (Bedington, 2009). Green Cross in one of their reports reveals that about 125 million people are at risk from toxic pollution across 49 low to middle-income countries (Green Cross, 2012). United Nations Environment Programme (UNEP) highlighted air pollution as a world's worst environmental health risk and insist on action to reduce level of air pollution (UNEP, 2014). Permanent trend of increase agricultural pollution lead that food security in many countries means that their food security start to rely on food imports. In China, about 3.33 million hectares (8 million acres) of farmland is too polluted to grow crops after three decades of rapid industrial growth. The area of China's contaminated land is about

the same size as Belgium. Wang Shiyuan, the vice-minister of land and resources said no more planting would be allowed on it as the government was determined to prevent toxic metals entering the food chain (Wang, 2014).

Into the new Sustainable development agenda of 17 goals adopted on September 25, 2015 priorities are set to “end poverty, protect the planet, and ensure prosperity for all” through specific targets for each goal to be achieved over the next 15 years. “Transforming our world: the 2030 Agenda for Sustainable Development” is a plan of action for “people, planet and prosperity”. The agenda once again underlines the importance of the ecological dimension of sustainability and assurance of food security (Fig. 1).



Figure 1. UN Sustainable development goals – the 2030 Agenda for sustainable development

Food is one of the most important factors determining the human well-being and development. The global financial crises of the last decade implicate economic stability, and as a consequence food security, taking into account that the global food system is very vulnerable. The 2013 World Economic Forum Report stated that global food and nutrition security is a major global concern in an era of increased volatility and uncertainty. Thus, measures to “improve food security are urgently needed” (World Economic Forum, 2013). Especially, in emergencies, food is essential for the survival and maintenance of the population’s health in affected areas. Therefore, the determinants of food insecurity in any circumstances and the capacity of the state to cope with unwished effects is of paramount importance for every country.

In numerous disasters chemical contamination posed environmental hazards for population in affected territory. The serious issue of chemical contamination rose after Hurricanes Katrina and Rita in 2005, The British Petroleum (BP) Deepwater Horizon disaster in the Gulf of Mexico in 2010, in Fukushima nuclear disaster in 2011 and many other. The tsunami caused extensive damage to agricultural land and facilities in Aomori, Iwate, Miyagi, Fukushima, Ibaraki, and Chiba prefectures, where hogs and dairy and beef cattle are raised alongside crops that include rice and a variety of vegetables (Bird and Grossman, 2011). The widespread devastation from the March 11, 2011, earthquake and tsunami affected many fishery areas in Japan. In addition, detected radioactive contamination of food produced near the disabled Fukushima Daiichi Nuclear Plant has raised fears about the safety of Japan’s food production systems and its future food exports (Johnson, 2011). In Serbia after the catastrophic flood in 2014 were recorded few cases of chemical contamination in abandoned chemical industrial facilities.

The issue of inadequate response to secure basic needs in emergencies (for vulnerable populations) occurred in Serbia and Bosnia and Herzegovina (B&H), as well in other countries of the West Balkan region. Despite the involvement of international organizations in the improvement of state services to promote food security, there is still lot of room for improvement. This reality is evidenced in numerous reports, and also in practice during emergencies of the last decade, such as the flood in 2014

which hit one third of the territory of Serbia, a significant part of Croatia, and B&H. The flood caused enormous suffering to the population and distorted normalcy of life for months after. Emergency services were accused for inadequate response because of food insufficiency in affected territory and delay in supplying. The flood event surfaced a series of logistical problems in storage and distribution of food commodity reserves, and made evident that without foreign food aid all struck countries would not have been able to endure the emergency.

Associations between environmental contamination and food security are, however complex and not so well characterized in Serbia. That initiated authors of this paper to tackle this paramount issue. One of the main questions that this paper envisions to answer is: “What are the Serbian government’s plans and capacities to deal with environmental contamination risks caused by natural or manmade impact, and how its food security policy can be coordinated with adopted programmes and policies?”. Current paper presents the issue in the following way. The introductory chapter is devoted to the presentation of the linkage among environmental pollution and food security. The second chapter discusses how Serbia has to move forward regarding the adequate level of environmental protection. Therefore, policy makers have to be more proactive in creation of the measures needed to protect environmental components (air, soil, water). Next chapter highlights the food security as unavoidable part of policy maker’s actions to create future sustainable country development. The last two parts are related to conclusion remarks and references used in the process of paper preparation in the main chapters of the paper. There is also a discussion about the future plan which would improve food security in Serbia as part of the national security strategy.

The methodology used in this article is standard for social researchers: historical analysis, comparative analysis and data analysis. It allows authors to use various documents from electronic databases, books, scientific journals, official documents and positive practice from developed countries. After a careful analysis of the data, all facts confirm that the activities of policy makers in the area of environmental protection and food security are rare and insufficient, but some recent events are pretty encouraging. Having in mind all the presented facts, it is clear that policy makers in Serbia have to be more engaged in the actions useful to food security.

## **ENVIRONMENTAL STATE IN SERBIA: WHERE ARE WE AFTER ALL?**

Serbian environment is jeopardizing with numerous impacts, and its state could not be evaluated as satisfied. Regarding food production it is necessary to state that Serbian agriculture is declared as a priority development chance. Despite all measures of policy makers Serbian agriculture is in risks which are caused by many hazards (Radovic at al., 2012). Following the issue linked with food security it is important to briefly explain the state of all three environmental media (air, soil and water). In the Republic of Serbia considerable progress in the context of combating climate change and environmental protection was brought about by the beginning of the process of European Union (EU) accession and the harmonization of national legislation with that of the EU (Radovic, 2012).

The Ministry of Agriculture and Environment is obliged by law to lead and control environmental protection measures. The Serbian Environmental Protection Agency (SEPA) is in charge to control the environmental state, and regarding to that task - monitor the air quality management (Law on Air Protection, 2013; Law on Ministries, 2013). In its work SEPA follows specific national legal framework and includes data from automatic air quality monitoring within the local network of the city of Belgrade, the city of Pancevo and AP Vojvodina. In Serbia monitoring of air quality is conducted in three zones and eight agglomerations. In the period 2012-2013 SEPA was faced with numerous difficulties caused with budget shortfalls which enable servicing of the equipment and maintenance in general the national network.

In the last two decades despite an increasing public awareness to the importance of environmental protection and adoption of legislative framework similar to EU, Serbia lag behind in implementation of measures aiming to mitigate effects of air pollution. The research about “black hot spot” increased awareness of stakeholders in significant scope and some positive actions have been conducted. In the

area of the municipality of Obrenovac agriculture producers couldn't sell their products at Belgrade markets because of customers fear that the products are contaminated from the thermal power plant Nikola Tesla, facilities TENT A and TENT B. Both ash wasteland was settled near the five villages and caused air and water pollution. Total GHG emissions from EPS thermal power plants were 23.25 million tones of CO<sub>2</sub> in 2014. TENT A emitting 9.0 million tones, TENT B emitting 8.1 tones (Electric Power of Serbia - EPS, 2014). In last few years situation is improved, even it is still far from favorable. The Public Company Serbian Electro Power Industry invested in TENT A 37 million of Euros for specific electro filter, and 28 million of Euros to improve ash handling system. Hence, ash disposal decreased from 24 000 tons yearly on 4 000 tons per year.

The most visible obstacles in the area of air pollution are: lack of financial means, and some kind of misunderstandings between different actors in the area of environmental policy implementation, such as determination of pollution by particular matter that depends on the level of technology development. Air pollution in Serbia caused unacceptable environmental, social and economic costs. Sources of air pollution in Serbia include traffic, industrial sectors, and power plants, cooking and heating with solid fuels, forest fires and open burning of municipal waste and agricultural residues.

On December 18, 2013, the European Commission adopted a Clean Air Policy Package with the aim to further reduce the impacts of harmful emissions from industry, traffic, energy plants and agriculture on human health and the environment (European Commission, 2013). The package included a new Clean Air Programme for Europe with measures which are to ensure that existing targets are met in the short term, and new air quality objectives for the period up to 2030. Preventing soil contamination which being increasingly degraded across the world, as well as in the Republic of Serbia, is also equally important for providing food security. The current state in Serbia could be recognized by numerous similarities with those in Europe regarding the soil pollution. The most important adopted documents are the Soil Thematic Strategy (European Commission, 2006) and a proposal for a Soil Framework Directive (European Commission, 2006). Serbia does not have adequate administrative capacities for the enforcement of existing laws and by-laws in the area of soil protection. The Government of the Republic of Serbia adopted a Regulation on the program for the systematic monitoring of soil quality, soil degradation risk assessment indicators and methodology for the development of remediation programs (Serbian Parliament, 2010). The adoption of this Regulation had an aim to ensure the soil protection based on prevention of degradation through identification of risk area for soil degradation. The national soil monitoring network is established to monitor soil quality in the Republic of Serbia on sites which are of special interest for the Republic of Serbia, where soil contamination has occurred or is likely to occur. The local soil monitoring network is established to monitor soil quality at the level of the Autonomous Province of Vojvodina and local government. The National List of Indicators represents a set of soil indicators used for systematization of the information about soil condition, land use changes, and factors of soil degradation.

Fertilizers, pesticides, heavy metals, feed additives and other agricultural chemicals used at farm sites could also pose potential contamination hazards to soil and surface and groundwater. In Serbia public perceptions and political considerations still play a key role in the decision-making process in relation to soil remediation. The need for soil remediation depends primarily on the nature of the contaminant and the land use. Some efforts are planned and done in a certain scope, like monitoring of soil quality, monitoring soil degradation risk assessment indicators and implementing programs for the remediation of the consequences of soil contamination and degradation, whether natural or human-induced but there can be much more improvement (Radovic and Rakic, 2013).

The implementation of remediation activities is so far from objectives, and it is evaluated as insufficient in numerous official reports and scientific research works; due to many objective and subjective reasons. The incident which happened at the "Stolice" mine tailing in Kostajnik (Krupanj) is one of the main stand-alone environmental problems caused by an extreme weather event and flood. Over 100,000 m<sup>3</sup> of tailing slurry was consequently released into the Kostajnik stream, a seasonal tributary of the Jadar River. Downstream of the mine tailing, the flash floods covered a land area of between 50-75 meters wide with a sediment deposit ranging 5-10 cm. Soil analysis showed the



sediments to contain extremely high levels of arsenic, antimony, barium, zinc and lead requiring urgent remedial intervention. Mine disposal sites were also flooded and the waste material was discharged into rivers that were used as sources for drinking water supply. The Joint United Nations Environment Programme (UNEP)/Office for the Coordination of Humanitarian Affairs (OCHA) Environment Unit (JEU) helped Serbia to mitigate the consequences of this environmental disaster in the Stolice mine near the town of Krupanj. In the report UNEP estimated that total value of the environmental damage is \$27.9 million in Serbia, and recommended an environmental plan estimated at \$56.2 million (UNEP, 2014). In Serbia there are 20% of total land areas which are recognized as officially contaminated sites. All of those sites contain one or more pollutants. Industry which contributes to the soil pollution is on the first place: petrochemical industry, the chemical industry and industry of metal production (Serbian Ministry of environmental protection and urban planning, 2009). Multimedia P2 approaches work to solve environmental problems holistically and do not only focus on pollution in a single medium. Many times contamination can result in the transfer of contaminant from one media to another. The water pollution is sometime caused with that specific transfer. As Serbia have only 8% of domestic water, since 92% of water are transboundary, water environmental impacts from other country is recognized as a great threat. In numerous cases river were contaminated and Serbia faced dangerous consequences - for example from ecological disasters in Baia Mare gold mine in Romania in 2000, and “red mud” in Ajka, Hungary, in 2010. The shortage of purification capacity for urban water is also important issue for future mitigation of water pollution in Serbia as well insufficient implementation of the general waste removal strategy. There are great numbers of waste land where leaching water contaminated nearby river and almost there is not completely adequate sanitary waste land in the country. Because of limited irrigation capacity agricultural producers sometimes use polluted water for irrigation from channel and increase microbiological contamination of their products (mostly vegetables). Serbia as a candidate country should follow the proposed action, but due to all counted above the design of effective abatement strategies for reduction environmental pollution becomes very difficult if we take into count the socio economical problems (Bang Quoc, 2012; Serbian Parliament, 2011).

## **FOOD SECURITY AS AN IMPORTANT TASK FOR POLICY MAKERS**

Many organizations are involved in the area of providing food security since the World Food Conference in 1974 defined food security in terms of food supply - assuring availability and price stability of basic foodstuffs at the international and national level. The safe food is a precondition for the protection and promotion of health. Despite all efforts the successful health protection in the modern world of risks sometimes is not as it was expected. In the global community there are numerous facts which witnessed about new food safety challenges. Many studies now analyze “food insecurity” as a social and political issue, in which the ethical and human rights dimension has come into the focus.

The Food and Agriculture Organization of the United Nations FAO presented the following definition of food security: “Food security exists when all people, at all times, have physical and economic access to sufficient, safe and nutritious food that meets their dietary needs and food preferences for an active and healthy life” (Kennan and Hammond, 2013). From other point, Food Safety System in the Republic of Serbia includes the Ministry of Agriculture, Forestry and Water Management and the Ministry of Health (MH). Ministry of Internal and External Trade and Telecommunication (MoTT) is responsible for the implementation of the Law on Standardization, and the Market Inspection department is responsible for inspecting food quality at the retail level. There is also a significant number of academic institutions and departments at universities which undertake research contributing to the area of food safety.

Seeking and analyzing carefully documents and action linked with the Serbian government’s plans and capacities to deal with environmental contamination risk caused by natural or manmade impact, and how its food security policy can be coordinated with adopted programmes and policies, current study concludes that in the future more efficient response could be implemented. During the catastrophic floods in 2014 many actions were performed ad hoc and were unplanned and did not perform on an

appropriate way. The vulnerability of the system of food security was obvious in daily action. In Serbia 7.4 million inhabitants reside in rural areas and identify agricultural activity as sources of income. Agriculture is considered to be the biggest employer in rural areas and the main contributor to the rural population food security.

Because of potential contamination, agricultural area in flood are tested by the Ministry of Agriculture and Environmental Protection in order to ensure that vegetables and food crops would not be contaminated with heavy metals and other kind of contaminants. In some localities (e.g. Cacak, Kraljevo, Smederevo Palanka, Jagodina) concentrations of nickel, lead and chromium were found at certain sites to be above the maximum permitted level. Other sites such as in Kosjerić and Loznica were found to have high levels of lead and arsenic. Restrictions were therefore imposed on the types of crops that could be grown, and special measures such as ploughing are required to reduce contamination levels. Finally, lime was also observed to have been applied to help disinfect agricultural land suspected to have been contaminated with sewage. Government soil analyses showed that heavy metal levels were generally below maximum permitted values for agricultural land and, thus, crops can be considered safe. There is concern in some areas that leafy crops, like lettuce, chard and brassicas, may be contaminated. This underlines the need to remove sludge debris (Serbian Government, 2014).

Customers generally show mistrust of food stuff grown in polluted areas because they fear contamination. Following expert advises some agricultural area after floods in 2014 were replant, but generally agricultural produce was heavily impacted. Raw milk collection for example was disrupted in Obrenovac for one month, since in other municipalities that disruption lasted about five days. Environmental impacts in every disaster are significant and effects on production flow.

Despite numerous international actions and actions of civil sectors, academic community did not create any program to educate farmers on environmental security best practice. Current financial constrains thwarted creation and execution of training program in society, so as in agricultural community. It looks like there are no sufficient actions to prevent plants contamination (vegetables, crops or trees). Since plants become contaminated with the pollutants from the environment based on the ability of plant to extract environmental pollutants along with water and nutrients through their roots, there is logic need to prevent the pollution in general.

The reactions of competent authority in those events are a clear example of an inadequate risk communication. In Serbian societies the risk awareness is far from favorable. In last two years in Serbia were recorded numerous events where state stakeholders stayed “silence for a while”: in environmental emergency in Kostajnik, in food outbreak in Smederevo, food outbreak in six elementary Belgrade’s schools and so on. The urgent action in the area of the appropriate risk communication during the emergency and established coordination between all stakeholders has to be an urgent future task for policy-makers. The only way to build the trust between population and policy makers is by delivering accurate and timely information, even if it might be scary (Radovic at al., 2014). Since 2000 change in policy Serbia tried to bring environmental pollution under control and established pretty effective monitoring system in the area of pollution, but some innovative actions are still missed due to subjective and objective reasons.

## **CONCLUSION**

Every responsible state has to provide citizens the right to food security throughout their life. The main determinant of food insecurity is the vulnerability of people, which in turns is induced by poverty. The gap between demand and supply of food increases and, in many towns in Serbia public kitchen, started to be the only way for some people to fulfill their basic need. Keeping in mind that Serbian population is among the poorest nation in Europe, food security has to be in the forefront of policy makers. The plans and policies needed to achieve this task have to apply a holistic approach. As a result of the recent food crises many governments have turned their attention to food policy and support of rural sector. Environmental contamination is a major threat for environment and a significant limitation to the likely success of feeding populations. The cost of food is rising

continuously and it is expected that food insecurity will increase, especially in any kind of emergency. Therefore the best way to look at food security is through reduction of food insecurity in two possible ways: enhancing agricultural productivity and increasing access to food for individuals. The policy makers should finally act to decrease the variety of reasons for food insecurity ranging from effects of industrial pollution, global climate change (weather extremes) to economic and political issue, all of which poses risk of potential food insecurity to populations. Food security should be considered as part of the national security and properly treated in relevant strategic documents.

## ACKNOWLEDGMENT

This paper is produced as a part of ongoing Project named: ‘Modulation of Antioxidative Metabolism in Plants for Improvement of Plant Abiotic Stress Tolerance and Identification of New Biomarkers for Application in Remediation and Monitoring of Degraded Biotopes’, coded III 43010, financed by the Serbian Ministry of Science and Education, and technological development.

## REFERENCES

- Bang Quoc, Ho. (2012). Urban Air Pollution. In Khare M. (Ed.) *Air Pollution Monitoring Modeling and Health*, InTech, USA.
- Bedington, J. (2009). *Food, energy, water and the climate: A perfect Storm of Global Events?* Available at: [www.bis.gov.uk/assets/geoscience/docs/p/perfect-storm=paper.pdf](http://www.bis.gov.uk/assets/geoscience/docs/p/perfect-storm=paper.pdf). Assessed on September 01, 2016.
- Bird, W., Grossman, E. (2011). *Environmental Health Perspective* v.119 (7), 290-301.
- Electric Power of Serbia – EPS. (2014). *Yearly report*. [www.eps.rs](http://www.eps.rs).
- European commission EC (2013) *Impact Assessment accompanying the documents Communication from the Commission to the Council, the European Parliament, the European Economic and Social Committee and the Committee of the Regions-a Clean Air Programme for Europe*. European Commission (EC), Brussels, Belgium.
- Green Cross. (2012). *World's Worst Pollution Problems*. Switzerland.
- Johnson, R. (2011). Japans Earthquake and Tsunami: Food and Agricultural Implications. Washington DC. Congressional Research Service. Available at: <http://tinyurl.com/3yde5d4>. Assessed on September 02, 2016.
- Keenan, S, Hammond, J. Food Safety Situation in Serbia. Brussels, Belgium: European Parliament Directorate-General for Internal policies Policy Department: A: Economic and Scientific policy IP/A/ENVI/INT/2013-16&17 PE507.487. 2013. Available at: [http://www.europarl.europa.eu/RegData/etudes/note/join/2013/507487/IPOL-ENVI\\_NT\(2013\)507487\\_EN.pdf](http://www.europarl.europa.eu/RegData/etudes/note/join/2013/507487/IPOL-ENVI_NT(2013)507487_EN.pdf), Accessed on 05.01.2014.
- Kiernan, M.J. (2009). *Investing in a sustainable world: why the green is the new color of money on Wall Street*. AMACOM – American Management Association, New York.
- Law on Air Protection. (2013). *Official Gazette of the Republic of Serbia*, No. 36/09, 10/13.
- Law on Ministries (2013). *Official Gazette of the Republic of Serbia*, No. 72/12, 76/13.
- Progress in the management of Contaminated Sites in Europe, Institute for Environment and Sustainability, Joint Research Centre reference report, European Commission, 2014. <http://publications.jrc.ec.europa.eu/repository/bitstream/111111111/30755/1/lbna26376enn.pdf>
- Proposal for a Directive of the European Parliament and of the Council establishing a framework for the protection of soil and amending Directive 2004/35/EC/\* COM/2006/0232 final - COD 2006/0086\*/. (2006). Available on: <http://eurlex.europa.eu/LexUriServ/LexUriServ.do?uri=CELEX:52006PC0232:EN:NOT>
- Radović, V. (2012). Climate Change and Adoption Strategies: A Report from the Republic of Serbia. In: *National Security and Human Health Implications of Climate Change*. Ed, HSJ Fernando, ZB Klaic, JL McCully. Springer Publishing, NATO Science for Peace and Security: Series C Environmental Security, Dordrecht, Netherlands, pp. 95-102.
- Radović, V., Čurčić, Lj, Stepanov, J., Prokić, D. (2012). Increasing awareness about need of preparedness and response of agricultural household and enterprises in floods in Vojvodina, *Proceedings of the International Conference NewEnviro: New Approaches for Assessment and Improvement of Environmental Status in Balkan Region – Interactions between organisms and environment*, 28-30 May 2012, University of Educons, Sremska Kamenica, 84-89.
- Radović, V., Keković, Z., Agić, S.(2014). Development a Comprehensive Food Safety System in Serbia - A Narrative Review Article, *Iranian Journal of Public Health*, 43 (7): 889-902, 2014.

- Radović, V., Rakić, S. (2013). The management of contaminated sites and soil remediation in Serbia. *Scientific Proceedings XXI International Scientific and Professional Meeting "Ecological Truth"* Eco-Ist '13 (4-7 June, 2013, Bor Lake, Hotel "Jezero", Bor, Serbia). University of Belgrade, Technical Faculty in Bor, Republic of Serbia.
- Regulation of the program for the systematic monitoring of soil quality, soil degradation risk assessment indicators and methodology for the development of remediation programs. *Official Gazette of the Republic of Serbia*, No. 88/10.
- Serbian Government, World Bank, United Nation Development Programme (UNDP). Serbia Floods. (2014). *Serbia Floods*, Retrieved February 24, 2016, from [http://ec.europa.eu/enlargement/pdf/press\\_corner/floods/20140715-serbia-rna-report.pdf](http://ec.europa.eu/enlargement/pdf/press_corner/floods/20140715-serbia-rna-report.pdf)
- Strategija o aproksimaciji potreba National Environmental Approximation Strategy for the Republic of Serbia. (2011). *Official Gazette of the Republic of Serbia*, No. 80/2011.
- Sustainable development goals. Available at: <http://www.un.org/sustainabledevelopment/sustainable-development-goals/>.
- The European Commission's Soil Thematic Strategy (COM (2006) 231). Available at: [http://ec.europa.eu/environment/soil/three\\_en.htm](http://ec.europa.eu/environment/soil/three_en.htm).
- The Serbian Ministry of environmental protection and urban planning.(2009). *The Report of soil state*, page 33, Belgrade.
- Transforming our world: the 2030 Agenda for Sustainable Development. Resolution adopted by the General Assembly of the UN on 25 September 2015.
- United Nation Environmental Programme UNEP 2014. Disaster and conflicts, Minimizing Environmental threat. Retrieved March 1st, 2016 from <http://www.unep.org/annualreport/2014/en/disaster-conflict.html>.
- United Nation Environmental Programme UNEP. Disaster Year Book Air Pollution: World's Worst Environmental Health Risk, 2014.
- Wang, Y. (2014). *Polluted farmland leads to Chinese Food Security fears*. Available at: <https://www.chinadialogue.net/article/show/single/en/6636-Polluted-farmland-leads-to-Chinese-food-security-fears>. Assessed on September 01, 2016.
- World Economic Forum. (2013). *Achieving the New Vision for Agriculture: New Models for Action*. Geneva, Switzerland.
- World Food Conference, 1974. Available at: <http://www.un.org/en/development/devagenda/food.shtml>. Accessed on September 04, 2016.
- World Summit on Sustainable Development 2002. Available at: <http://www.un.org/events/wssd/>. Accessed on September 04, 2016.

V International Conference  
„ECOLOGY OF URBAN AREAS“ 2016

## EQUILIBRIUM STUDY FOR THE PROCESS OF REMOVAL OF NI(II) IONS FROM AQUEOUS SOLUTIONS BY NATURAL BENTONITE

Katerina Atkovska<sup>1\*</sup>, Hamdije Memedi<sup>2</sup>, Kiril Lisichkov<sup>1</sup>, Gordana Ruseska<sup>1</sup>, Stefan Kuvendziev<sup>1</sup>, Mirko Marinkovski<sup>1</sup>, Anita Grozdanov<sup>1</sup>

<sup>1</sup> Faculty of Technology and Metallurgy, University “Ss. Cyril and Methodius”,  
Rugjer Boskovic 16, Skopje, Macedonia

<sup>2</sup> Faculty of Natural Sciences and Mathematics, State University of Tetovo,  
str. Ilindenn.n., 1200 Tetovo, Macedonia  
klisickov@yahoo.com

### ABSTRACT

*The increase of industrial activities has intensified environmental pollution problems and the deterioration of eco-systems with accumulation of many pollutants, especially heavy metals. Effluents containing heavy metal ions are considered as the serious threat for environmental pollution and thus the public health. Therefore, the elimination and reduction of heavy metal ions from water resources is very important from the ecological, evolutionary, nutritional and environmental reasons. In the frame of this work, the natural bentonite was applied as a potential, low - cost raw material, for removal of Ni(II) ions from aqueous solutions. The experimental results were obtained in a laboratory scale batch glass reactor (working volume 2l) with continuous stirring at 400 rpm. The equilibrium process was investigated at the following operating conditions: initial concentration of Ni(II) ions of 0.3, 0.4 and 0.5 mg/l, mass of the adsorbent 2.5 g/l, initial pH value 6-7 and adsorption time from 1 – 180 min. The obtained equilibrium data were studied using Langmuir and Freundlich isotherm models. The common techniques were utilized to characterize the investigated natural material.*

**Key words:** heavy metals, Ni(II), natural bentonite, equilibrium study, adsorption.

### INTRODUCTION

The rapid industrial development and unplanned urbanization have intensified environmental pollution and caused deterioration of eco-systems by accumulation of many pollutants, especially heavy metals. Heavy metal ions are not biodegradable and persistent and their toxicity is a problem of increasing significance for ecological and environmental reasons (Nagajyoti et al., 2010). The water pollution by heavy metals causes a lot of disease problems such as renal kidney disease, nervous system damages, cancer, mental retardation (Mubarak et al., 2014). Therefore, the removal of heavy metals from water and wastewater is very important for environmental protection and thus the public health.

There are different techniques used for heavy metal elimination from water and wastewater, such as chemical precipitation, ion exchange, solvent extraction, electrolysis, membrane processes, adsorption (Fu and Wang 2011, Vindoh et al., 2011, Bakalar et al., 2009, Rahul, 2013, Lokendra and Mukesh 2013). Adsorption is most effective, efficient and economic method for wastewater purification and it is widely used in effluent treatment processes. Various materials such as clay minerals (Ghormi et al., 2013, Liu and Zhou 2010), activated carbon (Kouakou et al., 2013, Bernard and Jimoh 2013), natural and synthetic zeolites (Shaban et al., 2016, Shaheen et al., 2012), bisorbents (Sarifah et al., 2015, Kyzas, 2012), have been applied as adsorbents for heavy metals elimination from water and wastewater.

Clays have typical properties (large surface area, high cation exchange capacity, layered structure and low cost) that predispose them to be good adsorbents. Bentonite belongs to the group of clay minerals. The main constituent of bentonite is montmorillonite, composed of units made up of two silica tetrahedral sheets with a central alumina octahedral sheet. A number of studies have been reported using bentonite, and have shown its effectiveness for the removal of heavy metal ions, such as Ni(II)

ions, from aqueous solutions (Ghormi et al., 2013, Liu and Zhou 2010, Al-Shahrani 2012, Al-Dwairi et al., 2012).

## MATERIALS AND METHODS

### Bentonite source

The natural bentonite used as adsorbent for Ni(II) ions removal from aqueous solutions, originate from the north-eastern part of the Republic of Macedonia, near the city of Kriva Palanka (Ginovci district).

### Adsorption experiment

Adsorption studies were carried out using the batch adsorption technique to obtain equilibrium data. Standard solution of  $\text{Ni}(\text{NO}_3)_2$  with concentration of 1000 mg/l was used to prepare solutions with desired initial concentrations of Ni(II) ions of 0.3, 0.4 and 0.5 mg/l. These solutions were placed in 2000 ml beakers and 5g of dry natural bentonite were added into each beaker. The mixture of adsorbent and Ni(II) solutions was stirred using magnetic stirrer at 400 rpm, at pH of the solutions 6-7, at room temperature, for 3h, sufficient time to reach equilibrium. The samples were taken at particular time (5, 10, 20, 30, 60, 90, 120 and 180 minutes), filtered and the remaining concentrations of Ni(II) ions in the filtrate were determined using atomic absorption spectrophotometer, AAS Perkin Elmer model AA700. Experimental data were processed by the two most commonly used isotherms, Langmuir and Freundlich adsorption isotherm.

## RESULTS AND DISCUSSION

Characterization of the natural bentonite was previously conducted (Blagica et al., 2014). As it was reported natural bentonite has the specific surface area of 219  $\text{m}^2/\text{g}$ . XRD analysis of the bentonite verified that montmorillonite is the prevailing component. The appearance of characteristic bands at FTIR spectrum of bentonite, revealed the presence of amorphous  $\text{SiO}_2$ , Al-O-Si-O bond, adsorbed water and OH groups which presence was additionally confirmed by TGA-DTA analysis. The results of granulometric sieve analysis showed that the fraction of particles size below 0.032 mm corresponds to 88 mass %. The conventional silicate chemical analysis affirmed that natural bentonite contains 61 mass % of  $\text{SiO}_2$  and 21 mass % of  $\text{Al}_2\text{O}_3$ .

### Adsorption studies

The adsorption experiment was conducted at room temperature, pH of the solution 6-7 with an amount of natural bentonite 2.5 g/l, different initial Ni(II) ions concentrations of 0.3, 0.4 and 0.5 mg/l, volume of the solution 2l and at 400 rpm of magnetic stirring. The reduction of the concentration of the Ni(II) ions over time at various initial metal concentrations is given at Figure 1. It can be seen that the adsorption equilibriums were achieved after 50 min. of magnetic stirring.

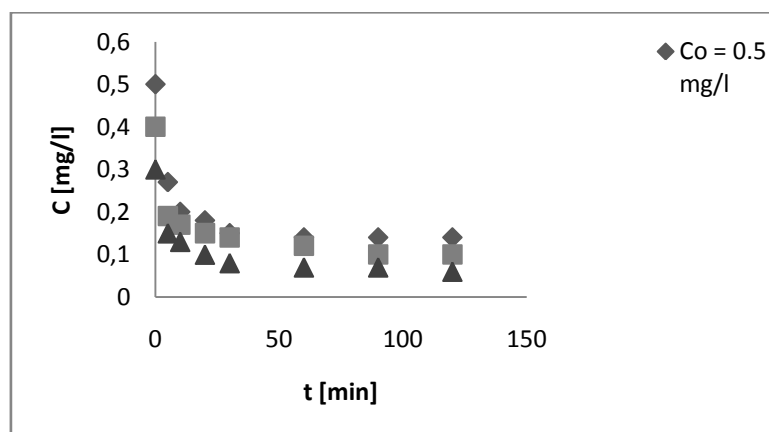

Figure 1. Dependence of initial Ni(II) concentration from time of adsorption

The percentage of removal, %R, of Ni(II) ions was calculated using the following equation:

$$\%R = \frac{C_0 - C_e}{C_0} \cdot 100 \quad (1)$$

where  $C_0$  is initial metal ion concentration [mg/l] and  $C_e$  is equilibrium concentration [mg/l].

The effect of the initial concentration on the percentage of removal is shown in Figure 2. The percentage of removal decreases by increasing the initial Ni(II) ions concentration. At lowest initial metal ion concentration of 0.3 mg/l the percentage of removal is 80% after which it decreases gradually to 75 and 72% at Ni(II) concentrations of 0.4 and 0.5 mg/l, respectively. This happens because at lower initial metal ion concentrations, sufficient adsorption sites are available for adsorption, whereas at higher concentrations, more ions are left un-adsorbed in the solution due to the saturation of the adsorption sites.

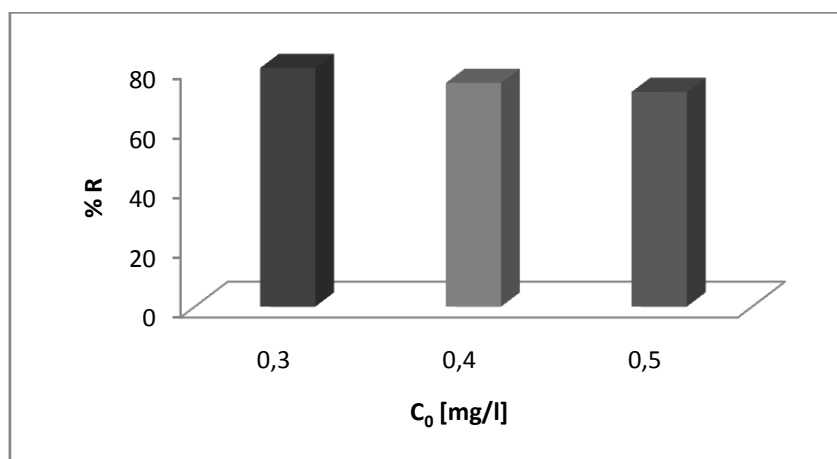

Figure 2. Function of Ni(II) removal from initial concentration

The adsorbed amount of metal ion at equilibrium,  $q_e$  [mg/g], was calculated using the Equation 2.

$$q_e = \frac{(C_0 - C_e)V}{m} \quad (2)$$

where,  $V$  is volume of the solution [l], and  $m$  is mass of the adsorbent [g].

The adsorption isotherms are essential data source to design, understand and optimize the adsorption process. The plot of adsorbed amounts of Ni(II) ions at equilibrium versus equilibrium concentrations is given at Figure 3.

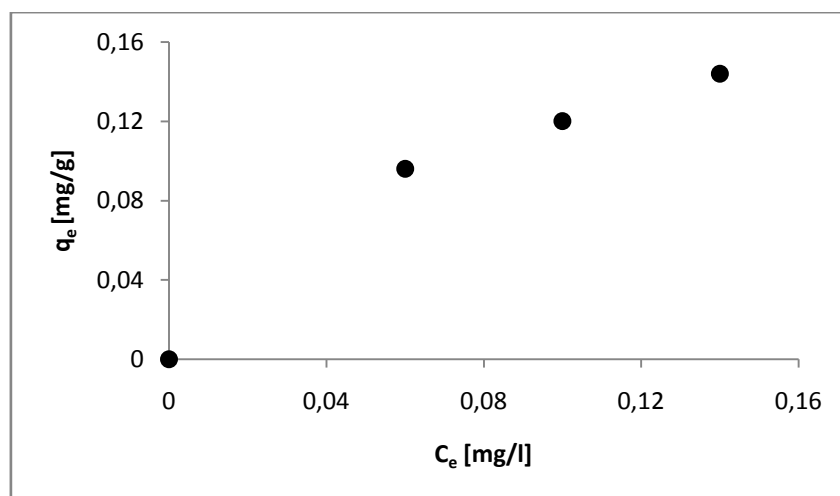

Figure 3. Experimental adsorption isotherm of Ni(II) on natural bentonite

Experimental data were processed by the two most commonly used isotherms: Langmuir and Freundlich. The Langmuir adsorption isotherm is valid for monolayer sorption onto a surface with a finite number of identical sites (Melichova and Hromada 2013) and it can be defined according to the following linear form:

$$\frac{C_e}{q_e} = \frac{1}{q_m b} + \frac{C_e}{q_m} \quad (3)$$

where  $q_m$  is the maximal adsorption capacity [mg/g] and  $b$  is equilibrium constant related to the affinity to the binding site. Diagram of Langmuir adsorption model, obtained by using the experimental results, is shown in Figure 4. The values of  $q_m$  and  $b$ , determined from the linear form of the Langmuir equation and the Langmuir plot, and the coefficient of correlation  $R^2$ , are listed in Table 1.

Freundlich isotherm is used for modeling the adsorption on heterogeneous surfaces and is applicable to monolayer and multilayer adsorption. The linear form of the Freundlich equation is expressed as:

$$\log q_e = \log K_F + \frac{1}{n} \log C_e \quad (4)$$

where  $K_F$  is the Freundlich constant [mg/g] related to the adsorption capacity and  $n$  is an empirical parameter related to the intensity of adsorption. The linear Freundlich plot is given in Figure 5 and the parameters of Freundlich equation as well as the coefficient of correlation are listed in Table 1.

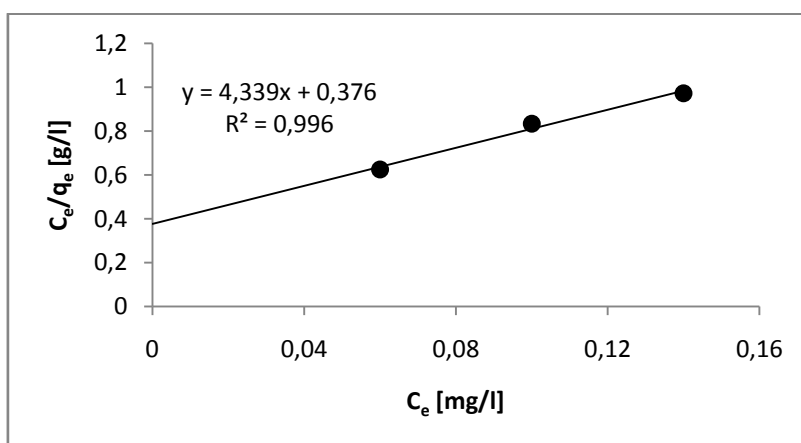

Figure 4. Langmuir adsorption model for Ni(II) on natural bentonite

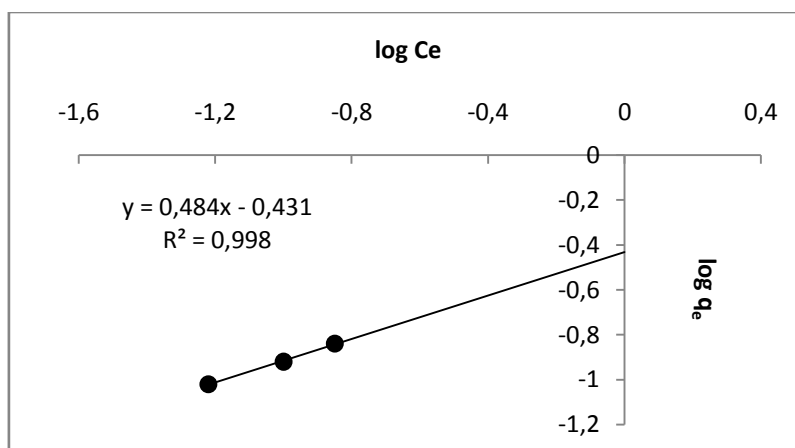

Figure 5. Freundlich adsorption model for Ni(II) on natural bentonite



Table 1. Parameters of the Langmuir and Freundlich isotherms for Ni(II) adsorption on natural bentonite

Langmuir			Freundlich		
$q_m$ [mg/g]	b	$R^2$	$K_F$ [mg/g]	n	$R^2$
0.23	11.56	0.996	0.37	2.1	0.998

The maximal adsorption capacities of natural bentonite for Ni(II) removal, determined by Langmuir and Freundlich isotherms are 0.23 and 0.37 mg/g, respectively.

The linearity of the plots, Figure 4 and Figure 5, confirmed by high values of correlation coefficients reveal that experimental results are well fitted with both applied isotherm models.

## CONCLUSION

In this study, the adsorption of Ni(II) ions on natural bentonite was investigated. The equilibrium data was obtained using the batch adsorption technique. The adsorption equilibria were attained after 50 min. of magnetic stirring for Ni(II) solutions with initial concentrations of 0.3, 0.4 and 0.5 mg/l. The linear form of Langmuir and Freundlich isotherm models were applied to study the adsorption equilibrium data and both models indicate good correspondence to the experimental results. The percentage of the removal of Ni(II) ions at different initial concentrations of 0.3, 0.4 and 0.5 mg/l were 80, 75 and 72 %, respectively.

The results indicate that the natural bentonite could be effectively used as low-cost adsorbent material for the removal of nickel ions from water resources.

## REFERENCES

- Al Dwairi, R. A. & Al Rawajfeh, A. E. (2012). Removal of cobalt and nickel from wastewater by using Jordan low – cost zeolite and bentonite. *Journal of the University of Chemical Technology and Metallurgy*, 47(1), 69 – 76
- Al – Shahrani, S. S. (2012). Treatment of wastewater contaminated with nickel using Khulays activated bentonite. *International Journal of Engineering & Technology*, 12(4), 14 – 18
- Bakalar, T., Bugel, M., & Gajdosova, L. (2009). Heavy metal removal using reverse osmosis. *Acta Montanistica Slovaca*, 14(3), 250-253
- Bernard, E. & Jimoh, A. (2013). Adsorption of Pb, Fe, Cu and Zn from industrial electroplating wastewater by orange peel activated carbon. *International Journal of Engineering and Applied Sciences*, 4, 95 – 103
- Blagica, B., Katerina, A., Gordana, R., Slobodan, B., Bosko, B., Petre, M., & Anita, G. (2014). Adsorption of Fe<sup>2+</sup> and Zn<sup>2+</sup> ions from landfill leachate by natural bentonite from Kriva Palanka (B-KP), Republic of Macedonia. IV<sup>th</sup> International Conference: Ecology of Urban Areas 2014, Zrenjanin, Serbia, Proceedings, 149-156
- Fu, F., & Wang, Q. (2011). Removal of heavy metal ions from wastewater: A review. *Journal of Environmental Management*, 92 (3), 407-418
- Ghormi, F., Lahsini, A., Laajeb, A., & Addaou, A. (2013). The removal of heavy metal ions (copper, zinc, nickel and cobalt) by natural bentonite. *Larhyss Journal*, 12, 37–54
- Kouakou, U., Ello, A. S., Yapo, J. A. & Trokourey, A. (2013). Adsorption of iron and zinc on commercial activated carbon. *Journal of Environmental Chemistry and Ecotoxicology*, 5(6), 168 - 171
- Kyzas, Z. (2012): Commercial coffee wastes as materials for adsorption of heavy metals from aqueous solutions. *Materials*, 5, 1826-1840
- Liu, Z., & Zhou, S. (2010). Adsorption of copper and nickel on Na-bentonite. *Process Safety and Environmental Protection*, 88(1), 62-66
- Lokendra, S. T., & Mukesh, P. (2013). Adsorption of heavy metal (Cu<sup>2+</sup>, Ni<sup>2+</sup> and Zn<sup>2+</sup>) from synthetic waste water by tea waste adsorbent. *International Journal of Chemical and Physical Sciences*, 2(6), 6-19
- Melichova, Z. & Hromada L. (2013). Adsorption of Pb<sup>2+</sup> and Cu<sup>2+</sup> ions from aqueous solutions on natural bentonite. *Polish Journal of Environmental Studies*, 22 (2), 457-464

- Mubarak, N. N., Sahu, J. N., Abdullah, E. C., & Jayakumar N. S. (2014). Removal of heavy metals using carbon nanotubes. *Separation and Purification Reviews*, 43, 311-338
- Nagajyoti, P. C., Lee, K. D., & Sreekanth T. V. M. (2010). Heavy metals, occurrence and toxicity for plants: a review. *Environmental Chemistry Letters*, 8, 199-216
- Rahul, K. J.(2013). Application of electro-dialysis (ED) to remove divalent metals ions from wastewater. *International Journal of Chemical Sciences and Applications*, 4(1), 68-72
- Sarifah, F. S. D., Norzila, M., Nor, H. I. W., Nurul, S. Z., & Nor, F. A. A. B. (2015). Adsorption of lead (II) ions in aqueous solution using selected agro - waste. *ARPN Journal of Engineering and Applied Sciences*, 10 (1), 297-300
- Shaban, J., Katerina, A., Kiril, L., Mirjana, G., Mirko, M., & Stefan, K. (2016). Removal of Ni(II) ions from aqueous solutions by nanoporous material. *Quality of Life*, 7(1-2), 29-35
- Shaheen, S. M., Derbalah, A. S., & Moghanm, F. S. (2012). Removal of heavy metals from aqueous solutions by zeolite in competitive sorption system. *International Journal of Environmental Science and Development*, 3(4), 362-367
- Vindoh, R., Padmavathi, R., & Sangeetha, D. (2011). Separation of heavy metals from water samples using anion exchange polymers by adsorption process. *Desalination*, 267(2), 267-276

V International Conference  
„ECOLOGY OF URBAN AREAS“ 2016

**SORPTION BEHAVIOR DEPENDENCE OF PESTICIDE  
CARBENDAZIM ON DIFFERENT SOIL PROPERTIES**

**Nevena Živančev<sup>1\*</sup>, Srđan Kovačević<sup>1</sup>, Boris Obrovski<sup>1</sup>, Mirjana Vojinović Miloradov<sup>1</sup>,  
Milan Dimkić<sup>1,2</sup>**

<sup>1</sup>University of Novi Sad, Faculty of Technical Sciences, Department of Environmental Engineering, Trg Dositeja  
Obradovića 6, 21000 Novi Sad, Serbia

<sup>2</sup>Jaroslav Černi Institute for the Development of Water Resources, Jaroslava Černog 80, 11000 Pinosava-  
Beograd, Serbia

nevenazivancev@uns.ac.rs; srdjankovacevic@uns.ac.rs; borisobrovski@uns.ac.rs; miloradov@uns.ac.rs;  
milan.dimkic@jcerni.co.rs

**ABSTRACT**

*Pesticides may be detected in all environmental mediums, due to their extensive use in agriculture. Therefore, their presence is monitored in soil, air and water, but also in food and tissues. In the last seven years, the presence of fifteen pesticides from priority and emerging substances list have been continually monitored in surface and groundwaters in Serbia, in sampling campaigns conducted by the Jaroslav Černi Institute for the Development of Water Resources. The results showed that the most frequently detected pesticide in surface and groundwater samples was carbendazim (methyl 2-benzimidazole carbamate). The presence of pesticides in waters depends on their sorption behavior in the soil. The sorption behavior can be assessed using the soil/solution distribution coefficient, commonly referred to as pesticide soil sorption coefficient. In this paper, dependence of carbendazim sorption behavior on various soil properties has been analyzed, by determining the correlation between soil sorption coefficient and the most important soil properties that have an influence on retention and mobility of pesticides in soil. The analysis was conducted using multiple linear regression with a large number of literature data.*

**Key words:** pesticides, carbendazim, soil sorption coefficient, multiple linear regression.

**INTRODUCTION**

The constant growth of human population has resulted in the need for increasing the quantity and quality of food. The main source of food is agricultural production, which uses more and more plant protection products. Constant increase of application of chemicals in agriculture has a potential for contaminating soil, water and air. The pollution of all environmental mediums has a serious risk of affecting the human health, due to direct exposure or through residues in food and drinking water. There are two kind of pesticide contamination sources: point and nonpoint. A point source can be an accidental spill, and a nonpoint source is a source that is not discrete in nature, such as a field where the pesticides have been applied (Sabatini, 1989).

After a pesticide has been applied to the field, its behavior in the environment depends on its structure and physicochemical properties. The other important aspect that influences environmental fate of pesticides are the form, intensity and frequency of its application (Meiwirth, 2003). A part of the active ingredient of the pesticide stays in the area where it has been applied, but some of it gets transported to various environmental mediums. Properties of the region where a pesticide has been applied, such as climate, geology, morphology and hydrology, also have an important impact on the fate of these chemicals.

The most important process that affects pesticides behavior in the environment is their sorption. It is of great importance to research the sorption behavior of pesticides, because it has an influence on other processes that determine their fate in the environment, such as transport, degradation, volatilization and bioaccumulation (Gao et al., 1998; Krishna and Philip, 2008). If a pesticide is not effectively

retained in the soil by sorption processes, it may reach the groundwater, and shallow groundwater tables are the most vulnerable (Meiwirth, 2003). The sorption processes in the soil mostly depend on the organic matter content, soil texture and pH of the soil (Gao et al., 1998; Berglöf et al., 2002; Meiwirth, 2003; Weber et al., 2004; Krishna and Philip, 2008).

In the past 7 years, there have been several surface and groundwater sampling campaigns in Serbia, performed by the Jaroslav Černi Institute for the Development of Water Resources. The collected samples were used to establish the potential pesticide contamination of the four biggest rivers in Serbia: Danube, Sava, Tisa and Great Morava, and the corresponding wells and piezometers. All of the collected samples were analyzed in the laboratory at the Faculty of Technology and Metallurgy in Belgrade. The samples were analyzed to determine the presence of 15 pesticides, and only 7 of them were detected. The most frequently detected pesticide was carbendazim, which was detected in more than 28% of the surface water samples, and more than 22% of the groundwater samples. The second most frequently detected pesticide was atrazine, which was detected in 10% of the surface water samples, and in 27% of the groundwater samples, making it the most frequently detected pesticide in the groundwater samples. It is important to highlight the fact that all of these pesticides were detected in very low concentrations, with only a few exceptions in Morava river samples, when concentrations were 0.165 µg/L (atrazine, May 2010) and 0.269 µg/L (carbendazim, June 2011).

Carbendazim (methyl 2-benzimidazole carbamate) is a systemic broad-spectrum fungicide used in agriculture with fungicidal and fungistatic activities against a wide range of soil fungi (Cancela et al., 1992; Paszko, 2006; Carbo et al., 2007; Li et al., 2011). Aside from the use in agriculture, it can be used as a preservative in paints, textiles, papermaking, leather industry and warehousing practices, and as a preservative of vegetables and fresh fruits (Li et al., 2011). Carbendazim has a slow rate of degradation and a very low solubility in soil, and therefore it can remain in the soil for a long time in an immobilized state (Cancela et al., 1992; Berglöf et al., 2002)

Due to the fact that carbendazim was the most frequently detected pesticide in the water sampling campaigns in Serbia, it has been chosen for further analysis of its behavior in the environment. In this paper, the focus of the research was the behavior of carbendazim in soil. According to Berglöf et al. (2002), this fungicide is retained in the soil with both nonionic and ionic sorption processes. Carbendazim sorption behavior is usually linked to the organic matter content of soil, in various literature data, and also to clay content (Berglöf et al., 2002; Nemeth-Konda et al., 2002; Paszko, 2006; Li et al., 2011). In order to find the soil property that is the most responsible for retention of this pesticide in the soil, a multiple linear regression analysis has been conducted. This type of analysis was performed using a large number of literature data, where sorption behavior of carbendazim was researched in laboratory conditions for different types of soils, with various properties. The analysis was used in order to set a correlation between soil sorption coefficient, usually used as a representative of sorption behavior of a certain pesticide, and different soil properties marked as the most important in the sorption processes: soil pH, texture and organic matter content. The reason for choosing this type of analysis to enable calculating the sorption coefficient for selected pesticide, when only soil properties are available.

## **MATERIALS AND METHODS**

In this paper, multiple linear regression analysis has been performed for carbendazim sorption coefficients. This type of analysis is quite valuable for predicting an unknown value of a variable, from the known value of two or more variables.

The multiple linear regression analysis was conducted using a large number of literature data, where soil properties values were available, to set the correlation between these properties and the sorption coefficients. The main soil properties responsible for sorption behavior of pesticides are pH, soil texture and organic matter content. The data base on which the correlation analysis was performed was organized to use only the values where the soils had less than 10% of organic matter content, because

the main interest of this research are soils in contact with groundwater, where the organic matter is represented in small quantities.

Development of regression equation was performed using Microsoft Excel, with the Solver and Data Analysis Plug-Ins. The main objective was to develop equations based on the most important soil properties that would accurately estimate the linear sorption coefficients for selected pesticides when soil properties are available for a given soil. The linear sorption coefficient was chosen for this type of analysis, due to the fact that models predicting pesticides behavior and transport usually use this type of coefficient (Köhne et al., 2009).

## RESULTS AND DISCUSSION

Multiple linear regression analysis for carbendazim was conducted using literature data, where linear soil sorption coefficients were available, and also the data on soil's pH, organic matter content or soil texture (Berglöf et al., 2002; Paszko, 2006; Carbo et al., 2007; Li et al., 2011; Jin et al., 2013; Ahmad et al., 2015).

The multiparameter linear equation developed from the regression analysis is:

$$K_d = 16.33 + 0.23 \cdot (\text{Clay}\%) - 0.80 \cdot (\text{OC}\%) - 1.88 \cdot (\text{pH}) \pm 7.32 \quad (1)$$

Equation (1) shows dependence of carbendazim linear soil sorption coefficient on clay content (represented in (1) as  $(\text{Clay}\%)$ ), organic carbon content (representative of organic matter content; in (1) designated as  $(\text{OC}\%)$ ) and soil pH (designated as  $(\text{pH})$  in (1)). It also shows that the standard error is quite high.

The difference between literature values and the values gained using the equation derived from the multiple linear regression analysis are presented in Figure 1. Comparison of the literature and calculated values shows very large deviations, and with a high standard error from (1), it leads to a conclusion that this equation cannot be used in predicting linear soil sorption coefficient for carbendazim.

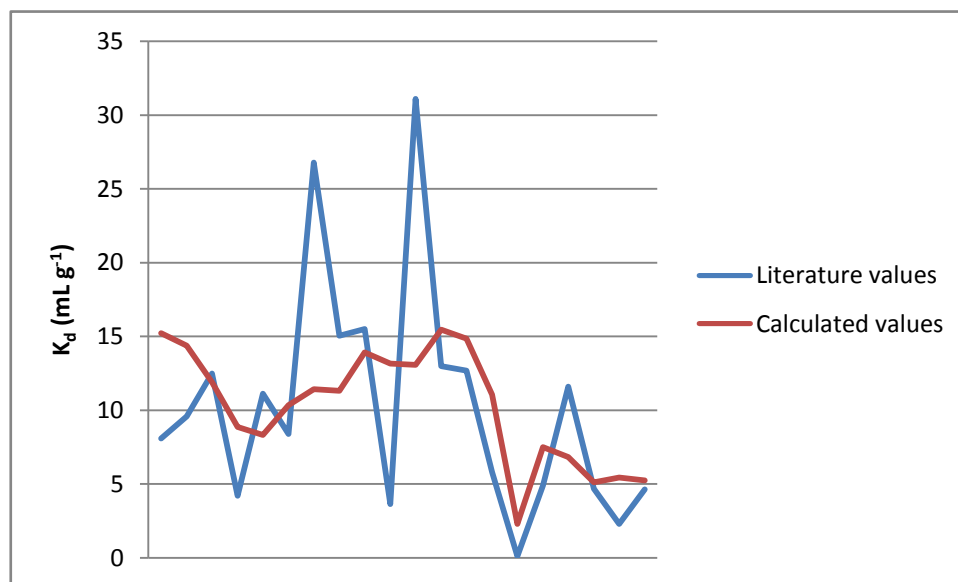

Figure 1. Comparison of literature and calculated values for carbendazim

Linear regression was conducted for each parameter separately, combination of two parameters and for all parameters together. Best results were for the three parameters represented in (1), but these results were still not good enough. It can be concluded that multiple linear regression analysis for carbendazim showed no significant dependence of linear sorption coefficient on soil's pH, organic

matter content or soil texture. To be more accurate, the coefficient for multiple correlation was only 0.50, which is not nearly as high as it should be in order to use this equation for predictions.

It is important to establish which parameters do have an influence on sorption of carbendazim to the soil. This should be the subject of further research.

### INSTEAD OF CONCLUSION

The fate of pesticides in the environment mostly depends on their sorption behavior in the soil. The sorption is a process that influences their further transport through the environment, and that is the reason for choosing this process for research.

In this paper, multiple linear regression was used to establish the dependence of sorption coefficient of fungicide carbendazim on the various soil parameters. This analysis showed that carbendazim sorption behavior cannot be predicted using a multiple parameter linear equation, because the dependence of the  $K_d$  values on soil properties (pH, soil texture and organic matter content) was insignificant. The coefficient for multiple correlation for carbendazim was only 0.50, which is not enough for some serious estimations and predictions. Even more literature data must be examined, but also, some further research should be conducted to establish the connection of sorption coefficient and soil properties. The different sorption mechanisms of carbendazim in soils should also be examined in the further research.

It would be very valuable to establish what are the dominant mechanisms for retaining carbendazim in the soil, because it would contribute to better understanding of their fate in the environment. After their behavior in the soil is understood, it could be easier to predict the risk of groundwater contamination, which is very important, especially in Serbia, where a great number of population gets drinking water from the groundwater resources.

### ACKNOWLEDGEMENTS

This research was supported by the Ministry of Education, Science and Technological Development, Republic of Serbia, under the Project No. TR 37014 and project III 46009.

### REFERENCES

- Ahmad, K. S., Rashid, N., Zahra, T., & Shaheen, I. (2015). Comparative Study of Sorption-Desorption Behavior of Benzimidazole Based Pesticides on Selected Soils. *Eurasian Journal of Analytical Chemistry*, 10(1), 19-33.
- Berglöf, T., Van Dung, T., Kylin, H., & Nilsson, I. (2002). Carbendazim sorption-desorption in Vietnamese soils. *Chemosphere*, 48(3), 267-273.
- Cancela, G., Taboada, E. R., & Sánchez-Rasero, F. (1992). Carbendazim adsorption on montmorillonite, peat and soils. *Journal of Soil Science*, 43(1), 99-111
- Carbo, L., Martins, E. L., Dores, E. F., Spadotto, C. A., Weber, O. L., & De-Lamonica-Freire, E. M. (2007). Acetamiprid, carbendazim, diuron and thiamethoxam sorption in two Brazilian tropical soils. *Journal of Environmental Science and Health Part B*, 42(5), 499-507.
- Gao, J. P., J. Maguhn, P. Spitzauer, and A. Kettrup (1998). "Sorption of pesticides in the sediment of the Teufelsweiher pond (Southern Germany). I: Equilibrium assessments, effect of organic carbon content and pH." *Water Research* 32, no. 5: 1662-1672.
- Jin, X., Ren, J., Wang, B., Lu, Q., & Yu, Y. (2013). Impact of coexistence of carbendazim, atrazine, and imidacloprid on their adsorption, desorption, and mobility in soil. *Environmental Science and Pollution Research*, 20(9), 6282-6289.
- Köhne, J. M., Köhne, S., & Šimůnek, J. (2009). A review of model applications for structured soils: b) Pesticide transport. *Journal of contaminant hydrology*, 104(1), 36-60.
- Krishna, K. R., & Philip, L. (2008). Adsorption and desorption characteristics of lindane, carbofuran and methyl parathion on various Indian soils. *Journal of hazardous materials*, 160(2), 559-567.
- Li, X., Zhou, Q., Wei, S., Ren, W., & Sun, X. (2011). Adsorption and desorption of carbendazim and cadmium in typical soils in northeastern China as affected by temperature. *Geoderma*, 160(3), 347-354.

- Meiwirth, K. (2003). "Regional and local scale pesticide transport in the alluvial plain of the swiss Rhône river valley", EPFL, Thesis No 2869, 110 p.
- Nemeth-Konda, L., Füleky, G., Morovjan, G., & Csokan, P. (2002). Sorption behaviour of acetochlor, atrazine, carbendazim, diazinon, imidacloprid and isoproturon on Hungarian agricultural soil. *Chemosphere*, 48(5), 545-552.
- Paszko, T. (2006). Sorptive behavior and kinetics of carbendazim in mineral soils. *Polish Journal of Environmental Studies*, 15(3), 449-456.
- Sabatini, D.A. (1989). "Sorption and transport of atrazine, alachlor, and fluorescent dyes in alluvial aquifer sands." Ph.D. Dissertation, Iowa State University, Ames, IA.
- Weber, J. B., Wilkerson, G. G., & Reinhardt, C. F. (2004). Calculating pesticide sorption coefficients (K<sub>d</sub>) using selected soil properties. *Chemosphere*, 55(2), 157-166.

V International Conference  
„ECOLOGY OF URBAN AREAS“ 2016

**INDOOR RADON MEASUREMENTS USING SOLID STATE NUCLEAR  
TRACK DETECTORS IN ELEMENTARY AND SECONDARY  
SCHOOLS IN ŠABAC, SERBIA**

**Svetislav Lazarev<sup>1\*</sup>, Luka Nenadović<sup>1</sup>, Jelena Đuričić-Milanković<sup>1</sup>, Bojan Damjanović<sup>1</sup>**

<sup>1</sup> Higher medical and business-technological school of applied studies, Hajduk Veljkova 10, Šabac, Serbia  
svetislavlazarev@vtssa.edu.rs; lnenadovic@ipb.ac.rs;

**ABSTRACT**

*The activity of the radioactive gas radon is measured at 12 different locations of the municipality of Šabac, Serbia, using the solid state nuclear track detectors CR 39. This is the first indoor radon activity concentration measurement conducted in this area. The solid alpha particle detectors were mounted at five elementary and seven secondary schools; the period of exposition being three months. According to the readings, the mean value of the activity concentration of 190 (90) Bq/m<sup>3</sup> was calculated. The result is higher than average for the country and is in agreement with the known values for the adjacent areas, obtained using the same method, which also have fairly elevated levels of the activity concentration.*

**Key words:** radon, nuclear track detectors.

**INTRODUCTION**

Radon is a noble radioactive gas formed in the natural decay chain of uranium. As such, it can be found in every soil and the process of its production is always present. Uranium isotope <sup>238</sup>U decays through a chain of isotopes reaching the radium isotope <sup>226</sup>Ra which finally decays to <sup>222</sup>Rn. This chemical change is followed by the change of state to a gas. The density of <sup>222</sup>Rn being 7.5 times higher than that of the air. As a gas, <sup>222</sup>Rn is very mobile and water-soluble and present in the atmosphere. Its half-decay is 3.825 days. The way one can detect radon decay is by measuring the presence of created  $\alpha$ -particles.

It is considered that a significant ratio of radiation exposure of the world population is due to inhalation of radon and its daughters. Some figures go even up to 60% (Szabó, 2013). Thus, the problem of population exposure to <sup>222</sup>Rn presents the objective to a huge amount of researches conducted world-wide. Inhalation of <sup>222</sup>Rn and its decay products is considered the second main cause of the lung cancer, after smoking. It was pointed out that more than 90% delivered to the lung tissue comes from the short-lived products of radon (Al-Haydari, 2011; United Nations Scientific Committee on the Effect of Atomic Radiation, 2000).

The main source of the indoor <sup>222</sup>Rn on the lower floors of the building is the soil; on the higher floors (2<sup>nd</sup> and higher) is the building material. The latter is reason for the measurement of activity concentration of radionuclides in the building materials before its use. As the significant percentage of population spends most of their time indoors, it is of crucial importance to assess the exposure levels of occupants and find the mechanisms to diminish their impact. The main contribution to the indoor radon concentrations comes from soil content and porosity as so as other geological factors such as uranium content of underground rocks, quality and the type of construction, ventilation, weather conditions and climate.

There are some claims that the space under the living rooms could be responsible for the <sup>222</sup>Rn indoor concentration levels (Todorović et al., 2013). In the cited study, it is reported that out of 747 examined households, about 20% have had a cellar under the living room. The finding was that the existence of the cellars significantly increased the levels of radon activity concentration in the living rooms. The possible explanation is that the gas accumulated in cellars enters directly in the rooms through the cracks and holes in the floor. The same author also concluded that the floor type strongly affects the



radon indoor concentration, obtaining the maximal values for wooden floors. The majority of houses have been found to have a concrete floor, slightly more than 20% have had wooden floors and 18 houses have been found to have packed earthen floor. In the latter two cases, the recommended levels are found to be exceeded.

The  $^{222}\text{Rn}$  emission from the soil at one location may vary over time. These variations in general occur on a daily and seasonal basis. The indoor radon concentrations are usually higher in colder seasons than in warmer ones. This is mainly due to the poorer ventilation during the winter months and the fact that  $^{222}\text{Rn}$  is higher in frozen soil (Forkapić et al., 2007).

International Commission on Radiological Protection recommends the average annual indoor levels up to  $100 \text{ Bqm}^{-3}$  for new houses. All higher levels need different sorts of remedial measures (ICRP, 1993). The Serbian legislative adopted standard of  $200 \text{ Bqm}^{-3}$  for new houses and  $400 \text{ Bqm}^{-3}$  for old ones. The first step, before taking preventive and remedial actions, is to determine the average values of the radon activity concentration in some area. This may suggest whether such actions are necessary.

In this paper we present our results of the measurement of the radon activity concentration in elementary and secondary schools in the municipality of Šabac, Serbia. To this end we used CR-39 solid  $\alpha$ -particle track detectors which were exposed during the period of the 3 months in spring period.

## METHOD OF MEASUREMENT

The activity concentration is the time rate of the radioactive decays per unit volume

$$C(t) = \frac{A(t)}{V}, \quad (1)$$

i.e. the activity of the radionuclide per unit volume of air. To determine the activity concentration in the indoor environment we used solid nuclear track detectors CR-39 or allyl diglycol carbonate (ADC). The detection is due to the traces left by the  $\alpha$ -particles in the fabric of allyl diglycol carbonate thin films. The detectors are small, with the area of  $1 \text{ cm}^2$  with the thickness of 1 mm. The usual way of exposition is such that detector mounted to the wall. It was attached in such a way that only one side was exposed; the other side being protected by the plastic protection film.

After the exposition period, in our case three months, the detectors were etched in a 6M solution of NaOH at the temperature of  $70^\circ\text{C}$  for four hours. As a consequence the  $\alpha$ -particle traces are widened enough to be visible under the microscope. The density of traces is thus determined by the visual counting. This method excludes the detection of  $\beta$  and  $\gamma$ -particles.

The method of counting  $\alpha$ -particle traces consists in division of the detector area into square cells and counting the number of traces in each cell. By doing this we apply the following convention: in each cell we count the traces in it and also the traces on the right vertical and upper horizontal boundary line. The detectors used are divided into 10 areas and photographed under the microscope. The magnification being 100x with the cell area  $S = 1.39 \text{ mm}^2$  (Figure 1).

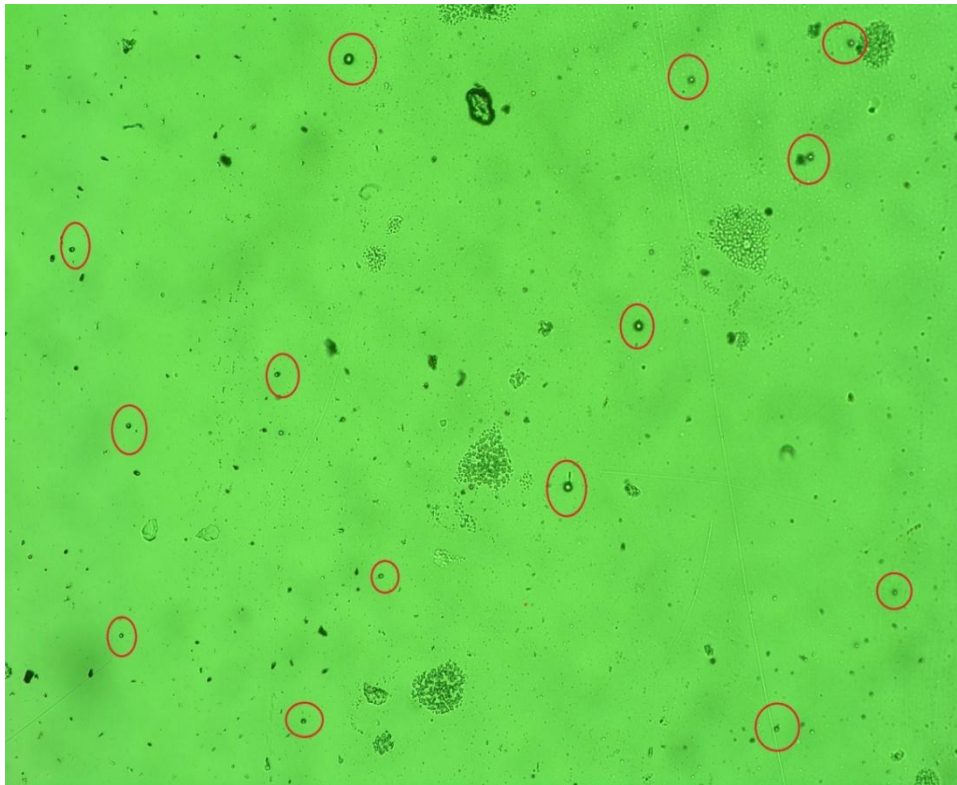

Figure 1: The photograph of the detector with marked  $\alpha$ -particle traces

By the described system of trace counting we obtained the number of traces per volume of the detector area. The corresponding quantity is called the surface trace density  $\sigma$ . We assumed here that the traces are uniformly distributed across the detector. The velocity of traces creation on the surface of the detectors  $d\sigma/dt$ , is proportional to the concentration  $C(t)$  of the Radon in the air surrounding the detector during the exposure time. It is also proportional to the inverse of the  $^{222}\text{Rn}$  half-life period  $T$ , i.e.

$$\frac{d\sigma}{dt} = K \frac{C(t)}{T} = KA(t). \quad (2)$$

where  $A(t)=C(t)/T$ . The proportionality coefficient  $K$ , is the calibration factor of the detector. For the CR-39 detectors we used, the calibration factor is  $K = 3.2 \text{ trag. cm}^{-2}/\text{kBqm}^{-3}\text{h}^{-1}$ .

The exposition time  $t_{ex}$  was 3 months and using the average values (2) can be approximated by the expression

$$\frac{\sigma}{t_{ex}} = K\bar{A}, \quad (3)$$

$\bar{A}$  being the mean concentration of the activity for the exposition period. Therefore we use the following equation to calculate mean activity concentration

$$\bar{A} = \frac{\sigma}{Kt_{ex}}. \quad (4)$$

We have chosen the schools to measure the activity concentration because schools represent the population distribution in some area. The elementary schools represent in some manner households, because there are more elementary schools in urban areas where is higher density of inhabitants. The secondary schools are placed usually in the centre of urban areas which correlates with the distribution of working places on the other hand.

## RESULTS AND DISCUSSION

The results of the indoor radon concentration measurements by CR-39 performed in spring of 2009 are presented in Table 1. The indoor radon activity concentrations have been measured at 12 locations in Šabac, Serbia. The highest radon levels should be expected in basements and ground floors, thus measurements at these are of the outmost significance for the assessment of the radon presence in buildings. On the basis of the obtained results, the average indoor activity concentrations of  $^{222}\text{Rn}$  for elementary and secondary schools in municipalities (Table 3) and in the whole province of Vojvodina were calculated (Table 4).

Table 1: The results of the  $^{222}\text{Rn}$  activity concentration measurement in schools

	Location	Indoor radon concentration ( $\text{BQM}^{-3}$ )
1.	Elementary school "Stojan Novaković",	$217 \pm 36$
2.	Elementary school "Vuk Karadžić"	$262 \pm 44$
3.	Elementary school "Laza K. Lazarević"	$276 \pm 59$
4.	Elementary school "Jevrem Obrenović"	$323 \pm 49$
5.	Elementary school "Janko Veselinović"	$276 \pm 32$
6.	School of music "Mihailo Vukdragović"	$188 \pm 48$
7.	School of economy and trade	$76 \pm 24$
8.	The grammar school of Šabac	$54 \pm 21$
9.	Medical School "Dr Andra Jovanović"	$127 \pm 42$
10.	The school of agriculture	$113 \pm 35$
11.	Chemical and textile school	$258 \pm 79$
12.	Technical school	$95 \pm 42$

Table 2: Statistics of the measurements of indoor radon concentrations by means of CR- during period March 22- June 23, 2009 in Šabac

No. of measurements	$A_{mean}$ ( $\text{Bq m}^{-3}$ )	$\sigma A_{mean}$ ( $\text{Bq m}^{-3}$ )	$A_{geomean}$ ( $\text{Bq m}^{-3}$ )	$A_{min}$ ( $\text{Bq m}^{-3}$ )	$A_{max}$ ( $\text{Bq m}^{-3}$ )
12	189	92	164	54	323

At 3 locations the measured values were below  $100 \text{ Bqm}^{-3}$ , at 3 locations were in the interval  $100\text{-}200 \text{ Bqm}^{-3}$  and at the remaining locations the values were higher than 200 but lower than  $400 \text{ Bqm}^{-3}$ .

Here we present the results of similar measurement in the adjacent regions in Vojvodina (Table 3). In these measurements the same type of CR-39 detectors were used.

Table 3: Measurement conducted in adjacent municipalities in Vojvodina

		$A_{\text{geomean}}$ (Bq m <sup>-3</sup> )	No. of measurements
This study	Šabac	164 <sup>b</sup>	12
Forkapić et al., 2007.	Ruma	175 <sup>a</sup>	28
	SremskaMitrovica	124 <sup>a</sup>	40
	Pećinci	142 <sup>a</sup>	11
	Šid	139 <sup>a</sup>	20
	Novi Sad	87 <sup>a</sup>	86
	BelaCrkva	192 <sup>a</sup>	9
Milić, 2003.	Kosovo Polje	176 <sup>b</sup>	5
		362 <sup>a</sup>	5
	Obilić	123 <sup>c</sup>	15
	Brezovica	52 <sup>d</sup>	30
	Gračanica	104 <sup>b</sup>	5
		196 <sup>a</sup>	5

<sup>a</sup> December-March (winter)

<sup>b</sup> March-June (spring)

<sup>c</sup> 8. December- 8. February

<sup>d</sup> 12. March – 12. May

## CONCLUSION

The hereby presented results concerning the indoor measurement of the activity concentration of the radioactive gas <sup>222</sup>Rn are in agreement with the similar measurements conducted in the surrounding areas of Vojvodina. The obtained values indicate that the levels are slightly elevated to that recommended by ICRP but are in agreement with domestic regulations. All this suggests that further, more precise measurements are needed as so as possible remedial measures in order to reduce the health risks and further exposition of occupants to <sup>222</sup>Rn.

## ACKNOWLEDGEMENTS

The authors want to express their gratitude to Vladimir Udovičić and the Institute of Physics in Zemun, University of Belgrade, for providing detectors and to the Department of Physics, University of Osijek where detectors were chemically treated.

## REFERENCES

- Banjac R, Dragić A, Grabez B, Joković D, Markusev D, Panić B, Udović V, Anicin I. Indoor radon measurements by nuclear track detectors: Application in secondary schools. *Facta Universitatis*, Vol 4 N 1, 2006. 93-100
- Szabó, Z., Völgyesi P, Nagy HÉ., Szabó C., Kis Z., Csorba O., Radioactivity of natural and artificial building materials-a comparative study. *J. Environ. Radioact.* 118, 64–74 (2013)
- Al-Haydari A<sup>1</sup>, Al Sharabi ES, Al Buhairi MH. Determination of specific activity of <sup>226</sup>Ra, <sup>232</sup>Th and <sup>40</sup>K for assessment of environmental hazards. *Radiat. Prot. Dosim.* 1–8 (2011).
- United Nations Scientific Committee on the Effects of Atomic Radiation. Sources and effects of ionizing radiation, *UNSCEAR* (2000).
- The International Commission for Radiological Protection. Protection against radon-222 at home and at work. *ICRP Publication 65* (1993).
- Forkapić S. et al., Indoor radon in rural dwellings of the south - Pannonian region, *Radiation Protection Dosimetry* (2007), Vol. 123, No. 3, pp. 378–383
- Milić G., Distribucija radona u vazduhu zatvorenog prostora u nekim regionima Kosova i Metohije, doktorska disertacija, 2003., Prirodno-matematički fakultet, Univerzitet u Prištini
- Official Journal of Serbia*, No. 36/09, Law on protection against ionizing radiation and nuclear safety.
- Surinder S, Rajeev M, Jatinder K, Lakwant S. Indoor radon measurements in dwellings of Kulu area, Himachal Pradesh, using solid state nuclear track detectors. *Radiation Meas.* 34(2001) 505-508

**ENVIRONMENTAL ASPECTS OF TRAFFIC IN URBAN  
AREA**

V International Conference  
„ECOLOGY OF URBAN AREAS“ 2016

**ANALYSIS OF THE IMPACT OF TRAFFIC DENSITY ON AIR  
QUALITY AT TOLL BOOTH NAIS ON HIGHWAY E75**

**Nikola Mišić<sup>1\*</sup>, Aca Božilov<sup>1</sup>, Ivica Stamenković<sup>2</sup>, Amelija Đorđević<sup>1</sup>, Nenad Živković<sup>1</sup>,  
Ljiljana Živković<sup>1</sup>**

<sup>1</sup>Faculty of Occupational Safety, University of Niš, Serbia

<sup>2</sup>Faculty of Technology, University of Niš, Serbia

nikola.misic@znrfak.ni.ac.rs, aca.bozilov@znrfak.ni.ac.rs, stamenkovicivica72@gmail.com,  
amelija.djordjevic@znrfak.ni.ac.rs, nenad.zivkovic@znrfak.ni.ac.rs, ljiljana.zivkovic@znrfak.ni.ac.rs

**ABSTRACT**

*The degradation of the air quality, which is the most sensitive component of the environment, represents one of the main problems facing modern society. There are many sources of pollution that affect its quality, and the one that stands out as the most important is traffic (Colvile, et al., 2000). Exhaust gases from traffic that lead to air pollution are conditioned by: traffic density, types of vehicles, speed of movement, age of vehicles and types of fuel. Studies have shown that on the roads in jam places, intersections and the like, are formed increased ambient concentrations of pollutants (WHO, 2000). In order to determine the dependence between traffic density and air quality in jam places downtime, measuring of the concentrations of pollutants in ambient air at the toll booth Nais on highway E75 was conducted. Monitoring was carried out by automated measuring station "Airpointer®" in the period from 1st to 31st August 2014. Based on the number and categories of vehicles registered at the toll booth Nais in this period and the measured concentrations of pollutants (CO, NO<sub>2</sub> and O<sub>3</sub>) in ambient air, the impact of the traffic frequency and the categories of vehicles on change of the air quality (expressed in AQI) in the region was determined.*

**Key words:** traffic, air quality, AQI.

**INTRODUCTION**

Because of the population density, intense traffic, fossil fuel combustion and industrial activities, the environment has become specific in terms of the assessment of air quality, as was as from the aspect of assessment of the risk from different pollutants (WHO, 2000). Rapid economic and technological development and increased consumption of fossil fuels has caused a sharp rise in air pollution, especially in urban areas. Rapidly increasing traffic intensity specifically contributes to increasing emission of pollutants into the atmosphere (Colvile, et al., 2000).

Emissions of pollutants from traffic are a significant source of air pollution. The transportation sector is a major source of emissions of nitrogen oxides (NO<sub>x</sub>) and carbon monoxide (CO), as well as a source of volatile organic compounds (VOC) and dust particles (PM<sub>2.5</sub>). The amount of emissions of pollutants from traffic are in correlation with the number of the vehicles and the way that vehicles are moving in a specific time interval (Vidaković, 2013). The characteristics of traffic artery tracks and jam places at them also contribute to the increased air pollutant emission (Huberman, et al., 2011).

Based on these findings, the Laboratory for air quality management of the Faculty of Occupational Safety in Nis, carried out a study whose objective was to determine the effect of the traffic density and categories of vehicles on a highway in jam places on air quality.

Toll booth Nais on the highway E75, near the city of Nis, was chosen as the object of the research, and the task was to monitor the concentrations of pollutants in ambient air, which are formed as a result of the traffic. The measurement was performed in the period from 1 to 31 August 2014.

Traffic intensity was especially evident in the period from July to September, when the passage of tourists and workers from the EU to Greece and Turkey through the toll booth is increased.

The toll booth is part of the road where vehicles are stopping for a short period of time due to toll collection. The formation of columns of vehicles at toll booths in the summer months is very common, and thus the traffic flow is much slower. In this case, due to the increased number of vehicles, an increased pollutant concentrations in close environment can be expected.

Monitoring of the concentrations of pollutants (CO, O<sub>3</sub>, NO<sub>2</sub>) in ambient air and the meteorological data (temperature, wind speed and direction), was carried out at the toll booth Nais on the highway E75, by automated measuring station "Airpointer®", that was located along the highway, 55m southeast from the toll booth (see Figure 1).



Figure 1. Location of measuring point at the toll gate Nais



Figure 2. The measuring station "Airpointer®" at the measuring point – tollbooth Nais on highway E75

## METHODS AND MATERIALS

The applied method for identification and proving of the stated objectives in this paper, is based on a combination of methods for data collection - measurement, experiment and method of data analysis.

The research is based on monitoring of the pollutant concentration in the ambient air continuously for a period of 30 days. After that, the statistical treatment, correlation and regression analysis of the collected data were performed.

Measuring of the CO, O<sub>3</sub>, and NO<sub>2</sub> concentrations in ambient air, at the toll booth Nais, was carried out by portable automated measuring station "Airpointer®". The station is a complex system, which includes modules and sensors for monitoring these substances and meteorological data, and embedded computer for collected data processing, analysis and distribution.

The measuring station "Airpointer®" at the measuring point is shown on Figure 2.

For the measurement of the concentration of carbon monoxide a method based on nondispersive infrared spectroscopy was used, according to standard EN:14626; for nitrogen oxides chemiluminescence method, according to standard EN 14211, and for ozone, method based on ultraviolet photometry, according to standard EN 14625 (Airpointer, 2014).

The average daily values of the measured concentration of CO, O<sub>3</sub>, and NO<sub>2</sub> in month of August, are shown in Table 1.

Table 1. The average daily values of the concentration of CO, O<sub>3</sub>, and NO<sub>2</sub>

Date	CO [ppm]	O <sub>3</sub> [ppb]	NO <sub>2</sub> [ppb]
01.08	2,324	17,487	22,957
2.08	2,256	19,741	20,110
03.08	2,232	28,577	12,988
04.08	2,350	26,926	13,856
05.08	2,188	30,021	15,306
06.08	2,297	22,569	15,705
07.08	2,460	21,468	19,505
08.08	2,364	22,376	12,686
09.08	2,438	18,794	14,132
10.09	2,438	21,942	10,963
11.09	2,457	21,882	10,874
12.08	2,450	25,133	10,407
13.08	2,404	27,91	8,804
14.08	2,435	34,718	14,117
15.08	2,556	21,557	25,696
16.08	2,562	22,724	16,351

Date	CO [ppm]	O <sub>3</sub> [ppb]	NO <sub>2</sub> [ppb]
17.08	2,485	22,006	15,784
18.08	2,463	21,751	11,560
19.08	2,520	22,407	12,995
20.08	2,607	25,679	14,899
21.08	2,644	22,136	13,674
22.08	2,670	22,409	12,183
23.08	2,760	22,381	12,748
24.08	2,777	25,139	14,125
25.08	2,721	19,989	14,265
26.08	2,740	22,582	12,826
27.08	2,790	31,688	7,398
28.08	2,800	21,356	18,873
29.08	2,890	20,538	18,170
30.08	2,987	21,692	22,328
31.08	3,012	28,123	15,125

Graphic interpretation of measured concentration of CO, O<sub>3</sub>, and NO<sub>2</sub> are shown in Figures 3 and 4.

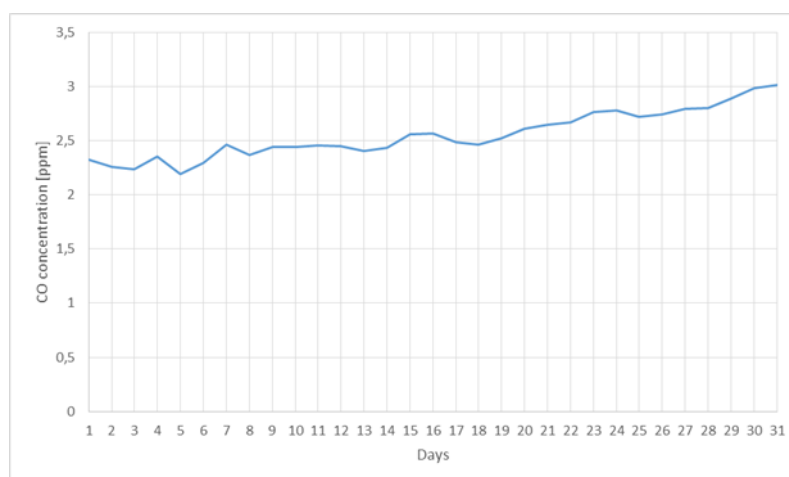

Figure 3. Average daily values of the CO concentrations

There is a trend of CO concentration increasing from the beginning to the end of the measuring, which can be seen on the diagram shown on Figure 3.

The line of O<sub>3</sub> concentration change has fractured character (see Figure 4). There isn't a changing trend, but there is a significant increase of concentration as we near the end of the week, and decrease as we move away from the weekend days. Turning points of the maximum concentrations are in days Saturday – Sunday, and minimum in Wednesday-Thursday.

The line of NO<sub>2</sub> concentration change also has fractured character with minimum and maximum appearance. Spotted characteristics is that in days when O<sub>3</sub> concentration has a growing character, NO<sub>2</sub> concentration has a declining one.



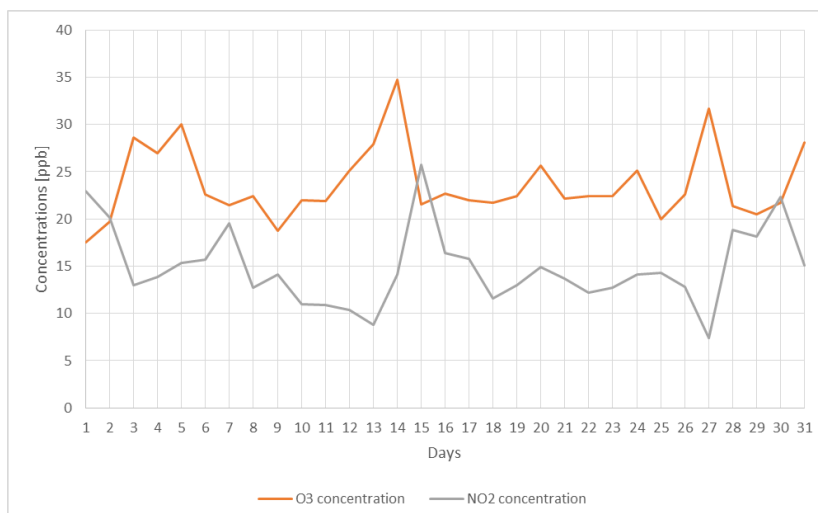

Figure 4. Average daily values of the  $O_3$  and  $NO_2$  concentrations

Determining the air quality was done by using an Air Quality Index – AQI (AQI, 2016). Based on measured values of  $CO$ ,  $O_3$ ,  $NO_2$  concentration, averaging their values were performed, for  $CO$  and  $O_3$  on average daily values for 8 hours, and for  $NO_2$  on average value for each hour, and also were calculated: AQI ( $CO$ ), AQI ( $O_3$ ) and AQI ( $NO_2$ ). Air quality was determined for maximum value of AQI on that day.

AQI daily values for  $CO$ ,  $O_3$ ,  $NO_2$ , for August are shown on Figure 5. In all analyzed days, AQI was below 50 which corresponds to good air quality, except in one day, when it was above 50 (15.08.2014.).

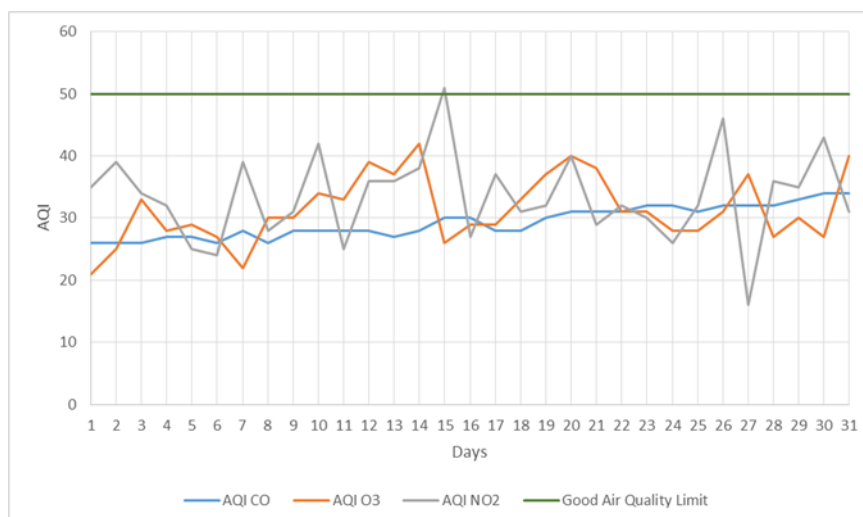

Figure 5. Daily AQI for  $CO$ ,  $O_3$ , and  $NO_2$  in August

Data about the number and category of vehicles, were taken from Public Enterprise "Roads of Serbia" database of the traffic flow. Number of vehicles in categories I, II, III and IV, which undergo a ramp Nais (in both directions) is given for each day (starting records per day at 07:00). For this reason, the measured data on the pollutants are generated in the manner as shown in Table 1.

The total daily number of vehicles and the number of vehicles in category I and category II + III + IV, in August at the toll station Nais, is shown in Figure 6. The first category relates primarily to cars that use gasoline as a motor fuel and the sum of category II + III + IV to vehicles that use diesel fuel.

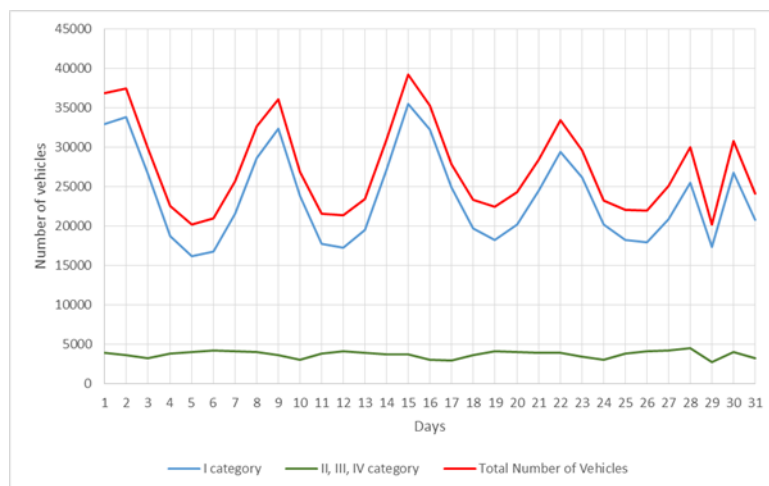

Figure 6. Preview the total number of vehicles per category in August

In the observed period, the trend of the total number of vehicles and the vehicles of category I slightly decreased, while the trend in the number of vehicles II, III and IV categories was unchanged.

During the measurement of pollutants, meteorological data were also measured. Since that the dominant influence on the dispersion of air pollution in the atmosphere has a wind speed and wind direction, this element was included in the analysis. Formed wind rose for the month of August (see Figure 7) shows that the dominant wind direction was from the direction NW - SE, apropos from the direction of generating pollution from the toll gate Nais (an area bordered by the ellipse). Winds from SSW-SSE direction are relevant for consideration in view of the fact that they prevent the dispersion of the pollution to the measuring station.

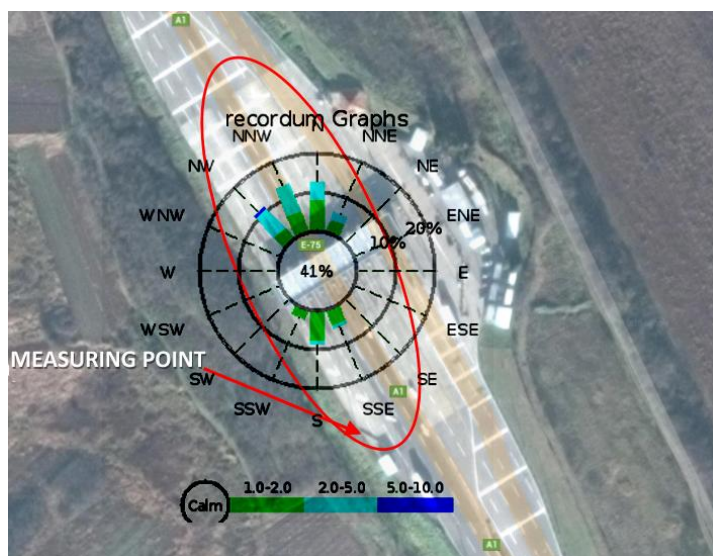

Figure 7. Wind rose for August in the area toll booth Nais

## DISCUSSION OF RESULTS

Results analysis of conducted monitoring for CO, O<sub>3</sub>, NO<sub>2</sub> concentration, derived from combustion engines, in order to determine the contribution of vehicles to air quality changes in jam places, indicates on the following points:

- The general statement, which can be set, is that in the analyzed period there is a trend of reducing the number of vehicles which are coming to the toll booth and growth trend of the CO concentration. Since that the structure of vehicles has not changed significantly in this period, distribution of CO in the atmosphere on toll booth surrounding has meteorological parameters, and apropos the dominant role was taken by northwest wind. It is also notable that the CO concentration change is not in correlation with the total number of vehicles on weekends. This can be explain by the fact that the number of second, third and fourth class of vehicles is not significantly changed during the weekend, compared to other days.
- Contribution of CO emissions on the air quality change, from vehicles that fit on the toll gate, is shown in Figure 8. In the analyzing period between the number of vehicles and CO AQI value, there was a negative correlation. This leads to the conclusion that the meteorological elements in this period had a major role on the forming CO concentrations at the measuring point, and thus the value of AQI CO.

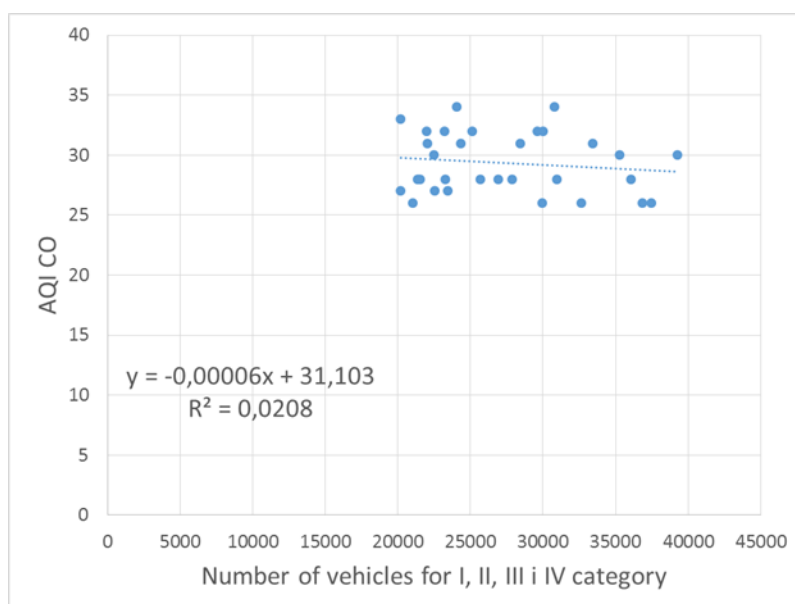

Figure 8. Dependence of AQI CO and the total number of vehicles

Changing the NO<sub>2</sub> concentration in the atmosphere of the toll gate follow the changing trend of the number of vehicles in the week and in the entire analyzed period.

The effect of increasing the number of vehicles that fit on the toll booth on the AQI value for NO<sub>2</sub>, is shown in Figure 9, with correlation line which showing that the increase the number of vehicles coming to an increase in NO<sub>2</sub> concentrations in the surrounding of the toll booth, or increase the AQI value for NO<sub>2</sub>. This correlation was expected.

O<sub>3</sub> concentration which forms at the toll booth surrounding follow the trend of vehicle numbers and NO<sub>2</sub> concentrations change, where the minimum and maximum occur with a delay of approximately 24 hours (see Figure 3). Considering that for the forming O<sub>3</sub> concentration, among other factors, nitrogen oxides has a significant impact, and for that it requires some time, it is realistic to expect the occurrence of a maximum concentration of O<sub>3</sub> with delaying.

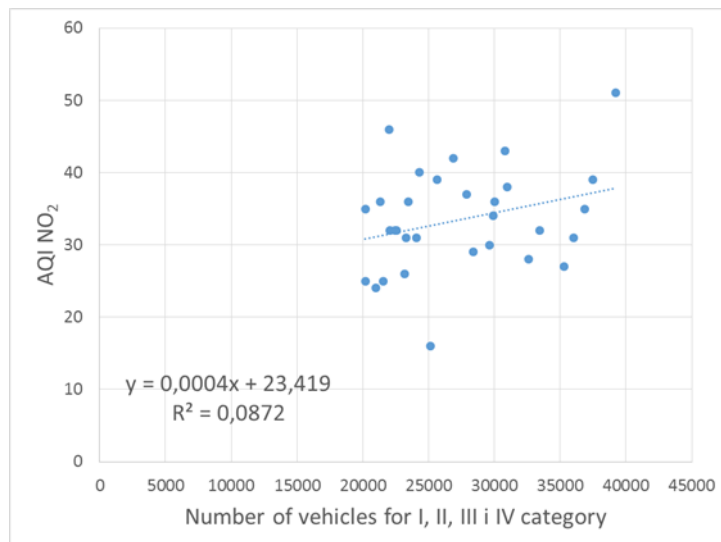

Figure 9. Dependence of AQI NO<sub>2</sub> and the total number of vehicles

Dependence between AQI O<sub>3</sub> and the number of vehicles that fit on the toll booth, has a negative correlation. Correlation line is shown in Figure 10, and it shows that with increasing the number of vehicles there is no increase in the value of AQI O<sub>3</sub>. Such dependence implies that in this period existed and other factors, such as weather conditions that have influence on the dispersion of O<sub>3</sub> and decreasing its concentration.

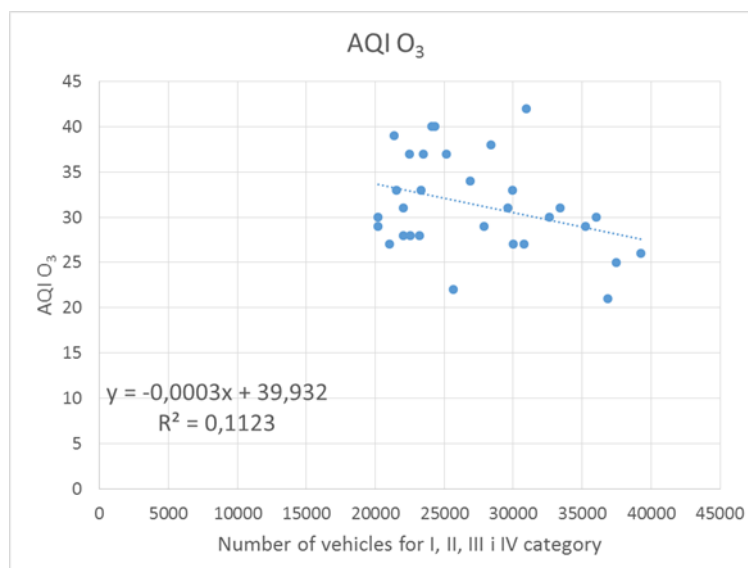

Figure 10. Dependence of AQI O<sub>3</sub> and the total number of vehicles

## CONCLUSION

The well-known attitude is that in jam places downtime appears increase in the concentration of pollutants in the air. Proceeding from this, the aim of the research was to determine the dependence between traffic density and air quality in jam places downtime.

The research was conducted on the Nais toll booth on highway E-75, which is located in a rural area and is not affected by other sources of pollution, except for traffic.

Based on the conducted monitoring, processing, analysis and result discussion, it can be concluded that the dependence between the increase the number of vehicles in delays places on roads and air quality changes in their environment, was determined.

- Values for AQI CO were caused by the frequency of heavy vehicles (vans, trucks and buses) at the toll booth.
- The values for AQI NO<sub>2</sub> and AQI O<sub>3</sub> were caused by car frequency and follow the trend of their weekly changes at the toll booth.
- Determined AQI values for CO, NO<sub>2</sub> and O<sub>3</sub> were below the limit of 50, which defines the upper limit of good air quality, so there is no risk to the health of workers and users of the toll booth.

## ACKNOWLEDGEMENT

Research was performed within the project III 43014 entitled “Improving the system of monitoring and evaluation of long-term human exposure to pollutants in the environment using neural networks“, funded by the Ministry of Education, Science and Technological Development of The Republic of Serbia.

## REFERENCES

- Airpointer. (2014). Instruction Manual. Vienna: Recordum Messtechnik GmbH.
- AQI Calculator, AirNow. [Online]. Available at: [https://airnow.gov/index.cfm?action=resources.conc\\_aqi\\_calc](https://airnow.gov/index.cfm?action=resources.conc_aqi_calc)
- Colville, R. N., Hutchinson, E. J., Mindell, J. S. & Warren, R. A. (2000). The Transport Sector as a Source of Air Pollution. *Atmospheric Environment*.
- Huberman, M., Medeiros, A. P. P. & Gouveia, N. (2011). Vehicular traffic as a method to evaluate air pollution in large cities. *Rev Bras Epidemiol*, 1(14), 1-11.
- Vidaković, D. M. (2013). Višekriterijumska analiza kvaliteta vazduha u urbanim sredinama u zavisnosti od vremenskih faktora. Beograd: Univerzitet u Beogradu, Tehnički fakultet u Boru.
- WHO, 2000. Air Quality Guidelines for Europe. Second edition: WHO Regional Publications.

## **NOISE AND VIBRATIONS IN URBAN AREAS**

V International Conference  
„ECOLOGY OF URBAN AREAS“ 2016

## USING PLANT MATERIALS FOR NOISE POLLUTION IN CITYSCAPE

Aysun TUNA\*<sup>1</sup>, Parisa ALIASGHARI KHABBAZI<sup>2</sup>

<sup>1</sup>Inonu University, Faculty of Fine Art and Design, Department of Landscape Architecture, Malatya, Turkey

<sup>2</sup>Ankara University, Agriculture Faculty, Department of Landscape Architecture, Ankara, Turkey

aysuntuna17@gmail.com, p.aliasghari.au@gmail.com

### ABSTRACT

*As plants make up ecological structure within urban living areas, they also form a vital element of cityscape. Trees/vegetation have a significant functionality within urban landscape of different characteristic and size. Physical and functional characteristic of planting made at urban primarily are the reduction of noise which is one of the major problems for developing countries and has been demonstrated by researchers that increases the risks related to personal health. Noise pollution is increasing parallel to industrial development, population growth and unplanned urbanization. Noise blocking plants, which are used in urban areas where refracted noise from hard surfaces such as buildings and pavement, are problematic. This paper aims to evaluate the role of the plant materials in reducing noise pollution on the cityscape examples with different climatic conditions in Turkey.*

**Key words:** *Noise pollution, plant material, cityscape, Turkey.*

### INTRODUCTION

Noise that is generally defined as excessive or unwanted sounds has become the biggest obstacle to a healthy life in every country in the world. Noise disrupts the natural rhythm of city life and can cause psychological problems and permanent hearing loss.

Many studies have been carried out for many years in order to minimize the harmful effects of noise that disturbs society. In terms of Landscape Architecture, the use of plant material in the solution of this problem is of great importance.

Therefore, the purpose of this study is to reveal the noise problem and to develop proposals by examining the methods used, the results and the studies on the use of plant material in the areas with different climatic conditions in Turkey for solving this problem.

Noise is defined as an audio spectrum that has a random structure and subjectively unwanted audio format. Noise control is the process of removal of harmful effects completely or reduction to a reasonable level by using the methods such as to reduce the sounds that have the characteristics of noise emitted from any audio source to an acceptable level, to change the acoustic properties, to reduce the duration of effect, to mask it with another sound likable or less disturbing.

The hearing threshold of the human ear is 0 dB(A) and humans don't feel any discomfort due to the sounds between 0-30 dB(A) but it is observed psychological symptoms in sounds between 30-60 dB(A) depending on personal sensitivity according to research conducted by the World Health Organization and the International Labour Organisation. It is observed psychological + physiological symptoms in sounds between 65-85 dB(A) and psychological + physiological + potologic disorders in sounds between 95-120 dB(A). It is formed the ear pain and severe disorders in nerve cells in higher sounds than 120 dB(A) (Anonymous 2016).

## Noise Pollution Control

Noise control is the process of removal of harmful effects completely or reduction to a reasonable level by using the methods such as to reduce the sounds that have the characteristics of noise emitted from any audio source to an acceptable level, to change the acoustic properties, to reduce the duration of effect, to mask it with another sound likable or less disturbing. Noise control can be done in three ways including at the source of the noise, in the environment in which it spreads and in the user affected by noise (Anonymous 1999).

The methods to be used in noise prevention:

- The prevention or reduction of noise in the source: The methods to minimize the industrial noise and traffic noise level are used particularly. (Encouraging the use of quieter equipment for factories, reduction of the noise level of the vehicle engines, the correct calculation of the slopes and sharp turns of the roads and the correction of the surface coatings).
- Usage Control (proper use of the source used): Ensuring the control of high volume instruments (horn, speaker, etc. for urban areas) continuously by certain legislative measures.
- Land use (The methods such as land use in appropriate topographical structure, creating a suitably sound insulation are used): It is listed as ensuring sufficient distance between the noise source and the area to be affected, topography interventions and planning the sound barriers in case that sufficient distance is not able to be provided (Alparslan and Erdem, 1987).

The screening methods created by artificial barriers and living materials are used in the prevention or reduction of traffic noise emerged as a major problem in urban areas. The artificial barriers called as sound barriers consist of the walls formed with cement-based or plastic-mixed materials if the sound source and the area to be affected are too close to each other. Such barriers are widely used in mainly urban street in where traffic and urban texture are intense due to the high cost.

### The plant materials in noise prevention

The significant reductions in the amount of sound waves reaching the receiving environment occur by refracting, reflecting and being absorbed the sound waves as the result of the screening by using plant cover (grass, ground cover, shrub and tree groups) on the ground between the noise source and the receiving environment (Aylor, 1972). 100 meters of plant cover can absorb 5-6 dB(A) sound waves. Considering that the reduction in the amount of noise increases with distance, this reduction reaches 20-30 dB(A) a limit. Noise reduction values of groups of trees with 30 m wide that start from 15 m to the traffic lane in highways and city traffic are given in Table 1.

Table 1. The amount of sound absorbed by a distance (Aktas, 2002)

Distance (m)	Absorbed amount (dB(A))
30	5
46	8
69	10

According to the trials made in Austria concerned with the utilization of plant material against traffic noise; pyramid poplar groups situated roadsides demonstrated their reflecting and absorption properties diminishing traffic noise level as in the resonance function of concave surfaces during their swinging and bending with the wind. Again, as a result of the trials made on this issue in Germany, bush groups with a thick structure and low height, in addition to trees with a good crown system and high trunk can prevent dispersion of traffic noise to the environment substantially.



A research conducted in Nebraska, America found that vegetation barriers could not be adequate to prevent inner city traffic noise because a vegetation strip of minimum 20-25m width is required to prevent noise. Yet, vegetation fences of various length and width were used in a research. The entirety of these species with different leaf lengths, shapes and tissue properties were selected as evergreen. The widest vegetation fence was formed of an evergreen plant species "*Illicium anistatum*" of 240 cm. height and 240 cm. width, and fences of 150 cm. length and width were formed of an evergreen conifer with wide leaves "*Pittosporum tobira*" of 210cm width and height. Various noise sources were used and sound levels at various distance and height to the noise source were measured. It was seen that these fences decreased noise level 3-6 dB when the noise level was measured at 3-6m away and above 90cm from the control point.

An "*Illicium anistatum*" fence situated 6m away decreased the car-noise travelling at 30, 60, 90km velocities an hour by 3, 6, 10 dB(A).

Required properties to ensure an effective reduction of noise curtains to be created by plant material are listed as follows (Wilmers, 1990):

- It should be selected noise-reducing plant species that noise-canceling features and effects were determined by researches conducted considering its local distributions.
- The plant species with should be selected with a rich branch and leaf tissue extended to the ground so as to reduce the noise emitted.
- Indeciduous species should be selected,
- Groups of trees and shrubs should be selected from among the species that can create intense rows in line with underground impermeable bush combinations.

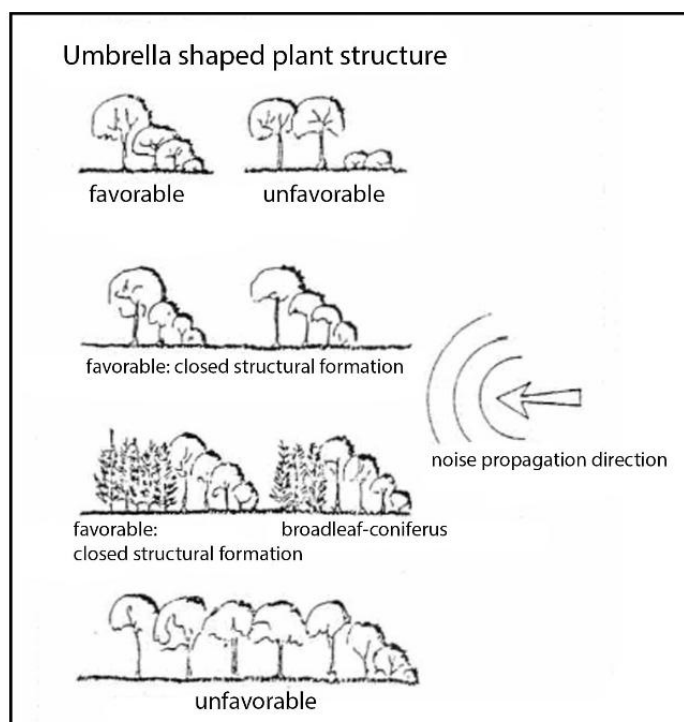

Figure 1. The combination of plant material againts noise (Onder, 2010, Mutlu, 2010)

Bernatzky (1978) and Bayraktar (1980), have divided plant material types to be used in noise curtains formed by plant material and noise reduction values into six groups.

1. Group plants (noise reduction value 0-2 dB(A)): *Salix elaeagnus*, *Picea glauca coica*, *Chamaecyparis laws*. *Glauca*, *Salix alba vit.*, *Thujopsis dolabrata*, *Sophora japonica*, *Buxus*

*sempervirens arborescens, Salicif., Cotoneaster multiflorus, Picea asperata, Spirea vanhouttei, Taxus bacatta*

2. Group plants (noise reduction value 2-4 dB(A)): *Chamaecyparis obt. nana., Rhodotypos scandens, Ligustrum vulgare, Crataegus monogyna, Caragana arborescens, Pyracantha coccinea, Prunus mahaleb, Rosa multiflora, Lonicera korolkowii, Sorbaria sorbifolia, Lonicera tatarica, Chamaecyparis pisifillif. Chamaecyparis lawsonian*
3. Group plants (noise reduction value 4-6 dB(A)): *Juniperus chinensis pfitzeriana, Forsythia x intermedia, Betula pendula, Sambucus nigra, Lonicera maackii, Lonicera ledebourii, Alnus incana, Acer negundo, Crataegus x prunifolia, Populus canadensis Hybriden, Cornus alba, Corylus avellana, Cornus sanguinea, Tilia cordata, Pterocarya fraxinifolia. Lonicera tatarica*
4. Group plants (noise reduction value 6-8 dB(A)): *Philadelphus pubescens, Ilex aquifolium, Carpinus betulus, Ribes divaricatum, Syringa vulgaris, Quercus robur, Fagus sylvatica, Rhododendron sp.*
5. Group plants (noise reduction value 8-10 dB(A)): *Populus borelinensis, Viburnum rhytidophyllum, Viburnum lantana, Tilia platyphyllos*
6. Group plants (noise reduction value 10-12 dB(A)): *Acer pseudoplatanus*

Natural and artificial elements to reduce the noise can be combined. The use of artificial noise curtains by integrating with earth mounds and plant covers (shrubs and climbing plants) is more effective in preventing noise. Noise screens made of only plants may not be economical in terms of area. The use with artificial curtains will save space and provide positive contribution esthetically, besides, the plants will absorb emissions, particulates and heavy metals produced by road traffic. In this regard, the climbing plants (especially *Hedera helix, Rubus fruticosus, Polygonum aubertii* ve *Parthenocissus quinquefolia* species) are often recommended (Report, 1991).

### **Studies Against To Noise Pollution in Turkey**

The researches generally associated with herbal noise curtains that its noise reduction levels were detected and conducted in geographic areas with different climatic conditions in Turkey were examined in this part of the study.

Erdogan and Yazgan have tested possible suitable species for Ankara and realized the noise measurements in the study conducted in 2007 for Ankara located in Central Anatolia that is the capital of Turkey, in order to select live material for reduction of traffic noise problem. Considering the growing conditions, *Chamaecyparis lawsoniana, Cupressus sempervirens, Leylandii, Cupressus sempervirens cv. Glauca, Thuja orientalis* from coniferous species and *Philadelphus coronarius, Forsythia intermedia, Lonicera tatarica, Pyracantha coccinea, Crataegus monogyna* from broad-leaved species were used as experimental materials. Mentioned species have planted in plots located in Ankara-Istanbul highway so as to form the plant curtains with three-lane linearly and measurements have been made for one day by using a sound level meter. Traffic density of the sample space has been determined as 11,000 vehicles according to the daily average of measurements carried out by Republic of Turkey General Directorate of Highways, Transportation Works Department. The noise level of the road has been measured as 80 dB(A) a at times when traffic is dense according to the measurements conducted as naked without plant material. This value has been found to be 75 dB(A) a between the same hours with green curtain created with plant material (Erdoğan and Yazgan, 2007).

The noise measurements were performed at a location 25-50 and 75 m away from the noise source E-80 State Highway with a high traffic density in Erzurum, in the study named “*Determination of roadside noise reduction effectiveness of Pinus sylvestris L. and Populus nigra L. in Erzurum, Turkey*” and conducted by Ozer et al (2014).

According to the results; at the distance of 25 m. from the source, *P.nigra L. and P.sylvestris L.* and the comparison Pinus and Populus, 3, 9.3, 6.3 dB(A) ; at the distance of 50m. 2.5, 5.3, 2.8 dB(A); at the distance of 75 m. 2.4, 5.7, 3.3 dB(A) reduce the traffic noise level. From the study it was found that the Pinus area reduced noise more than populus. The reason for the fact that pine trees are more leaf density than poplars and this reduction effect by pines can be predominant whole year because of evergreen. This is an advantage for the Erzurum city where has relatively hard climatic features.

It has found that the vegetation zone with a width of 5 m and consisting of *Berberis thunbergii - Pyracantha coccinea* from the combinations of the bush reduces the noise 6.3 dB(A), the vegetation zone with a width of 9 m and consisting of *Spiraea vanhouetti – Cotonaster dammerii - Pyracantha coccinea* reduces the noise 5.5 dB(A), the vegetation zone with a width of 20 m and consisting of *Cotonaster dammerii - Juniperus horizontalis - Spiraea vanhouetti* reduces the noise 6.2 dB(A) , according to a study conducted in Konya city situated in Turkey's Central Anatolia. From the study, using shrubs and the groups of shrubs of which reduce the noise perceivably has been determined. Besides, as one after the other group, doing noise screens which are more effective for reduce the noise has determined. (Measurements have been made three times and their averages have been taken) (Mutlu, 2010).

## CONCLUSION

Regarding the investigations carried out in Turkey, it can be said that the use of plants is effective against traffic noise. According to the findings obtained, the principles to be considered in using the plants in order to achieve the targeted success from plant noise curtains:

- Planting area should be at least 5 m wide (This width can be up to 30 m).
- The plants to be used should be selected from natural vegetation as far as possible or natural vegetation should be used together with the appropriate species in order to reduce plant and maintenance expenses.
- The appropriate species of the evergreen plants should be used because these plants remain green all year,
- The plants should be planted so as to be perpendicular to the coming direction of the noise,
- The plants should be planted close to each other as far as possible and the gaps for each species should be suitable to growing conditions,
- Tall, big, tough-textured plants with rich leaves, branches and crown tissue extended to the ground should be used.
- The plants consisting of trees, shrubs and bushes in the different sizes should be used in forming the curtains,
- The short plants should be planted in the front, tall plants should be planted in the back. There is no gap between the plants as far as possible (The shrubs and coniferous species with a greater height than 5 m. prevent the noise better than others).
- The trees and shrubs curtains should be positioned in close proximity to the noise source.

As a result, the herbal application studies for the prevention of traffic noise are more economical than the non-living materials such as plastic sheets, concrete walls, etc., besides, it should be preferred to contribute to environmental aesthetics thanks to changing color and shape properties by seasons. In addition to block the noise, use of plant materials provides the reduction of the factors affecting ride comfort such as dust, wind, sun, etc. arising from the vehicles and environment. Therefore, it is necessary to spread the practices by using the herbal materials that have ecological, economic and aesthetic functions and are suitable for the area for solving the noise problem arising from the population growth accompanied by rapid urbanization in order to improve the livability of cities and urban health. Choosing the species of natural vegetation instead of exotic species is of great importance for ensuring the sustainability and reducing the maintenance costs.

## REFERENCES

- Aktas, Y., (2002). Kentiçi Alanlarda Bitki Kullanımı ile Gurultu Kontrolu (İstanbul, Maslak-Zincirlikuyu Hattı Orneğinde), İstanbul Üniversitesi Fen Bilimleri Enstitüsü, Peyzaj Mimarlığı Anabilim Dalı, Yüksek Lisans Tezi
- Alparslan, E., U. Erdem., (1987). Gurultu Sorunu: Peyzaj Mimarlığı Çalışmaları içinde Karayolları ile ilgili Örnekler. Çevre 87 Sempozyumu, İzmir.
- Anonymous 1999. The Turkish environmental legislation. The publication of Environment Foundation of Turkey. Publication no:134. Under printing, Ankara.
- Anonymous 2016. World Health Organization, Burden of Disease from Environmental Noise. Available at:<http://docs.wind-watch.org/WHOburden-of-disease-from-environmental-noise-2011.pdf> 2011. Accessed March. 4, 2016.
- Aylor DE, 1972. Noise reduction by vegetation and ground. J. Acoust. Soc. Am. 51, 197–205
- Bayraktar A., 1980, Karayollarının ekolojik baskılarının Peyzaj Mimarlığı açısından irdelenmesi ve İzmir-Ankara Karayolunda bir örnekleme üzerine araştırmalar, Ege Üniversitesi Ziraat Fakültesi, Yayın no: 423, İzmir
- Bernatzky, A.1978. Tree Ecology and Preservation. Elsevier Scientific Publishing Company. New York.
- Cepel, N., 1994. Landscape Ecology' I.U. Forest Faculty, Published No.429, 228, İstanbul
- Erdoğan, E., Yazgan, E., (2009). Landscaping in reducing traffic noise problem in cities: Ankara case. African Journal of Agricultural Research, 4(10): 1015-1022.
- Mutlu, Z., (2010). The Graduate School of Natural and Applied Science of Selçuk University the degree of Master Of Science of Landscape Architecture Thesis, A Research on Some Plant Which Will Be Used To Be Raised Difficulties About Traffic Noise Centrum of Konya.
- Onder, S., Kocbeker, Z., (2012). Importance of the Green Belts to Reduce Noise Pollution and Determination of Roadside Noise Reduction Effectiveness of Bushes in Konya, Turkey, International Journal of Biological, Biomolecular, Agricultural, Food, and Biotechnological Engineering, Vol:6, No:6, 2012
- Ozer, S., Irmak, M.Akif., Yilmaz, H., (2008). Determination of roadside noise reduction effectiveness of *Pinus sylvestris* L. and *Populus nigra* L in Erzurum, Turkey, Environmental Monitoring and Assessment, Volume 144, pp.191-197.
- Report, 1991. "Cost of Noise Reducing Devices. Department of Public Housing" Physical Planning and Environment. Netherland.
- Wilmers, F., 1990. Effects of vegetation on urban climate and buildings, Energy and Buildings, Vol. 15, Issues 3-4, pp:507-512

V International Conference  
„ECOLOGY OF URBAN AREAS“ 2016

**NOISE EMISSION WITHIN THE PLANT FOR PRIMARY  
PROCESSING AND STORAGE OF SCRAP METAL**

**Jelena Kiurski-Milošević<sup>1</sup>, Jovanić Dušan<sup>1</sup>, Danijela Jašin<sup>1</sup>, Gordana Ludajić<sup>1</sup>,  
Aleksandra Šučurović<sup>1</sup>**

<sup>1</sup>Technical college of applied sciences in Zrenjanin, Republic of Serbia  
jelena.kiurski@gmail.com

**ABSTRACT**

*Despite the fact that researches of the public and people at the workplace indicated that noise and vibration are factors that disturb the living conditions, work in the workspace and living environment, noise was not given adequate emphasis in assessment of pollution. European and world standards treat noise as one of the biggest polluters of working and living environment. Installations for the storage and primary processing of scrap metal are one of the major polluters of working environment in terms of noise. Their biggest problem in Serbia is that the majority of the aforementioned operators are located within the residential areas of cities. In the paper are performed measurements of noise emissions within the plant for primary processing and storage of scrap metal in the city of Zrenjanin. There were determined the dominant sources of noise on the metal scrapyards, where were conducted measurements. It will be displayed that all activities within the plant were carried out within the permissible limits of noise levels. Also, it will be specify measures for noise protection which should be undertaken in order to reduce the risk of this occurrence to a minimum and therefore to increase the security on a higher level.*

**Key words:** noise, scrap metal, storage, primary processing.

**INTRODUCTION**

Environmental noise is the accumulation of all noise present in a specified environment. The main sources of environmental noise are road, train and air traffic and industrial sources. These noise sources expose millions of people to noise pollution that creates not only annoyance, but also significant health consequences such as elevated incidence of hearing loss and cardiovascular disease. Exposure to noise at work can exacerbate stress and increase the risk of accidents to operators (Hammer et al., 2014).

Exceeded noise levels in urban areas have become very common. The one reason is the proximity of industrial plants to residential units and the other reason is that between the plant installations and housing units passes frequently road traffic. One of them is installations for the storage and primary processing of scrap metal.

The main and dominant noise sources on the scrapyards for metal waste “EKOMETAL-KOMERC DOO” in Zrenjanin come from operations of crushing and separation of metallic materials, shear for cutting scrap metal and equipment for internal transport. The plant is located at a periphery of the city of Zrenjanin, and is surrounded by industrial plants and groundfloor residential houses. Next to the plant passes the main road with high traffic.

**THEORY**

Sound is any mechanical wave, which represents the oscillation of particles of flexible environment with a frequency of 20 to 20.000 oscillations per second (Hz). Away from the source, sound oscillations transmitted acoustic energy. Acoustic oscillations in the air are manifested by modification of atmospheric pressure around the equilibrium position.

Induced changes in permanent atmospheric pressure are called the sound (acoustic) pressure. The reference sound pressure  $p_0=2 \cdot 10^{-5} \text{ Pa}=20 \mu\text{Pa}=0 \text{ dB}$  corresponds to the quietest sound at 1000 Hz that the human ear can detect. According to the Serbian standard for the measurement of noise in environment (SRPS U.J6.090:1992), the referent Sound Pressure Level  $L_p$  is given by (1):

$$L_p = 20 \log \frac{P}{P_0} \quad (1),$$

and it is measured in decibels (dB).

For control and assessment of noise levels it is necessary to choose appropriate measuring equipment. It is imperative that the measurement result possesses the property of repeatability. Basic characteristics of noise, which determine the selection of measuring equipment, are:

- Noise level;
- Time dependence of noise (continuous, variable, intermittent and impulsive noise);
- Frequency spectrum of noise (wideband, narrowband and tonal noise).

The basic components of the sound level meter are: condenser microphone, preamplifier, system for signal analysis (weight filters, band-pass filters and detector) and the display of the instrument which may be analog or digital. To allow the sound level meter to measure and report noise levels that represent what human ear can hear, frequency weightings are used. Based on the recommendations of the International Organization for Standardization (IEC-International Electro technical Commission) there are standardized three (or four) weighting curves or correction characteristics: "A", "B", "C", and "D" is not used (Figure 1).

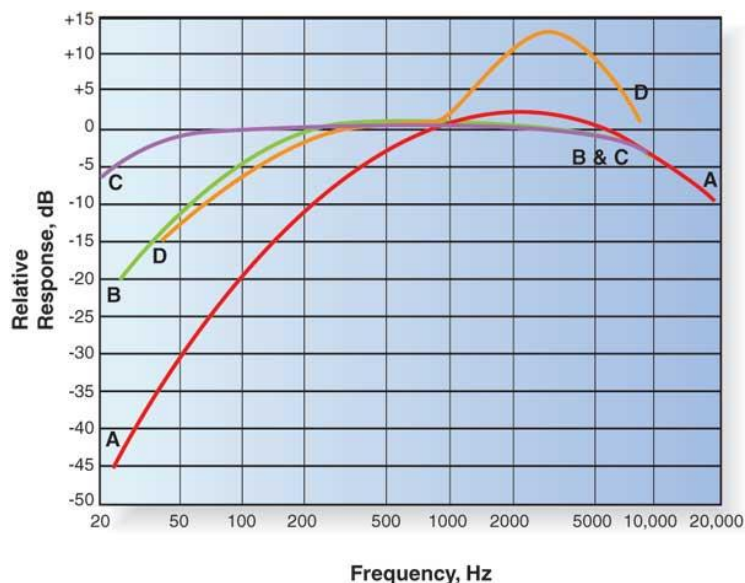

Figure 1. Weighting curves used in sound level meters

The concept of weighting refers to the relative shaping of the filter's response so as to mimic the ear at a given loudness level. Four weighted filter functions, A, B, C, and D, are used to simplify and apply regions of the loudness contours that are most meaningful for describing the frequency response of the human ear toward real world applications (Somers,2004). The A weighting curve corresponds to the constant loudness curve at approximately 20-40 phon, the B weighting curve is for the 50-70 phon range and the C weighting curve for 80-90 phon.

The time of weighting can be fast "F" 125 ms (corresponding approximately to the ear integration time), slow "S" with an exponential time constant of 1s, and impulse "I" which has a fast rise of 35 ms and slow decay.

However, in real conditions much more often is the case that the noise level fluctuates over a wide range with time (noise in the industry, communal noise, traffic noise). In order to assess the risk of such a noise, or compare the measured value with the permissible sound levels, it has been established the new term "equivalent sound level"  $L_{eq}$ , which represents: the sound pressure level in dB, equivalent to the total sound energy over a given period of time.

## METHODS

Equivalent Continuous Sound Level ( $L_{eq}$ ) is expressed by single number and is used to describe a phenomenon whose sound pressure level changes over time.  $L_{eq}$  is the sound pressure level of a steady sound that has, over a given period, the same energy as a fluctuating sound in question. It is expressed as:

$$L_{eq} = 10 \log \left( \frac{1}{N} \cdot \sum_{i=1}^N 10^{L_{pi}/10} \right) \quad (2)$$

$$N = \frac{t_2 - t_1}{\Delta t} \quad (3)$$

where:

$L_{eq}$  → equivalent continuous sound pressure level [dB]

$N$  → number of samples during sound signal

$L_{pi}$  → sound pressure level of the  $i$ -th sample [dB]

$t_2 - t_1$  → time interval between two samples [s]

$\Delta t$  → duration of the measurement [s].

For frequency analysis of acoustic signals mainly are used band-pass filters, ie. frequency band-pass filters built into the instrument for measuring the noise level. There are low-pass filters (pass low frequency), high-pass filters (pass high frequency) and filters that do not pass frequency. During frequency analysis or by passing the input signal through band-pass filters is obtained the noise level in individual octaves, thirds or in decibels.

“A” weighting curve aims to characterize the average healthy human ear and thus present a subjective impact of noise on humans. The mathematical formula defining the “A” weighting curve in the frequency domain is as follows in (4) and (5) (SRPS ISO 1996 – 1):

$$R_A(f) = \frac{12200^2 \cdot f^4}{(f^2 + 22.6^2) \cdot \sqrt{(f^2 + 107.7^2)(f^2 + 737.9^2)} \cdot (f^2 + 12200^2)} \quad (4)$$

$$A(f) = 2.0 + 20 \log [R_A(f)] \quad (5)$$

“A” weighted equivalent noise level ( $LA_{eq}$ ) is the basic parameter in analyzing the impact of noise on the living and working environment. It is calculated by summation of the impact of all difficult octaves, or thirds. Aggravation is done by adding the value of  $A(f)$  - (characteristic attenuation at the observed central frequency of the "A" weighting curve) to the measured noise level by octaves, ie. thirds. In that manner is obtained "A" - aggravated (weighted) noise level expressed in dB (A) at the observed third, or octave:

$$LA_{eq}(f) = L_{eq}(f) + A(f) \quad (6)$$

Equivalent noise level is then calculated:

$$LA_{eq} = 10 \log \left( \sum_{f=12.5\text{Hz}}^{20\text{kHz}} 10^{L_{eq}(f)+A(f)/10} \right), [\text{dB(A)}] \quad (7)$$

The N-percent exceeded level ( $L_N$ ) represents the sound level  $L$  which is exceeded in N% of measurement period, where N is between 0.01% and 99.99%. In other words, for N percent of the time, the fluctuating sound pressure levels are higher than the  $L_N$  level. The commonly used values of N for the N-percent exceeded level are 1,5,10, 50, 90, 95 and 99.

Sound exposure level (LAE) is used to categorize and quantify the noise generated by individual events for a specific time interval. It is calculated by (8):

$$LAE = 10 \log \left[ \frac{1}{t_2 - t_1} \int_{t_1}^{t_2} \frac{p_A^2(t)}{p_0^2} dt \right] \quad (8)$$

where:

$p_A(t)$  → the current value of the A-weighted sound pressure;

$t_2 - t_1$  → the observed time interval long enough to include all the significant noise from a given case;

$p_0$  → referent sound pressure (20  $\mu$ Pa);

$t_0$  → referent time (1s) (Bies & Hansen, 2009).

### Uncertainty of measurement

Uncertainty of measurement is expressed in accordance with the requirements of the standard SRPS ISO 1996-2 and represents the influence of error during the measurements by various factors (instrument or measuring chain, background noise, time of day in which measuring was done, meteorological conditions, etc.). Uncertainty of measurement is expressed by (9):

$$\sigma_t = \sqrt{1.0^2 + x^2 + y^2 + z^2}, [dB(A)] \quad (9)$$

where:

- uncertainty of 1.0 dB (A) – derived from the imperfection of the measuring chain Class 1 (in accordance with the standard IEC 61672-1: 2007) and represents a system error of measurement. If are used a Class 2 instruments in accordance with IEC 61672-1: 2002 or IEC 60651: 2001 / IEC 60804: 2000 Type 1 sound level meter, this value is higher;
- Parameter X – to be determined from at least 3, and preferably 5 measurements under repeatability conditions (the same measurement procedure, the same instruments, the same operator, the same place) and at a position where variations in meteorological conditions have little influence on the results. It is calculated as standard deviation. For long-term measurements more measurements will be required to determine the repeatability standard deviation.
- Parameter Y – the value will vary depending upon the measurement distance and the prevailing meteorology. A method using a simplified meteo window is provided in standard SRPS ISO 1996-2, Annex A. For long-term measurements different weather categories will have to be dealt with separately and then combined together. For short-term measurements during which there is no change of the weather conditions, this measurement uncertainty can be ignored. Also, when measuring basic (residual) noise level, whereby the position of the noise source is not specifically defined (noise comes from traffic and other noise sources in the vicinity of the metering point), this uncertainty can be ignored.
- Parameter Z – the value will vary depending on the difference between measured total values and the residual sound. The standard uncertainty due to residual sound, Z, can be calculated in accordance with (10):

$$Z = \sqrt{\sigma_s^2 - \sigma_0^2} \quad (10)$$

where:

$\sigma_s$  → the uncertainty for the specific sound level

$\sigma_0$  → the uncertainty for the overall sound levels (Manvell & Aflalo, 2005).

Expanded measurement uncertainty is calculated by:  $\pm 2\sigma_t$  [dB (A)] and provide a confidence level of 95%.



## Correction of measured values

The noise at the measuring point consists of noise from examined sound sources and background (residual) noise, traffic noise. According to the SRPS ISO 1996 – 2: “if the difference between the measured equivalent noise level from sound sources and the measured value of an equivalent level of background noise is in the range of 3 to 10 dB the correction is needed:

$$L_{\text{corr}} = 10 \log \left( 10^{\frac{L_{\text{meas}}}{10}} - 10^{\frac{L_{\text{resid}}}{10}} \right) \quad (11)$$

where:

$L_{\text{corr}}$  → corrected noise level of the sound source;

$L_{\text{meas}}$  → measured noise level of the sound source;

$L_{\text{resid}}$  → measured level of background (residual) noise.

Correction factor K is obtained by (12):

$$K = L_{\text{corr}} - L_{\text{meas}} \quad (12).$$

## FINDINGS

Experimental location where were conducted the measurement is located on the edge of residential area in the city of Zrenjanin at the industrial area. The primary activity of the observed company “EKOMETAL-KOMERC DOO” is collecting, primary processing, storage and transport of scrap metal. The dominant sources of noise at the examined location are: metal cutting machine – shredder, excavator and a truck with a hydraulic crane. The measurements were performed at the entrance of the plant, which is the closest point of the first residential houses (figure 2).



Figure 2. View of the experimental location

During the noise measurements at the measuring point, the impact of traffic noise was very expressive and encouraged by the truck traffic in industrial zone. Noise is wideband and variable. The microphone was located more than 3.5m away of the neighboring sound reflective surfaces at an altitude of 1, 5m. The measurement was done in intervals of 15 minutes with the time of sampling

0,125s (“Fast”) during the day at 10:30 to 12:30 h. During the measurements the air temperature was 28.1°C, air humidity was 46.2% and the wind speed has values from 0.2 m/s to 0.3 m/s. The measurement results were presented at the table 1.

Table 1: Results of the noise measurements

Acoustic characteristics of noise										
Time				Frequency						
Variable noise				Wideband noise						
During the “Slow” measurement, the noise level changes showed fluctuations exceeding 5 dBA and therefore noise was variable.				Spectral analysis showed that the distribution of the sound energy in several adjacent thirds was uniform.						
Measured parameters [dB(A)]										
Description of measurement			Equivalent level $L_{A,eq}$							
			measured level	correction factor	noise level	$\pm 2\sigma_t$				
Basic noise level			55.5	0	55.5	2				
Operating mode			62.0	-1.1	60.9	3.31				
Permissible level			65*							
Cumulative Distribution of noise levels [dB(A)]										
Description of measurement	LAE	LAF <sub>max</sub>	LAF <sub>min</sub>	L <sub>A,1</sub>	L <sub>A,5</sub>	L <sub>A,10</sub>	L <sub>A,50</sub>	L <sub>A,90</sub>	L <sub>A,95</sub>	L <sub>A,99</sub>
Basic noise level	83.73	75.22	36.09	66.35	61.78	58.79	48.16	40.84	39.7	38
Operating mode	91.64	82.89	52.15	72.09	66.52	63.55	58.97	56.84	56.14	53.86
Uncertainty of measurement										
	Instrument	X	Y	Z	$\sigma_t$		$\pm 2\sigma_t$			
Basic noise level	1 dB(A)	0	0	0	1 dB(A)		2 dB(A)			
Operating mode	1 dB(A)	0	0	1.32	1.66 dB(A)		3.31 dB(A)			

\* - According to the Regulations on permissible noise levels in the Environment

Summarized corrected results of measuring of noise level are presented in the following table 2.

Table 2: Corrected results of the noise measurement

Measuring point	Measured noise level of the sound source [dB(A)]	Measured level of background (residual) noise [dB(A)]	Corrected noise level of the sound source [dB(A)]	K [dB(A)]	Z [dB(A)]	Permissible level [dB(A)]
1	62.00	55.50	60.90	-1.10	1.32	65

## DISCUSSION

The goal of this research was to examine whether the experimental scrapyards have a negative impact on the near environment during operation. Based on the measurements of acoustic characteristics of noise, decisive noise levels of the surveyed sound sources at the measuring point in the daily period **does not exceed** the permissible limit value for communal area, at zone 5 in the city of Zrenjanin (Regulation on Methodology for Determination of Acoustic Areas) (center of the city, craft, commercial and administrative zone with dwellings, zone along highways, motorways and urban roads - permissible noise level for the day is 65 dB (A)).

It was found that typical changes in noise levels from examined scrapyard were in the range of 4 to 16 dB (A) above background noise levels. Background noise at the measuring point was mainly made up of road traffic, because near the examined plant passes the main road with high frequency.

In case of any significant increase in workloads or operated machinery at the “EKOMETAL-KOMERC DOO” Zrenjanin it leads to changes of noise impact to the nearby noise sensitive dwellings and other receptors. It may be necessary to reevaluate the noise impact and to do noise assessment again.

## CONCLUSIONS AND IMPLICATIONS

Noise pollution is often ignored because there are no visible effects. Metal scrapyards are places with disturbingly high levels of noise especially if they are located near residential areas. Citizens' complaints on this type of facilities are frequent all over the world.

Ambient noise measurements conducted in the city of Zrenjanin at the company “EKOMETAL-KOMERC DOO” showed that all operating activities within the plant were not exceeding the permissible limit. The noise impact was estimated by measurements of noise levels at the entrance of the experimental location, near the residential area.

The noise assessment conducted shows that the predicted noise levels close to the noise sensitive receptors are considered to be acceptable and unlikely to cause complaints. It is considered that the noise impact is acceptable and minimal.

If it comes to an increase of noise level on plants for primary processing and storage of scrap metal, it is possible to apply some techniques for its decrease by: setting a barriers and tunnels, installing a elastic bases below the machine equipment and changing materials for the coating of road surface.

## REFERENCES

- Bies A.D., & Hansen H.C. (2009). Engineering noise control. Theory and practice. Fourth edition, Taylor & Francis, New York, USA.
- Decree on noise indicators, thresholds, methods for marking noise indicators, harassment and the harmful effects of environmental noise (“Official Gazette of the Republic of Serbia”, No. 75/2010).
- Hammer, M.S., Swinburn, T.K., and Neitzel, R.L. Environmental noise pollution in the United States: developing an effective public health response. *Environ. Health Perspect.* 2014;122: 115–119.
- Manvell, D., & Aflalo, E. (2005). Uncertainties in environmental noise assessments – ISO 1996, effects of instrument class and residual sound. In Proceedings of the Forum Acusticum 2005, Budapest, Hungary.
- Regulation on the methodology for determination of acoustic areas (“Official Gazette of the Republic of Serbia”, No. 72/2010).
- Regulation on the methods for noise measurement, content and scope of the noise test report (“Official Gazette of the Republic of Serbia”, No. 72/2010).
- Regulations on the permissible noise levels in the Environment (“Official Gazette of the Republic of Serbia”, No. 54/92).
- Somers S. 2004. The Mysterious Loudness Control: What Does It Do?, *ExtronNews*, Issue 15.1, [http://www.extron.com/company/article.aspx?id=loudnesscontrol\\_ts](http://www.extron.com/company/article.aspx?id=loudnesscontrol_ts).
- SRPS ISO 1996-1:2010. Acoustics — Description, measurement and assessment of environmental noise. Part 1: Basic quantities and assessment procedures, Institute for Standardization of Serbia, Belgrade, Serbia.
- SRPS ISO 1996-2:2010. Acoustics – Description, assessment and measurement of environmental noise. Part 2: Determination of environmental noise levels, Institute for Standardization of Serbia, Belgrade, Serbia.
- SRPS U.J6.090:1992. Acoustics – Description and measurement of environmental noise, Institute for Standardization of Serbia, Belgrade, Serbia.

V International Conference  
„ECOLOGY OF URBAN AREAS“ 2016

## EXPOSURE TO WHOLE-BODY VIBRATION, TOOLS FOR CALCULATING DAILY EXPOSURES AND MEASUREMENT

Vladimir Šinik<sup>1</sup>, Željko Despotović<sup>2</sup>, Slobodan Janković<sup>1</sup>

<sup>1</sup>University of Novi Sad, Technical faculty "Mihajlo Pupin" Zrenjanin, Serbia,

<sup>2</sup>Institute —Mihajlo Pupin, Belgrade, Serbia

sinik.vladimir@gmail.com

### ABSTRACT

*In this paper we will discuss about undesirable human vibrations and the effect of over-exposure to human vibration. Very important what can be taken to reduce harmful and/or dangerous sources of vibration. The tools for calculating daily exposures are give: daily exposure graph, daily exposure nomogram, exposure points system. On the end is to give protocol for whole-body vibration (wbv) measurements.*

### INTRODUCTION

Human vibration is defined as the effect of mechanical vibration on the human body. During our normal daily lives we are exposed to vibrations of one or other sort e.g. in buses, trains and cars. Many people are also exposed to other vibrations during their working day, for example vibrations produced by hand-tools, machinery, or heavy vehicles. Just as sound can be either music to the ear or irritating noise, human vibrations can either be pleasant or unpleasant [1]. We enjoy, and even create pleasant vibrations when we run, dance or take a trip on the merry-go-round, but we try to avoid exposing ourselves to unpleasant vibrations such as travelling on a bumpy road or operating hand-held power tools. A good deal of research has been done in studying the effect of exposure to vibration on man, especially in his working environment. Some of the early research involved a study of people such as aircraft pilots, operators of heavy work vehicles and hand-tool operators. Their ability to perform complex tasks under adverse vibrational conditions formed part of the first investigations. Nowadays, human vibration research is also carried out in working environments and the results used to establish International Standards which allow human exposure to vibration to be evaluated. In this paper we will only discuss undesirable human vibrations: the effect of over-exposure to human vibration; the various factors which have to be taken into consideration when it is measured; how it is measured and evaluated, and what action can be taken to reduce harmful and/or dangerous sources of vibration [1].

Regular exposure to Whole-Body Vibration (WBV) can in some cases be responsible for reducing operator comfort, performance and health. Defining any such health effects is difficult as many symptoms are indistinguishable from other causes. Long term exposure to whole-body vibration (WBV) particularly to repeated large jolts and jars are however linked to back pain. Employees who operate mobile machines or other vehicles over poor surfaces as a main part of their job are particularly at risk. If employees are at risk, employers and equipment manufacturers must consider what action is needed to reduce the risk so far as is reasonably practicable. This must meet the requirements of general legislation including the Health and Safety at Work etc Act 1974, the Management of Health and Safety at Work Regulations and the Control of Vibration Regulations 2005 [3]

### EXPOSURE TO WHOLE-BODY VIBRATION

Exposure to whole-body vibration can either cause permanent physical damage, or disturb the nervous system. Daily exposure to whole-body vibration over a number of years can result in serious physical



*Fig.1. Jobs which causing whole body vibration*

damage, for example, ischemic lumbago. This is a condition affecting the lower spinal region. Exposure can also affect the exposed person's circulatory and/or urological systems. People suffering from the effect of long-term exposure to whole-body vibration have usually been exposed to this damaging vibration in association with some particular task at work. Exposure to whole-body vibration can disturb the central nervous system. Symptoms of this disturbance usually appear during, or shortly after, exposure in the form of fatigue, insomnia, headache and "shakiness". Many people have experienced these nervous symptoms after they have completed a long car trip or boat trip. However, the symptoms usually disappear after a period of rest [1]. Regular operators and drivers of off-road machinery are likely to experience high vibration exposures. Examples are listed below: (They will not always cause injury because the risk also depends on the time spent driving, road conditions, the age of the person, if there are previous back or neck problems and indeed if the person is pregnant) [5].

- Construction, mining and quarrying machines and vehicles, particularly earth-moving machines snow ploughs, bulldozers, planers, site dumper trucks and vibrating rollers.
- Tractors and other grass cutting and forestry machinery, particularly when used in transit between areas, tedding (turning hay), primary cultivation.
- Vehicles designed for smooth surfaces driven on poor surfaces e.g. lift trucks with no wheel suspension or with solid tyres used on a cracked or uneven yard (Fig. 1).
- Small fast boats.
- Unsuitable machines or vehicles for the task.
- Using poor operating or driving techniques e.g. driving too fast or operating the machine too aggressively.
- Roadways or work areas that are potholed cracked or covered in rubble.
- Road-going vehicles that are regularly driven off-road or over poorly-paved surfaces for which they are not suitable[5].

The effects of vibration are therefore complex. Exposure to whole-body vibration causes motions and forces within the human body that may:

- cause discomfort,
- adversely affect performance.
- aggravate pre-existing back injuries, and
- present a health and safety risk[2].

“Low-frequency vibration of the body can cause motion sickness. “Epidemiological studies of long-term exposure to whole-body vibration have shown evidence for an elevated risk to health, mainly in the lumbar spine but also in the neck and shoulder. Some studies have reported evidence of effects on the digestive system, the female reproductive organs and the peripheral veins.”

According to the ISO 2631-1 guidelines on Mechanical vibration and shock – Evaluation of human exposure to whole-body vibration:

“The relevant literature on the effects of long-term high-intensity whole-body vibration indicates an increased health risk to the lumbar spine and the connected nervous system of the segments affected. This may be due to the biodynamic behaviour of the spine: horizontal displacement and torsion of the segments of the vertebral column. Excessive mechanical stress and/or disturbances of nutrition of and diffusion to the disc tissue may contribute to degenerative processes in the lumbar segments (spondylosis deformans, osteochondrosis intervertebralis, arthrosis deformans).

All types of vehicle, when in motion, are likely to cause the driver to experience whole-body vibration. The risks to health increase where people are regularly exposed to high levels of whole-body vibration over a long period. Some vehicles that have been associated with whole-body vibration and ergonomic risks are shown in Fig.2. Remember that whole-body vibration exposure may also arise from non-driving activities, e.g. where workers stand on vibrating platforms [3].

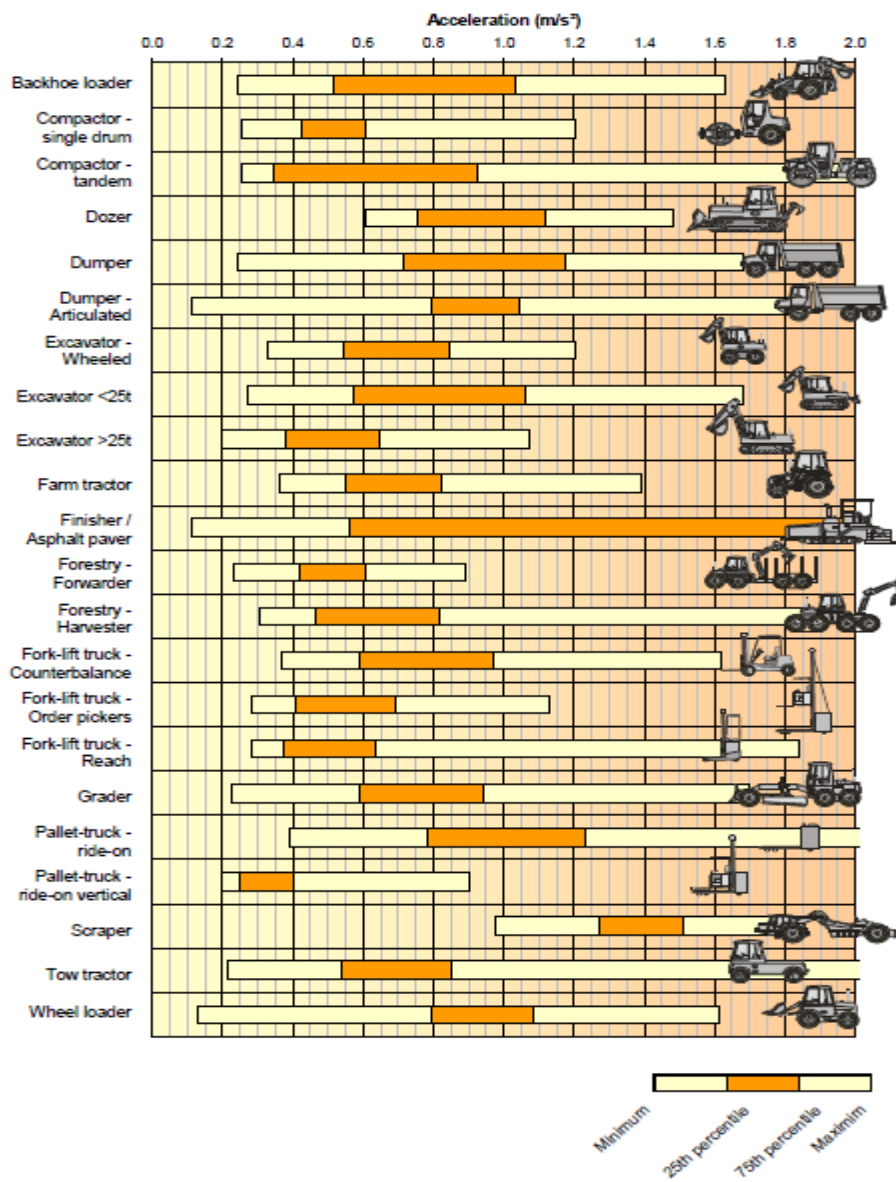

Fig. 2 Examples of vibration magnitudes for common tools[3]

## TOOLS FOR CALCULATING DAILY EXPOSURES

### Daily exposure graph

The graph in Fig.3 gives a simple alternative method for looking up daily exposures or partial vibration exposures without the need for a calculator.

Simply look on the graph for the A(8) line at or just above where your vibration magnitude value  $(ka_w)_{max}$  and exposure time lines meet (the factor  $k$  is either 1.4 for the x- and y-axes or 1.0 for the z-axis i.e. vertical direction).

The green area in Fig. 3 indicates exposures likely to be below the exposure action value. These exposures must not be assumed to be “safe”. There may be a risk of whole-body vibration injury for exposures below the exposure action value, and so some exposures within the green area may cause vibration injury in some workers, especially after many years of exposure[3].

### Daily exposure nomogram

The nomogram in Fig.4 provides a simple alternative method of obtaining daily vibration exposures, without using the equations:

- (a) On the left hand line find the point corresponding to the vibration magnitude (use the left scale for x- and y-axis values; the right scale for z-axis values).
- (b) Draw a line from the point on the left hand line (representing the vibration magnitude) to a point on the right hand line (representing the exposure time);

Read off the partial exposures where the line crosses the central scale[3].

### Exposure points system

Whole-body vibration exposure management can be simplified by using an exposure “points” system. For any vehicle or machine operated, the number of exposure points accumulated in an hour ( $PE, 1h$  in points per hour) can be obtained from the vibration magnitude  $a_w$  in  $m/s^2$  and the factor  $k$  (either 1.4 for x- and y-axes or 1.0 for the z-axis) using:

$$P_{E,1h} = 50(ka_w)^2$$

Exposure points are simply added together, so you can set a maximum number of exposure points for any person in one day.

The exposure scores corresponding to the exposure action and limit values are:

- exposure action value ( $0.5 m/s^2$ ) = 100 points;
- exposure limit value ( $1.15 m/s^2$ ) = 529 points.

In general the number of exposure points,  $P_E$  is defined by:

$$P_E = \left( \frac{ka_w}{0.5 m/s^2} \right)^2 \frac{T}{8hours} 100$$

Where  $a_w$  is the vibration magnitude in  $m/s^2$ ,  $T$  is the exposure time in hours and  $k$  is the multiplying factor of either 1.4 for x-and y-axes or 1.0 for the z-axes.

Alternatively Fig. 5 gives a simple method for looking up the exposure points

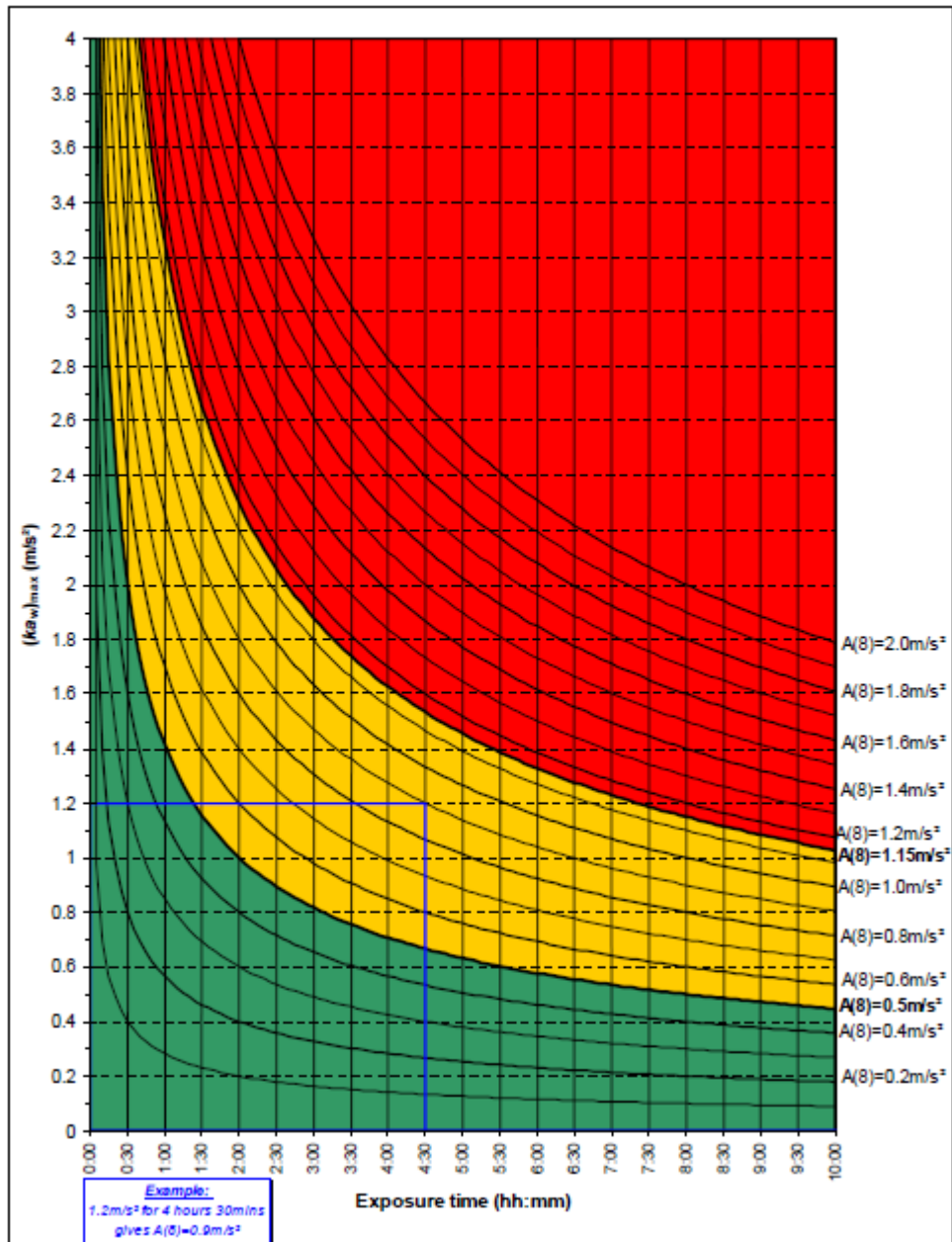

Fig. 3 Daily exposure graph[3]

The daily exposure  $A(8)$  can be calculated from the exposure point using:

$$A(8) = 0.5 \text{ m/s}^2 \sqrt{\frac{P_E}{100}}$$



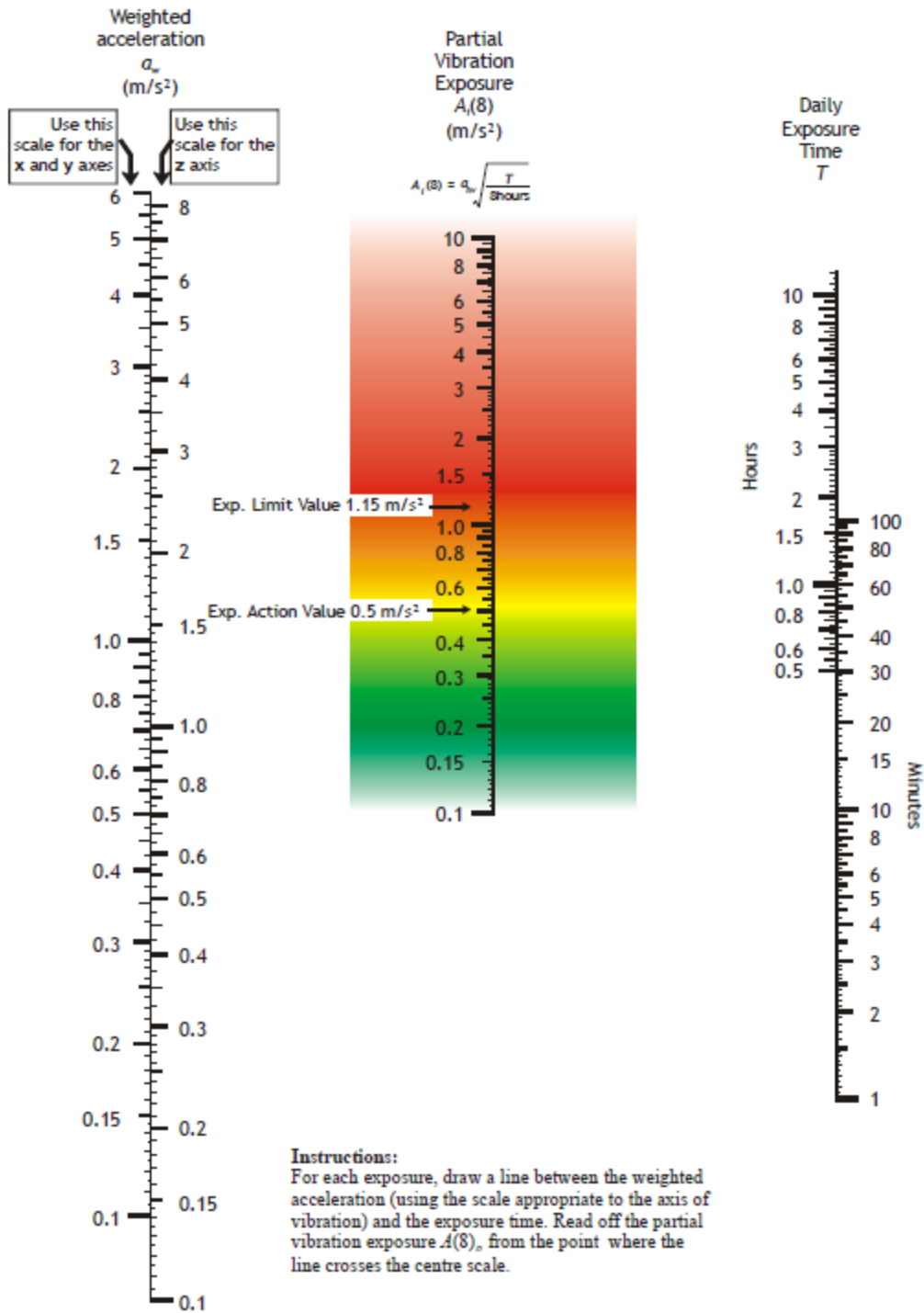

Fig. 4 Nomogram for  $A(8)$  values[3]

Acceleration $\times k$ (m/s <sup>2</sup> )	2	50	100	200	400	600	800	1000	1200	1600	2000	2400
	1.9	45	90	180	360	540	720	905	1100	1450	1800	2150
	1.8	41	81	160	325	485	650	810	970	1300	1600	1950
	1.7	36	72	145	290	435	580	725	865	1150	1450	1750
	1.6	32	64	130	255	385	510	640	770	1000	1300	1550
	1.5	28	56	115	225	340	450	565	675	900	1150	1350
	1.4	25	49	98	195	295	390	490	590	785	980	1200
	1.3	21	42	85	170	255	340	425	505	675	845	1000
	1.2	18	36	72	145	215	290	360	430	575	720	865
	1.1	15	30	61	120	180	240	305	365	485	605	725
	1	13	25	50	100	150	200	250	300	400	500	600
	0.9	10	20	41	81	120	160	205	245	325	405	485
	0.8	8	16	32	64	96	130	160	190	255	320	385
0.7	6	12	25	49	74	98	125	145	195	245	295	
0.6	5	9	18	36	54	72	90	110	145	180	215	
0.5	3	6	13	25	38	50	63	75	100	125	150	
0.4	2	4	8	16	24	32	40	48	64	80	96	
0.3	1	2	5	9	14	18	23	27	36	45	54	
0.2	1	1	2	4	6	8	10	12	16	20	24	
		15m	30m	1h	2h	3h	4h	5h	6h	8h	10h	12h
		Daily Exposure time										

Fig. 5 Exposure points table (rounded values)[3]

**A VIBRATION MEASUREMENT SYSTEM**

In many situations it will not be necessary to measure vibration magnitudes. However, it is important to know when to conduct measurements. For WBV the axis with the highest average root mean square acceleration is used to calculate the daily vibration exposure A(8). Fig. 6 shows the standard orientation of the x, y, and z axes. The measurements taken on the x and y axes are given a weighting of 1.4 times the measured value to reflect their contribution to health effects. This is different from hand-arm vibration assessment in which the vibration measurement is the triaxial sum of the acceleration experienced by the worker in the three axes.

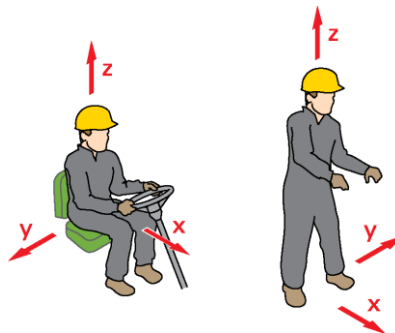

Fig. 6 Vibration measurement axes in both seated and standing positions

## **Protocol for whole-body vibration (wbv) measurements**

### **1. Measuring equipment**

Vibrations are measured by using an equipment able to provide the effective value (r.m.s. value) of the acceleration of the surface that comes in contact with the user's body. Equipment shall be compliant to the Standard ISO 8041. Therefore, the equipment must be made, besides the accelerometers, by:

a) a spectrum analyser (minimum three channels) without the recording chain. This method presents the advantage of an immediate reading of the acquired spectra, but does not allow the subsequent processing of the signals acquired by analysis modes that are different from those used in the acquisition phase; or:

b) a measurement signal recorder (minimum three channels). The signal is then analysed by a spectrum analyser. The recorder shall necessarily be equipped with a overload gauge, in order to prevent distortions in the recorded signal. Therefore, for the purposes of quality control of measurement, the spectral analysis of measurements, in thirds of octave, is required[4].

### **2. Specifications for the measurement**

The specifications of the accelerometer commonly used for whole-body vibration measurements and of its adapter are reported in the Standard ISO 10326-1. The measurements shall be compliant with the Standard ISO 2631-1. In the case of measurements carried out at the driving position, the signal on the vehicle floor shall be acquired in addition and simultaneously to that measured on the seat, at least along the Z axis, in order to verify the presence of any peaks due not to the vibration transmitted by the vehicle but to movements of the operator on the seat. This condition is confirmed by the presence, in the signal detected on the seat, of peaks that are absent in the signal detected on the vehicle floor in the same measurement time series. The signal associated with the duration of such events may need to be excluded from the determination of the r.m.s. values of acceleration detected on the seat along the three axes of measurement. The signal on the vehicle floor can be acquired by rigidly fastening on the floor, in the immediate proximity of the seat, preferably on the metallic structure at the base of the seat, an uniaxial or triaxial accelerometer displaying features similar to those of the accelerometer mounted on the seat. For the measurements in the upright position, the value on the vehicle floor shall be measured; if there is a shock absorbing structure on which the worker stands, it is necessary to measure the vibration both on this structure and on the vehicle floor itself[4].

### **3. Duration of measurement**

The total measurement time, i.e. the number of acquired samples multiplied by the duration of the acquisition of each sample, should last at least three to four minutes. The measurements should be of such duration as to be able to significantly characterize the vibration transmitted to the worker's whole-body in the typical operating conditions in which the work is carried out (quality of the ground, forward speed, working task, load characteristics, etc.). In the event that the operating conditions vary significantly, different tracks in different operating modes shall be characterized in terms of r.m.s. frequency-weighted acceleration. In order to check the quality of the data measured on the seat and to exclude interfering events, it is necessary to record the time history of the signal that has been simultaneously detected on the cushion and on the vehicle floor, with a sampling frequency of at least 1 sample per second. The curve of these signals should be attached to the measurement report[4].

### **4. Assessment of uncertainty**

The uncertainty factors that follow shall be assessed; the person responsible for the measurement shall determine, in each specific case, the main sources of uncertainty, and, in accordance to that, increase the number of acceleration measurements in order to quantify, by calculating the standard deviation, the extent of the error associated with the main indetermination factors.

The measuring equipment and the related calibrator must undergo calibration at an accredited calibration laboratory (national or EA center) at least every two years.

a. Biases due to the acquisition system (weight, location and mounting of accelerometers, electrical interferences, calibration). These measurement errors can be minimized by selecting an appropriate measurement technique. In this case the measurement error associated with this component is  $< 4\%$ .

b. Errors due to random fluctuations of the concerned physical parameters (temperature, humidity, stability of the machine power supply, homogeneity of the ground where the machine went to, etc.). These errors can be minimized by increasing statistics of the samples. The estimate of the random

measurement error is obtained by the standard deviation of at least three measurements performed under identical experimental conditions.

c. Changes in the ways of driving of different operators and in the different anthropometric characteristics that affect the level of vibration detected on the seat: this factor shall be taken into account for the purposes of the inclusion of the data in VBD as the exposure is assessed for homogeneous working tasks and not for the individual worker. In this case the measurements shall be repeated in the same operating conditions, with at least two operators displaying different anthropometric characteristics and/or professional experience.

d. Changes in the maintenance and adjustment conditions of the machine (e.g., conditions of the shock absorbers, seat adjustment etc.): the measurements shall be carried out on machines that have undamaged seats, that regularly undergo maintenance and that are correctly adjusted for the weight of the driver.

e. Changes in the characteristics of the quality of the ground on which the vehicle is used (asphalt, mixed ground, presence of potholes or rocks etc.). These characteristics shall be specified in the data collection form[4].

## CONCLUSION

Work that involves exposure to whole-body vibration occurs commonly in off-road work, such as farming, construction and quarrying, but it can occur elsewhere, for example on the road in lorries and trucks, at sea in small fast boats and in the air in some helicopters. Whole-body vibration is not restricted to seated workers such as drivers, but may also be experienced during standing operations such as standing on a concrete crushing machine. The purpose of the whole-body vibration risk assessment is to enable you as the employer to make a valid decision about the measures necessary to prevent or adequately control the exposure of workers to whole-body vibration.

## REFERENCES

- [1] <http://www.bksv.com/doc/br056.pdf>
  - [2] [www.vibeforhealth.com/Data/Default/the\\_effect\\_of\\_wbv\\_negative.pdf](http://www.vibeforhealth.com/Data/Default/the_effect_of_wbv_negative.pdf)
  - [3] [http://resource.isvr.soton.ac.uk/HRV/VIBGUIDE/2008\\_11\\_08%20WBV\\_Good\\_practice\\_Guide%20v6.7h%20English.pdf](http://resource.isvr.soton.ac.uk/HRV/VIBGUIDE/2008_11_08%20WBV_Good_practice_Guide%20v6.7h%20English.pdf)
  - [4] [http://www.portaleagentifisici.it/filemanager/userfiles/PROTOCOLLI/Vibrazioni\\_wbv\\_da\\_misuratore\\_EN.pdf?lg=EN](http://www.portaleagentifisici.it/filemanager/userfiles/PROTOCOLLI/Vibrazioni_wbv_da_misuratore_EN.pdf?lg=EN)
  - [5] <http://www.westlothian.gov.uk/media/1840/Whole-Body-Vibration-Procedure/pdf/whole-body-vibration-proced.pdf>
- Council Directive 90/269/EEC of 29 May 1990 *on the minimum health and safety requirements for the manual handling of loads where there is a risk particularly of back injury to workers (fourth individual Directive within the meaning of Article 16(1) of Directive 89/391/EEC)*
- Directive 2002/44/EC of the European parliament and of the Council of 25 June 2002 *on the minimum health and safety requirements regarding the exposure of workers to the risks arising from physical agents (vibration) (sixteenth individual Directive within the meaning of Article 16(1) of Directive 89/391/EEC)*
- Directive of 89/391/EEC of the European parliament and of the Council of 12 June 1989 *on the introduction of measures to encourage improvements in the safety and health of workers at work.*
- EN 14253, Mechanical vibration — Measurement and calculation of occupational exposure to whole-body vibration with reference to health — Practical guidance
- EN 1032:2003 Mechanical vibration — Testing of mobile machinery in order to determine the vibration emission value
- EN 12096:1997 Mechanical vibration — Declaration and verification of vibration emission values.
- CEN/TR First committee draft Munich (March 2005) — Mechanical vibration - Guideline for the assessment of exposure to whole-body vibration of ride on operated earth-moving machines. Using harmonised data measured by international institutes, organisations and manufacturers.
- CEN/TR 15172-1, Whole-body vibration – Guidelines for vibration hazards reduction – Part 1: Engineering methods by design of machinery.
- CEN/TR 15172-2, Whole-body vibration – Guidelines for vibration hazards reduction – Part 2: Management measures at the workplace.

V International Conference  
„ECOLOGY OF URBAN AREAS“ 2016

**HEALTH SURVEILLANCE , HEALTH RISKS, SIGNS AND  
SYMPTOMS FOR HAND-ARM VIBRATION**

**Vladimir Šinik<sup>1</sup>, Slobodan Janković<sup>1</sup>, Željko Despotović<sup>2</sup>**

<sup>1</sup>University of Novi Sad, Technical faculty "Mihajlo Pupin" Zrenjanin, Serbia,

<sup>2</sup>Institute —Mihajlo Pupin, Belgrade, Serbia

sinik.vladimir@gmail.com

**ABSTRACT**

*The paper was presented what is health surveillance, what recording is required and what to do if injury is identified in the case of hand-arm vibration. Health surveillance is about putting in place systematic, regular and appropriate procedures for the detection of work-related ill health, and acting on the results. The aims are primarily to safeguard the health of workers but also to check the long-term effectiveness of control measures.*

**INTRODUCTION**

Health surveillance is about having procedures to detect work-related ill health at an early stage and acting on the results. The main aims are to safeguard the health of employees (including identifying and protecting people at increased risk), and also to check the long-term effectiveness of control measures. In the case of hand-arm vibration, one of the specific aims is to prevent employees developing an advanced stage of hand-arm vibration syndrome (HAVS) associated with disabling loss of hand function. It is possible that your employees who are exposed to vibration may have mild symptoms of HAVS. If they are not aware that they have the disease, health surveillance can help them to recognise that the first symptoms of HAVS have started to develop [1]. Member States shall adopt provisions to ensure the appropriate health surveillance of workers where the hand-arm vibration risk assessment indicates a risk to their health.

The provision of health surveillance, including the requirements specified for health records and their availability, shall be introduced in accordance with national laws and/or practice [2].

**HEALTH EFFECTS OF HAV EXPOSURE**

Workers exposed regularly to excessive hand-arm-transmitted vibration may be suffer in the long term with disturbances to finger blood flow and to the neurological and locomotor functions of the hand and arm. The term *hand-arm vibration syndrome* is used to refer to these complex disorders.

Hand-arm vibration syndrome has an impact on social and family life. Periodic attacks of impaired blood circulation will take place not only at work, but also during activities such as car washing or watching outdoor sports. Everyday tasks, for example managing small buttons on clothes may become difficult.

Vascular disorders, neurological disorders and bone and joints abnormalities caused by hand-transmitted-arm vibration are recognized occupational diseases in several European countries [2].

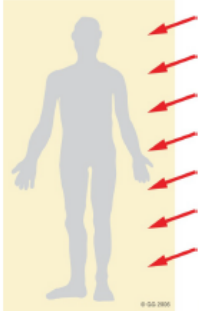
	<p>Health hazards:</p> <ul style="list-style-type: none"><li>• Hand-arm vibration syndrome</li><li>• Vibration-related upper extremity disorders</li><li>• Work-related musculoskeletal disorders</li><li>• Stress-related health effects</li><li>• Noise-related hearing loss</li><li>• Dust-related lung disorders</li><li>• Vapour-related skin or mucous disorders.</li></ul>
---	---

### Vascular disorders

Workers exposed to hand-transmitted-arm vibration may complain of episodes of whitening (blanching) of the fingers (Vibration white fingers “VWF), usually triggered by cold exposure (Fig.1). This symptom is caused by temporary closing down of blood circulation to the fingers.

Various terms have been used to describe vibration-induced vascular disorders:

- dead or white finger,
- Raynaud's phenomenon of occupational origin,
- vibration-induced white finger

Initially attacks of blanching involve the tips of one or more fingers, but, with continued exposure to vibration, the blanching can extend to the base of the fingers. As the blood flow returns to the fingers (this is commonly initiated by warmth or local massage) the fingers turn red, and are often painful. The blanching attacks are more common in winter than in summer. The duration varies with the intensity of the vibration stimuli from a few minutes to more than one hour.

If vibration exposure continues, the blanching attacks become more frequent affecting more of the fingers. The attacks may occur all year around with quite small reductions of temperature. During a blanching attack the affected worker can experience a complete loss of touch sensation and manipulative dexterity, which can interfere with work activity increasing the risk for acute injuries due to accidents[2].

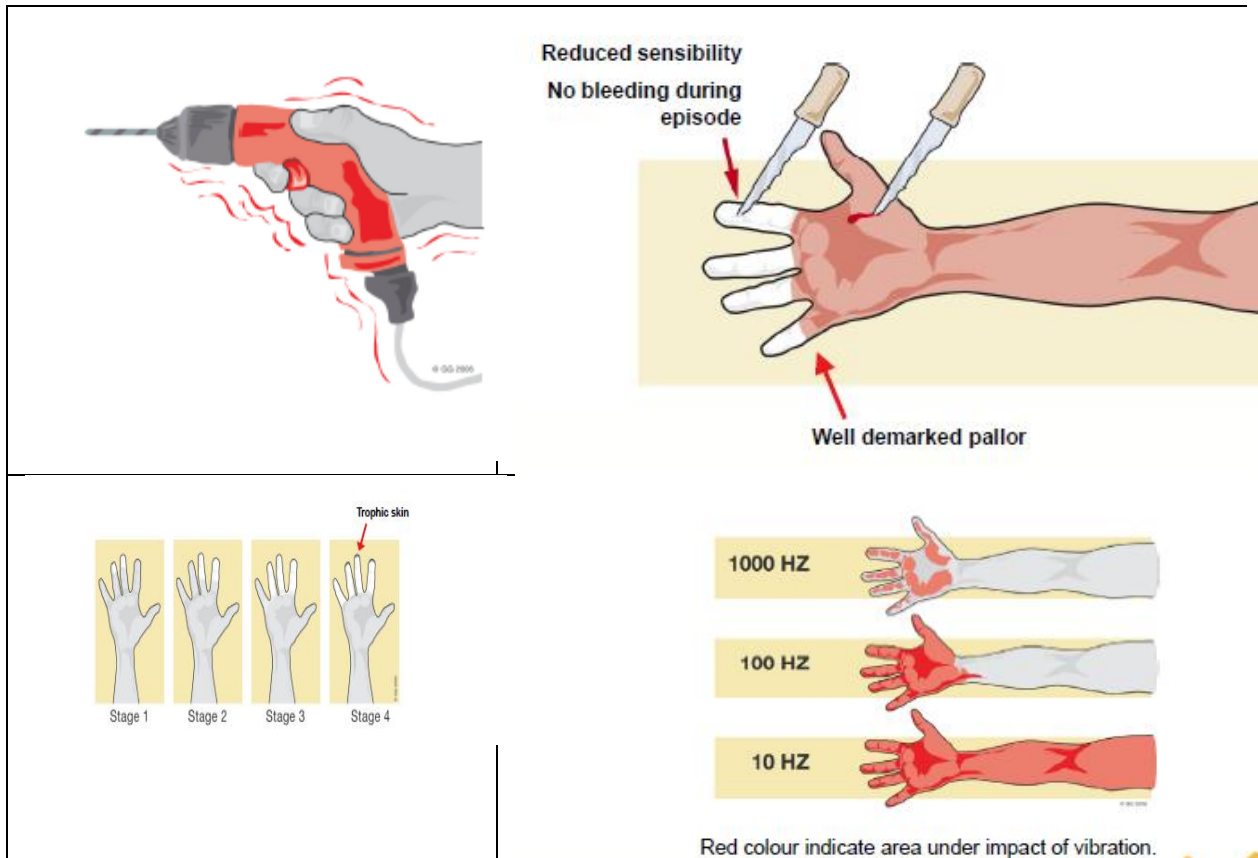

Fig. 1. Events of vascular disorders[3]

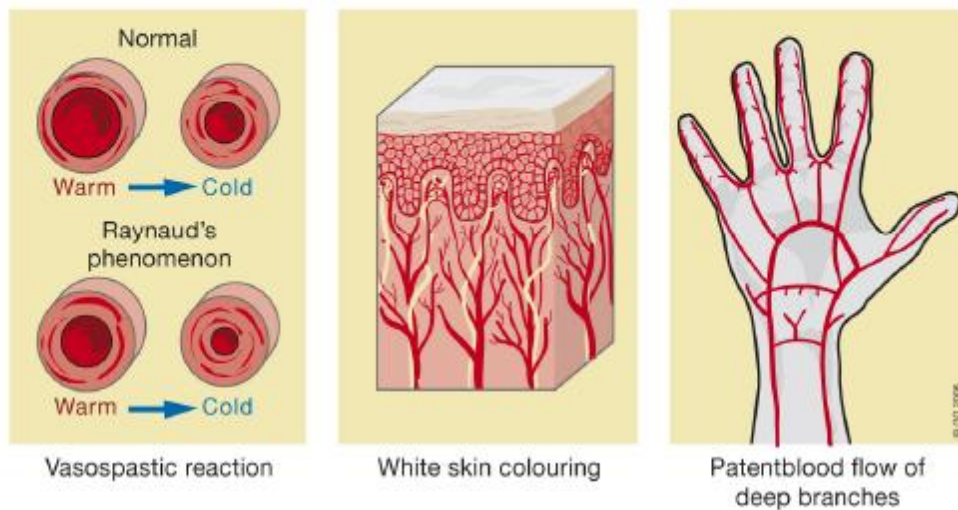

Fig. 2. Vascular system of the upper extremity[3]

Epidemiological studies have demonstrated that the probability and severity of blanching is influenced by the characteristics of vibration exposure and duration of exposure, the type of tool and work process, the environmental conditions (temperature, air flow, humidity, noise), some biodynamic and ergonomic factors (grip force, push force, arm position), and various individual characteristics (individual susceptibility, diseases and agents such as smoking and certain medicines that affect peripheral circulation)(Fig .3.)



Fig.3 Some various individual characteristics effect on the vibration[3]

### Neurological disorders

Workers exposed to hand-transmitted arm vibration may experience tingling and numbness in their fingers and hands. If vibration exposure continues, these symptoms tend to worsen and can interfere with work capacity and life activities. Vibrationexposed workers may exhibit a reduction in the normal sense of touch and temperature as well as an impairment of manual dexterity [2].

Effects on human performance(some problem)

- The motor control problem - vibration may make it difficult to maintain control over the instrument or tool being used.
- The tactile problem - both short and long term exposure to hand-arm vibration may cause a loss of sensitivity in the fingers and hand.

The motor control problem

- The proprioceptive system conveys information about the joint angles. The brain calculates the position in space of the hand or arm.
- The kinaesthetic system conveys a sense of motion of the limbs to the brain. This information is necessary for the brain to coordinate motion.

Because most tasks become more difficult to complete the worker has to devote more mental effort to the task, which in turn:

- Increases the likelihood of accidents and injuries
- Decreases the comfort level experienced by the worker
- Mental fatigue reduces the amount of time that worker can continue to work in such an environment.

Combating the motor control problem

- Avoid or minimize exposure
- Isolate or dampen the vibration
  - Machine side - Changes can be made to the tool or instrument, e.g. adding better grip to tool
  - User side - These interventions can include teaching workers better grips and working positions.
- Training can improve performance on almost any motor skill.
- Accuracy in a skilled motor task can be improved by increasing the amount time available to complete the task.

The tactile problem

- The result of prolonged exposure and are most problematic in fine motor activity.
- Typically, tactile problems are most obvious directly after exposure.
- The loss of sensitivity in the fingers makes it more difficult to make judgments of texture, weight and form of the objects being handled.
- In extreme cases, permanent damage may occur and sensitivity will never return.

Combating the tactile problem

- Eliminating or minimize the exposure
- Ensure proper recovery times.
- Complete as many fine motor movements as possible before using power tools.
- Looking directly at the hands while performing a task can compensate for some sensitivity loss [3].



## Carpal-tunnel syndrome

Epidemiological research in workers has also shown that use of vibrating tools in combination with repetitive movements, forceful gripping, awkward postures may increase the risk of carpal tunnel syndrome [2].

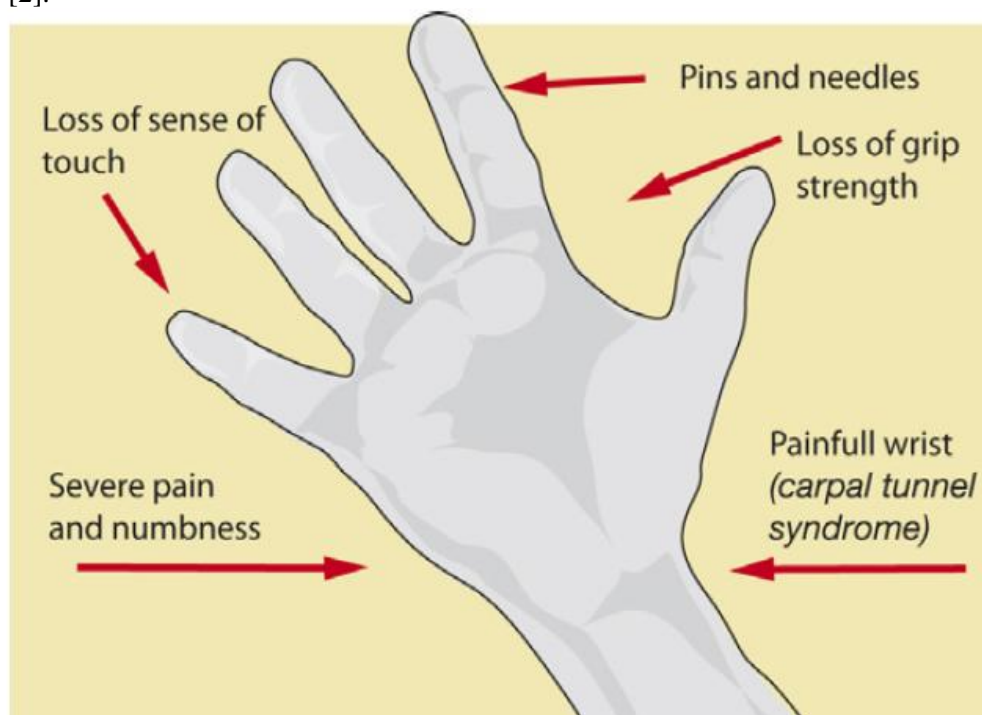

Fig.4. Carpal tunnel syndrome and other effects[2]

## Musculoskeletal disorders

Workers with prolonged exposure to vibration may complain of muscular weakness, pain in the hands and arms, and diminished muscle strength. These disorders seem to be related to ergonomic stress factors arising from heavy manual work. Excess occurrence of wrist and elbow osteoarthritis as well as hardening of soft tissue (ossification) at the sites of tendon attachment, mostly at the elbow, have been found in miners, road construction workers and metal-working operators of percussive tools. Other work-related disorders have been reported in vibration-exposed workers, such as inflammation of tendons (tendonitis) and their sheaths in the upper limbs, and Dupuytren's contracture, a disease of the fascial tissues of the palm of the hand [2].

## HEALTH SURVEILLANCE TECHNIQUES

Health surveillance is about having procedures to detect work-related ill health at an early stage and acting on the results. The main aims are to safeguard the health of employees (including identifying and protecting people at increased risk), and also to check the long-term effectiveness of control measures. In the case of hand-arm vibration, one of the specific aims is to prevent employees developing an advanced stage of hand-arm vibration syndrome (HAVS) associated with disabling loss of hand function. It is possible that your employees who are exposed to vibration may have mild symptoms of HAVS. If they are not aware that they have the disease, healthsurveillance can help them to recognise that the first symptoms of HAVS have started to develop [1].

### When is health surveillance required?

Health surveillance should be provided for vibration-exposed employees who:

- are likely to be regularly exposed above the action value of  $2.5 \text{ m/s}^2 \text{ A}(8)$ ;

- are likely to be exposed occasionally above the action value and where the risk assessment identifies that the frequency and severity of exposure may pose a risk to health; or
- have a diagnosis of HAVS (even when exposed below the action value).

If you are self-employed there is no legal requirement for you to have health surveillance for HAVS. However, it is important for your well-being, and for your ability to remain in work, that you identify any early signs of HAVS and take appropriate action. It is therefore recommended that you follow this guidance if you think you are at risk from vibration [1].

### **What do I actually have to do?**

You need to ensure that you achieve an effective health surveillance programme in the workplace, including co-operation from employees. When you plan to introduce health surveillance, explain to your employees and their safety or employee representatives what you are proposing to do and give them the opportunity to comment on your proposals. Employees need to be given information about the reasons for carrying out health surveillance and they need to understand their roles and responsibilities.

### **What do I need to do about the results of health surveillance?**

You need to make a decision about an individual employee if the doctor advises you that they are not fit for work with exposure to vibration. The employee is at risk of developing disabling loss of hand function if exposure is allowed to continue. You should consider assigning the employee to alternative work where there is no risk from further exposure to vibration. If you are informed that an employee has been diagnosed with HAVS but is still fit for work with exposure to vibration, it is good practice for you to consider taking further action to reduce that employee's exposure. Health surveillance results should be used to check the long-term effectiveness of your control measures. If the number of employees with HAVS has increased, or if the disease is progressing in affected individuals, you need to review your risk assessment and action plan [1].

### **What if no symptoms are reported?**

If no symptoms are reported on the screening questionnaire, there is no need to refer the employee for further assessment, but they should complete the simple questionnaire again on an annual basis (Tier 2). HSE recommends that after three years of a vibration-exposed employee reporting no symptoms they should be referred for a consultation with an occupational health nurse to provide an opportunity to explore more fully any possible symptoms that the individual may have overlooked.

### **What type of records should I keep?**

You should keep a health record for each individual for as long as they are under health surveillance, although you may wish to retain it for longer. It is good practice to offer individual employees a copy of their health records when they leave your employment, if your business should cease trading or the employee ceases to be exposed to vibration. The record should be kept up to date and should include:

- identification details of the employee;
- the employee's history of exposure to vibration;
- the outcome of previous health surveillance in terms of fitness for work, and any restrictions required;

Health records should not contain personal medical information, which must be kept in confidence in the medical record held by the occupational health professional. The enforcing authority is entitled to ask to see your health records as part of their checks that you are complying with the Vibration Regulations [1].

## **Could an occupational health service provider carry out a complete health surveillance service?**

Health surveillance may consist of an evaluation of the case history for a worker in conjunction with a physical examination conducted by a doctor or suitably qualified health-care professional[3].

### **The case history**

The case history should focus on:

- family history,
- social history, including smoking habit and alcohol consumption.
- work history, including past and current occupations with exposure to hand-arm vibration, previous jobs with exposure to neurotoxic or angiotoxic agents and any leisure activities involving the use of vibrating tools or machines.
- personal health history.

### **The physical examination**

A physical examination should look in detail at the peripheral vascular, neurological, and musculoskeletal systems, and should be performed by a qualified physician [3]

### **Clinical tests**

In general, clinical tests do not provide reliable proof of vibration injury, however, they may be helpful to exclude other causes of symptoms similar to those of hand-arm vibration syndrome or to monitor progression of injury. Tests for the peripheral vascular system include the Lewis-Prusik test, the Allen test, and the Adson test.

Tests for the peripheral nervous system include the evaluation of manual dexterity (e.g. coin recognition and pick up), the Roos test, the Phalen's test and the Tinel's sign (for carpal tunnel compression)[3].

### **Vascular investigations**

The vascular assessment of the hand-arm vibration syndrome is mainly based on cold provocation tests: assessing changes in finger colour, recording recovery times of finger skin temperature, and measuring finger systolic blood pressure. Other noninvasive diagnostic tests, such as Doppler recording of arm and finger blood-flow and pressure, may also be useful [3].

### **Neurological investigations**

The neurological assessment of the hand-arm vibration syndrome includes several tests:

- Vibration perception thresholds
- Tactile sensitivity (gap detection, monofilaments)
- Thermal perception thresholds
- Nerve conduction velocities in the upper and lower limbs.
- Electromyography.
- Fingertip dexterity (Purdue pegboard) [3].

### **Muscle strength investigations**

The evaluation of muscle force in the hand can be performed by means of a dynamometer to measure grip strength and a pinch gauge to measure pinch strengths.

## **Radiological investigations**

X-rays of the shoulders, elbows, wrists and hands for a radiological diagnosis of bone and joint disorders are usually required in those countries in which vibration-induced osteoarthropathy in the upper limbs is recognised as an occupational disease.

## **Laboratory tests**

Blood and urine analyses may be necessary in some case to distinguish vibration injury from other vascular or neurological disorders [3].

## **CONCLUSION**

Health surveillance is about putting in place systematic, regular and appropriate procedures for the detection of work-related ill health, and acting on the results. The aims are primarily to safeguard the health of workers (including identifying and protecting individuals at increased risk), but also to check the long-term effectiveness of control measures. Health surveillance may consist of an evaluation of the case history for a worker in conjunction with a physical examination conducted by a doctor or suitably qualified health-care professional. Complete health surveillance is: the case history, the physical examination, clinical tests, vascular investigations, neurological investigations, muscle strength investigations, radiological investigations and laboratory tests.

## **REFERENCES**

- [1] <http://www.hse.gov.uk/vibration/hav/advicetoemployers/havsemployers.pdf>
  - [2] <http://resource.isvr.soton.ac.uk/HRV/VIBGUIDE/HAV%20Good%20practice%20Guide%20V7.7%20English%20260506.pdf>
  - [3] [http://www.who.int/occupational\\_health/pwh\\_guidance\\_no.10\\_teaching\\_materials.pdf](http://www.who.int/occupational_health/pwh_guidance_no.10_teaching_materials.pdf)
- ISO 13091-1:2001 Mechanical vibration — Vibrotactile perception thresholds for the assessment of nerve dysfunction — Part 1: Methods of measurement at the fingertips
- ISO 14835-1:2005 Mechanical vibration and shock — Cold provocation tests for the assessment of peripheral vascular function — Part 1: Measurement and evaluation of finger skin temperature
- ISO 14835-2:2005 Mechanical vibration and shock — Cold provocation tests for the assessment of peripheral vascular function — Part 2: Measurement and evaluation of finger systolic blood pressure

V International Conference  
„ECOLOGY OF URBAN AREAS“ 2016

## EXPOSURE TO HAND-ARM VIBRATION, TOOLS FOR CALCULATING DAILY EXPOSURES AND MEASUREMENT

Vladimir Šinik<sup>1</sup>, Željko Despotović<sup>2</sup>, Slobodan Janković<sup>1</sup>

<sup>1</sup>University of Novi Sad, Technical faculty "Mihajlo Pupin" Zrenjanin, Serbia

<sup>2</sup>Institute — Mihajlo Pupin, Belgrade, Serbia

sinik.vladimir@gmail.com

### ABSTRACT

*In this paper we will discuss about undesirable human vibrations and the effect of over-exposure to human vibration. Very important what can be taken to reduce harmful and/or dangerous sources of vibration. The tools for calculating daily exposures are give: daily exposure graph, daily exposure nomogram, exposure points system. On the end is to give protocol for hand-arm vibration (hav) measurements.*

### INTRODUCTION

EU Directive 2002/44/EC (the ‘Vibration Directive’) places responsibilities on employers to ensure that risks from hand-arm vibration are eliminated or reduced to a minimum [1]. If employees are at risk, employers and equipment manufacturers must consider what action is needed to reduce the risk so far as is reasonably practicable. This will meet the requirements of general legislation including the Health and Safety at Work etc Act 1974 and the Management of Health and Safety at Work Regulations 1999 as well as The Control of Vibration at Work Regulations 2005. Regular exposure to high vibration levels may cause various kinds of injury to the hands, arms and body including impaired blood circulation damage to the nerves, muscles and soft tissue [2].

Vibrations arise when a body oscillates due to external and internal forces. In the case of hand-arm vibration, the handle of a machine or the surface of a work piece vibrates rapidly, and this motion is transmitted into the hand and arm. Hand-arm vibration (HAV) is vibration transmitted to the hand and arm during the operation of hand-held power tools and hand-guided plant, or while holding materials being processed by plant. HAV is commonly experienced by workers (Fig.1.) who regularly use power tools including jackhammers, chainsaws, grinders, drills, riveters and impact wrenches.





Figure 1. Hand-arm vibration

The risks from hand-arm vibration affect people across many industries and occupations. The risks are greatly increased with use of higher vibration equipment and with prolonged and regular use of the equipment. However, investigations have shown that vibration hazards can be controlled and risks reduced by good management. Directive 2002/44/EC gives ‘exposure limit values’ and ‘exposure action values’. It also specifies employers' obligations with regard to determining and assessing risks, sets out the measures to be taken to reduce or avoid exposure and details how to provide information and training for workers. Any employer who intends to carry out work involving risks arising from exposure to vibration must implement a series of protection measures before and during the work. The Directive also requires the Member States of the EU to put in place a suitable system for monitoring the health of workers exposed to risks arising from vibration. The Vibration Directive sets an exposure action value for daily vibration exposure, above which it requires employers to control the hand arm vibration risks of their workforce and an exposure limit value above which workers must not be exposed

- a daily exposure action value of  $2.5 \text{ m/s}^2$
- a daily exposure limit value of  $5 \text{ m/s}^2$

However, there is some risk of hand-arm vibration injury where exposures are below the exposure action value. The Vibration Directive places responsibilities on employers to ensure that risks from hand-arm vibration are eliminated or reduced to a minimum [1].

## TOOLS FOR CALCULATING DAILY EXPOSURES

### Daily exposure graph

The graph in Fig. 2 gives a simple alternative method for looking up daily exposures or partial vibration exposures without the need for a calculator. Simply look on the graph for the  $A(8)$  line at or just above where your vibration magnitude value and exposure time lines meet.

The green area in Fig. 2 indicates exposures likely to be below the exposure action value. These exposures must not be assumed to be “safe”. There may be a risk of hand-arm vibration injury for exposures below the exposure action value, and so some exposures within the green area may cause vibration injury in some workers, especially after many years of exposure.

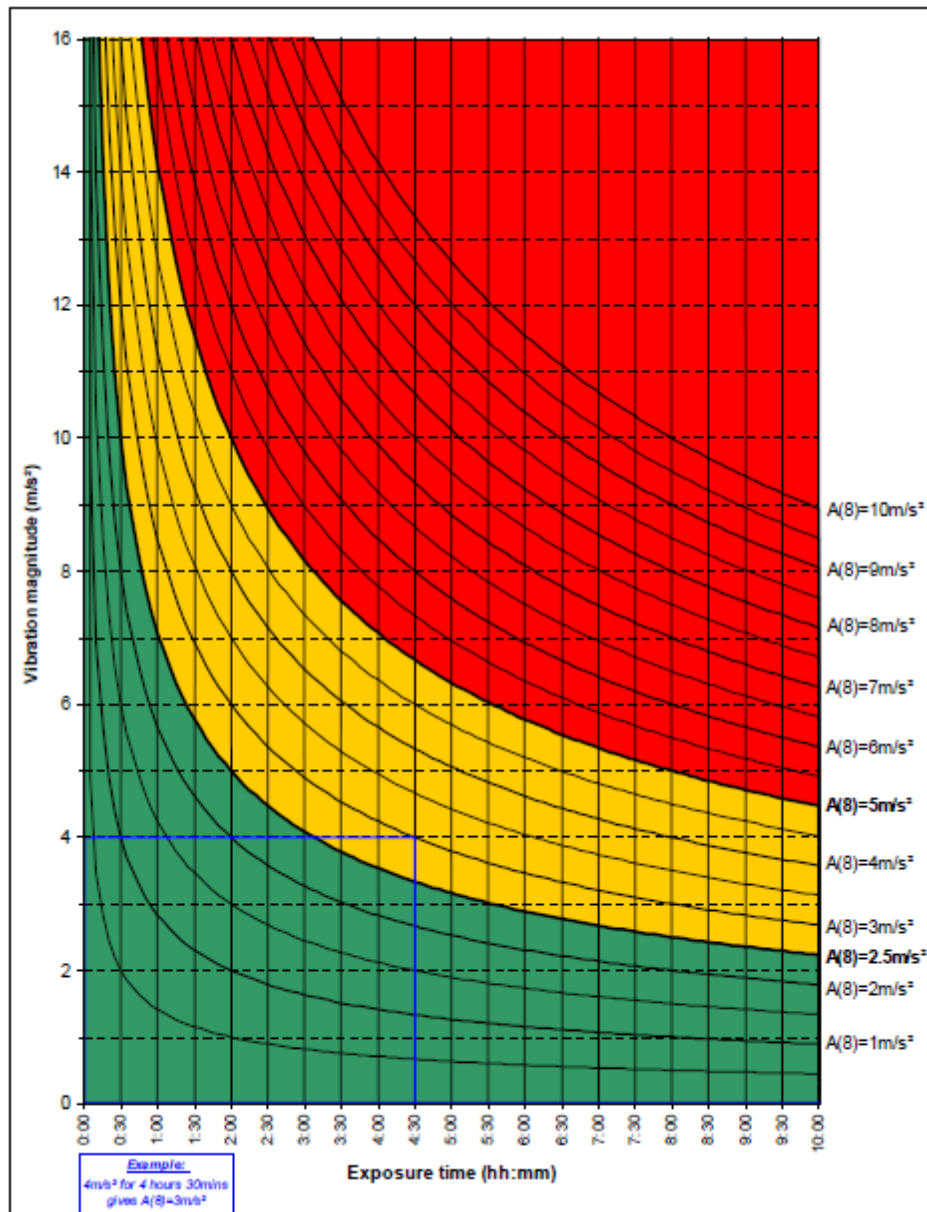

Fig. 2 Daily exposure graph[1]

### Daily exposure nomogram

The nomogram in Fig.3 provides a simple alternative method of obtaining daily vibration exposures, without using the equations. For each tool or process:

1. Draw a line from a point on the left hand scale (representing the vibration magnitude) to a point on the right hand scale (representing the exposure time);
2. Read off the partial exposures where the lines cross the central scale;
3. Square each partial vibration exposure value;
4. Add the squared values together;
5. Take the square root of the result to give the overall A(8) daily vibration exposure value[1].

### Exposure points system

Hand-arm vibration exposure management can be simplified by using an exposure “points” system. For any tool or process, the number of exposure points accumulated in an hour (PE,1h in points per hour) can be obtained from the vibration magnitude  $a_{hv}$  in m/s<sup>2</sup> using:

$$P_{E,1h} = 2a_{hv}^2$$

Exposure points are simply added together, so you can set a maximum number of exposure points for any person in one day.

The exposure scores corresponding to the exposure action and limit values are:

- exposure action value ( $2.5 \text{ m/s}^2$ ) = 100 points;
- exposure limit value ( $5 \text{ m/s}^2$ ) = 400 points.

In general the number of exposure points,  $PE$ , is defined by:

$$P_E = \left( \frac{a_{hv}}{2,5 \text{ m/s}^2} \right)^2 \frac{T}{8 \text{ hours}} 100$$

Where  $a_{hv}$  is the vibration magnitude in  $\text{m/s}^2$  and  $T$  is the exposure time in hours. Alternatively Fig.4 gives a simple method for looking up the exposure points. The daily exposure  $A(8)$ , can be calculated from the exposure point using [1]:

$$A(8) = 2,5 \text{ m/s}^2 \sqrt{\frac{P_E}{100}}$$

## A VIBRATION MEASUREMENT SYSTEM

### Background

Since man began to build machines for industrial use, and especially since motors have been used to power them, problems of vibration reduction and isolation have engaged engineers. Gradually, as vibration isolation and reduction techniques have become an integral part of machine design, the need for accurate measurement and analysis of mechanical vibration has grown. This need was largely satisfied, for the slow and robust machines of yesteryear, by the experienced ear and touch of the plant engineer, or by simple optical instruments measuring vibratory displacement. Over the last 15 or 20 years a whole new technology of vibration measurement has been developed which is suitable for investigating modern highly stressed, high speed machinery. Using piezoelectric accelerometers to convert vibratory motion into an electrical signal, the process of measurement and analysis is ably performed by the versatile abilities of electronics.

In many situations it will not be necessary to measure vibration magnitudes. However, it is important to know when to conduct measurements. Sometimes it may not be possible to obtain adequate information (from equipment suppliers or other sources) on the vibration produced by a tool or work process.



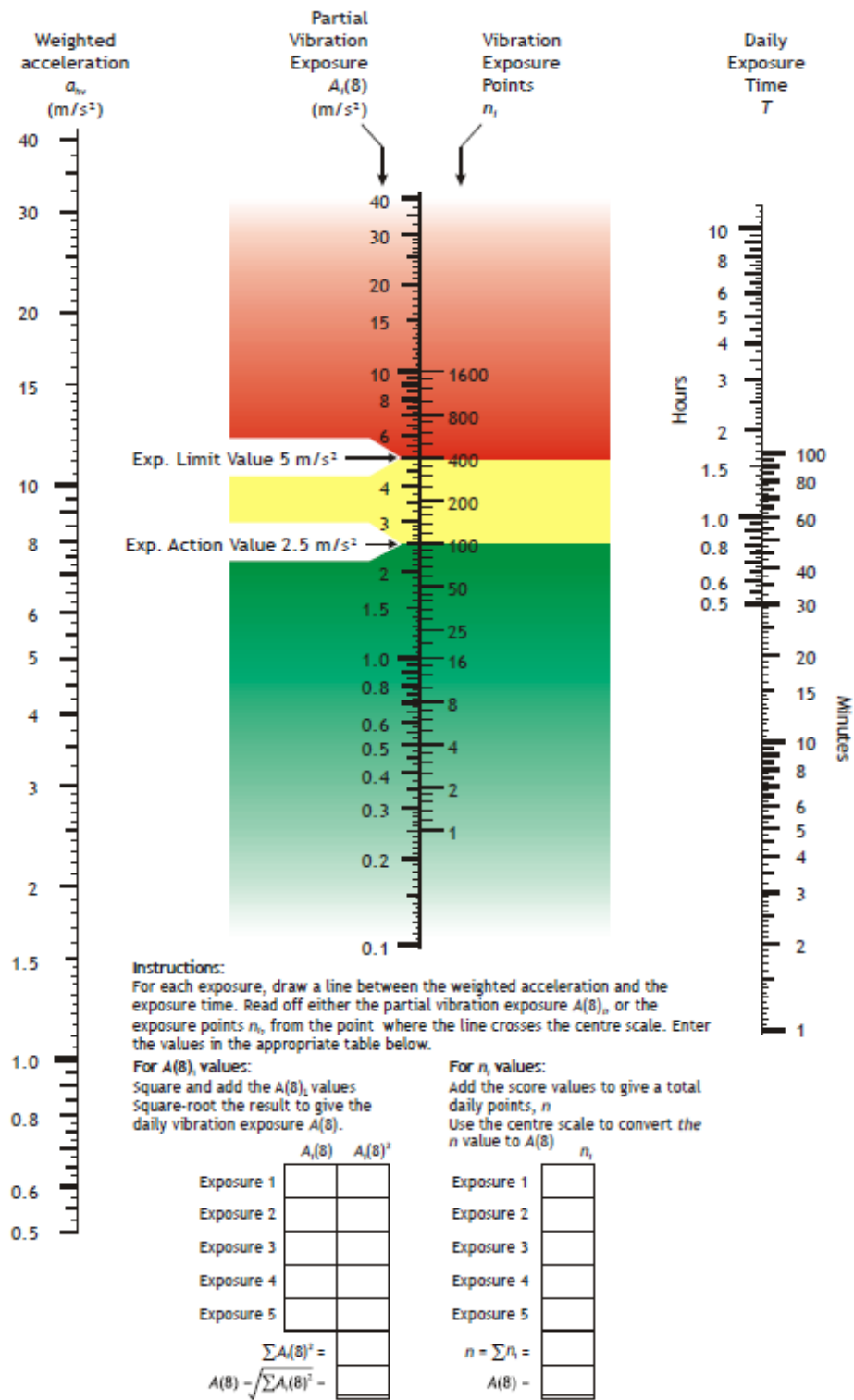

Fig. 3 Hand-arm vibration exposure nomogram[1]

20	67	200	400	800	1600	2400	3200	4000	4800	6400	8000
19.5	63	190	380	760	1500	2300	3050	3800	4550	6100	7600
19	60	180	360	720	1450	2150	2900	3600	4350	5800	7200
18.5	57	170	340	685	1350	2050	2750	3400	4100	5500	6850
18	54	160	325	650	1300	1950	2600	3250	3900	5200	6500
17.5	51	155	305	615	1250	1850	2450	3050	3700	4900	6150
17	48	145	290	580	1150	1750	2300	2900	3450	4600	5800
16.5	45	135	270	545	1100	1650	2200	2700	3250	4350	5450
16	43	130	255	510	1000	1550	2050	2550	3050	4100	5100
15.5	40	120	240	480	960	1450	1900	2400	2900	3850	4800
15	38	115	225	450	900	1350	1800	2250	2700	3600	4500
14.5	35	105	210	420	840	1250	1700	2100	2500	3350	4200
14	33	98	195	390	785	1200	1550	1950	2350	3150	3900
13.5	30	91	180	365	730	1100	1450	1800	2200	2900	3650
13	28	85	170	340	675	1000	1350	1700	2050	2700	3400
12.5	26	78	155	315	625	940	1250	1550	1900	2500	3150
12	24	72	145	290	575	865	1150	1450	1750	2300	2900
11.5	22	66	130	265	530	795	1050	1300	1600	2100	2650
11	20	61	120	240	485	725	970	1200	1450	1950	2400
10.5	18	55	110	220	440	660	880	1100	1300	1750	2200
10	17	50	100	200	400	600	800	1000	1200	1600	2000
9.5	15	45	90	180	360	540	720	905	1100	1450	1800
9	14	41	81	160	325	485	650	810	970	1300	1600
8.5	12	36	72	145	290	435	580	725	865	1150	1450
8	11	32	64	130	255	385	510	640	770	1000	1300
7.5	9	28	56	115	225	340	450	565	675	900	1150
7	8	25	49	98	195	295	390	490	590	785	980
6.5	7	21	42	85	170	255	340	425	505	675	845
6	6	18	36	72	145	215	290	360	430	575	720
5.5	5	15	30	61	120	180	240	305	365	485	605
5	4	13	25	50	100	150	200	250	300	400	500
4.5	3	10	20	41	81	120	160	205	245	325	405
4	3	8	16	32	64	96	130	160	190	255	320
3.5	2	6	12	25	49	74	98	125	145	195	245
3	2	5	9	18	36	54	72	90	110	145	180
2.5	1	3	6	13	25	38	50	63	75	100	125
	5m	15m	30m	1h	2h	3h	4h	5h	6h	8h	10h

Fig.4 Exposure points table (rounded values).[1]

It maythen be necessary to make measurements of vibration in the workplace. Vibration measurement is a difficult and complex task. You may choose to make the measurements in-house, or to employ a specialist consultant. In either case, it is important that whoever makes the measurements has sufficient competence and experience [1].

Human exposure to hand-arm vibration should be evaluated using the method defined in European Standard EN ISO 5349-1:2001 and detailed practical guidance on using the method for measurement of vibration at the workplace is given in EN ISO 5349-2:2001.

Measurements should be made to produce vibration values that are representative of the average vibration for a tool or process throughout the operator’s working period. It is therefore important that the operating conditions and measurement periods are selected to achieve this. Where tools are held in both hands, measurements must be made at both hand positions and the highest value used for determining vibration exposure [1].

For HAV the triaxial sum of the acceleration experienced by the worker in the three axes (x, y and z) as shown in Fig.5 is used in calculation of the daily vibration exposure A(8). This is different from whole-body vibration (WBV) where the axis with the highest average root mean square (RMS) acceleration is used in calculation of the daily vibration exposure A(8).

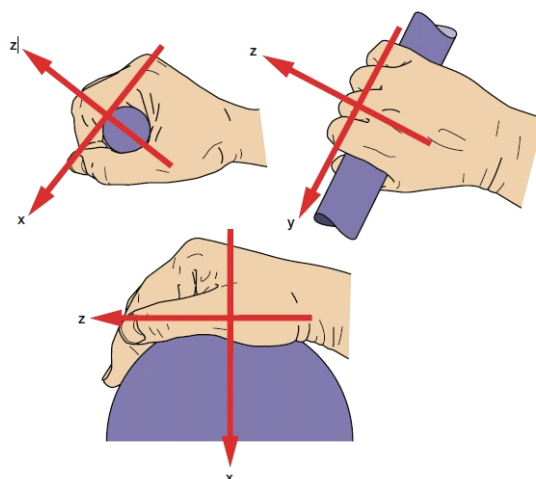

*Fig.5 Axes of hand-arm vibration measurement*

The illustration(Fig.6) shows a simplified block diagram of a Bruel & Kjaer human-vibration measurement system. Accelerometers are used to measure vibration levels. If triaxial measurements are required, three accelerometers may be connected up to the measurement system so that vibrations in the x, y and z directions can be measured and recorded either simultaneously or consecutively.

The signal from the accelerometer is first passed through a preamplifier. This amplified signal is then weighted – to allow for the variation of human response to vibrations of different frequencies - by passing it through a frequency weighting filter. Different filters are available to weight whole-body, and hand-arm vibrations measured in the x, y and z directions. A special filter is also able to weight whole-body vibration and shock transmitted through building structures[4].

Frequency-weighting is in accordance with all the current ISO Standards. After the signal has been weighted, it is amplified again and rectified in the RMS detector before being converted into a digital signal which is then passed to a microprocessor which enables the following parameters to be read out during a measurement: Instantaneous and equivalent RMS Values; Instantaneous and Maximum Peak Values; Maximum and Minimum RMS values, and the following parameters when the measurement is complete: the total equivalent acceleration value  $a_{eq}$ , Maximum Peak Value, Maximum RMS; and Minimum RMS for the total measurement time, T.

All these quantities can be displayed on a digital and a quasi-analogue read-out. The AC output enables vibration signals to be tape recorded for further analysis - for example, third-octave analysis as recommended in the relevant ISO Standards (see later section in this booklet). A digital output enables measurement results to be plotted and/or printed out[4].

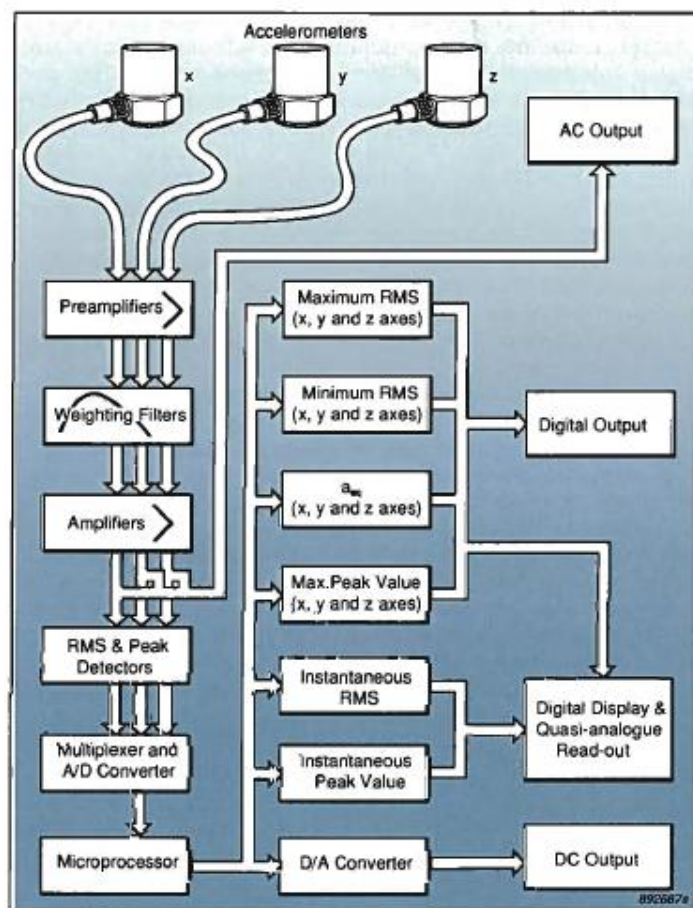

Fig.6 Simplified block diagram of a Bruel & Kjaer human-vibration measurement system[4].

## Protocol for hand-arm transmitted vibration (hav) measurements

### 1. Measuring equipment

Vibration are measured by using an equipment able to provide the effective value (r.m.s. value) of the acceleration of the surface that comes in contact with the user's hand-arm system. Equipment shall be compliant to the Standard ISO 8041. The equipment shall be made, besides the accelerometers, by:

a) a spectrum analyser (at least three channels) without the recording chain. This method presents the advantage of an immediate reading of the acquired spectra, but does not allow the subsequent processing of the signals acquired by analysis modes that are different from those used in the acquisition phase;

or:

b) a measurement signal recorder (at least three channels). The signal is then analysed by a spectrum analyser. The recorder shall necessarily be equipped with an overload gauge, in order to prevent distortions in the recorded signal. For the purposes of quality control of measurements to be inserted in the VDB, the spectral analysis of measurements, in thirds of octave, is required.

### Measurement procedures

Measurements shall be compliant to the Standards ISO 5349-1 and ISO 5349-2. If the accelerometer is attached directly on the vibrating handle, metal or plastic clips shall be used. If the accelerometer is mounted directly on an adapter, its transfer function shall be known; such transfer function can be provided by the manufacturer or directly measured by the Laboratory. Mechanical Filters : in the case of measurements on percussive or roto-percussive tools, in order to exclude the "dc shift"

phenomenon, which entails the total unreliability of the measurement results, a mechanical filter with a wellknown transfer function shall be put between the accelerometer and the handle[3].

## 2. Duration of measurement

The total measurement time, i.e. the number of acquired samples multiplied by the duration of acquisition of each sample, shall last at least one minute. If the operation to be measured has a duration of vibration which is less than 1 min, the recording of such operation can be repeated a number of times until the total duration of the records of the operation is not less than 1 min. Any movement of the vibrating tool occurred during a measurement, such as, for example the normal change of position of a workpiece being worked, the replacement of accessories, the displacement of the tool for machining requirements, etc., can generate noise signals during the data acquisition phase. Such interferences can be excluded by performing the measurements in simulated conditions, which therefore generally appear preferable for the assessment of hand-arm system transmitted vibration[3].

## 3. Assessment of uncertainty

The uncertainty factors that follow shall be assessed; the person responsible for the measurement shall determine, in each specific case, the main sources of uncertainty, and, in accordance to that, increase the number of acceleration measurements in order to quantify, by calculating the standard deviation, the extent of the error associated with the main indetermination factors.

The measuring equipment and the related calibrator shall undergo calibration at an accredited calibration laboratory (national or EA center) at least every two years.

### Uncertainty factors

a) Biases due to the acquisition system (weight, location and mounting of accelerometers, electrical interferences, calibration). These measurement errors can be minimized by selecting an appropriate measurement technique. In this case the measurement error associated with this component is  $< 4\%$ .

b) Errors due to random fluctuations of the concerned physical parameters (temperature, humidity, stability of the machine power supply, homogeneity of the material being worked, etc.). These errors can be minimized by increasing statistics of the samples. The estimate of the random measurement error is obtained by the standard deviation (or from the standard deviation) of at least three measurements performed under identical experimental conditions. The operating characteristics shall be reported in detail in the description of the measurements.

c) Changes in the ways of use of the working tool by different operators: this factor shall be taken into account, since the exposure reported in the test report is assessed for homogeneous working tasks and not for the individual worker. The measurements shall be repeated in the same operating conditions, with at least two operators displaying different anthropometric characteristics and/or professional experience. If the coefficient of variation of the performed measurements is greater than 20% the number of measurements shall be increased by including a third operator.

d) Changes in the maintenance conditions of the tool (e.g.: unbalancing of the disk in the case of grinders, wear of tools, etc. ). The measurements shall be carried out on equipment in good maintenance conditions[3].

## CONCLUSION

The evaluation and assessment of risks arising from exposure to vibration and the implementation of protection measures can be complicated. The risks from hand-arm vibration affect people across many industries and occupations. The risks are greatly increased with use of higher vibration equipment and with prolonged and regular use of the equipment. However, investigations have shown that vibration

hazards can be controlled and risks reduced by good management. It is important that accelerometers (vibration transducers) are carefully selected. The purpose of the hand-arm vibration risk assessment is to enable you as the employer to make a valid decision about the measures necessary to prevent or adequately control the risks from exposure of workers to hand-arm vibration. The vibration on handheld and hand-guided machines can be very high and can easily overload unsuitable transducers. Fixing transducers to the machine handles requires mounting systems that are rigid, lightweight and compact.

## REFERENCES

- [1][http://resource.isvr.soton.ac.uk/HRV/VIBGUIDE/2008\\_11\\_08%20WBV\\_Good\\_practice\\_Guide%20v6.7h%20English.pdf](http://resource.isvr.soton.ac.uk/HRV/VIBGUIDE/2008_11_08%20WBV_Good_practice_Guide%20v6.7h%20English.pdf)
- [2]<http://www.westlothian.gov.uk/media/1839/Hand-Arm-Vibration-Procedure/pdf/hand-arm-vibration-proced.pdf>
- [3][http://www.portaleagentifisici.it/filemanager/userfiles/PROTOCOLLI/Vibrazioni\\_hav\\_da\\_misuratore\\_EN.pdf?lg=EN](http://www.portaleagentifisici.it/filemanager/userfiles/PROTOCOLLI/Vibrazioni_hav_da_misuratore_EN.pdf?lg=EN)
- [4] <http://www.bksv.com/doc/br056.pdf>
- Directive 2002/44/EC of the European parliament and of the Council of 25 June 2002 on the minimum health and safety requirements regarding the exposure of workers to the risks arising from physical agents (vibration) (sixteenth individual Directive within the meaning of Article 16(1) of Directive 89/391/EEC)
- Directive 98/37/EC of the European parliament and of the Council of 22 June 1998 on the approximation of the laws of the Member States relating to machinery
- Council Directive 89/656/EEC of 30 November 1989 on the minimum health and safety requirements for the use by workers of personal protective equipment at the workplace (third individual directive within the meaning of Article 16 (1) of Directive 89/391/EEC)
- European Committee for Standardization (2001) Mechanical vibration — Measurement and evaluation of human exposure to hand-transmitted vibration — Part 1: General requirements  
EN ISO 5349-1:2001.
- European Committee for Standardization (2001) Mechanical vibration — Measurement and evaluation of human exposure to hand-transmitted vibration — Part 2: Practical guidance for measurement at the workplace  
EN ISO 5349-2:2001.
- European Committee for Standardization (1996) Mechanical vibration and shock — Hand-arm vibration — Method for the measurement and evaluation of the vibration transmissibility of gloves at the palm of the hand  
EN ISO 10819:1996
- European Committee for Standardization (1997) Mechanical vibration — Declaration and verification of vibration emission values  
EN 12096:1997
- ISO 14835-2:2005 Mechanical vibration and shock — Cold provocation tests for the assessment of peripheral vascular function — Part 2: Measurement and evaluation of finger systolic blood pressure

## **SPATIAL PLANNING AND GREENING IN URBAN AREAS**

V International Conference  
„ECOLOGY OF URBAN AREAS“ 2016

**ECOLOGICAL BUILDING CULTURE AND GREEN BUILDINGS;  
VERTICAL AND ROOF GARDENS**

**Aysun TUNA<sup>1\*</sup>, Parisa GÖKER<sup>2</sup>**

<sup>1\*</sup>Inonu University, Faculty of Fine Art and Design, Department of Landscape Architecture, Malatya/Turkey

<sup>2</sup>Ankara University, Agriculture Faculty, Department of Landscape Architecture, Ankara/Turkey  
aysuntuna17@gmail.com, p.aliasghari.au@gmail.com

**ABSTRACT**

*Ever-growing high buildings cause also heating of the air as well as pollution by blocking the air circulation. Decreasing of the soil to be absorbed the rain as a result of concretion leads to fall more burdens on waste water systems of the cities, while increasing the use of water in the cities and industrial areas. Many cities have to struggle with floods due to selection of wrong location and inadequate infrastructure. Our environment, as a result of development of rapidly and irregular of especially our large cities, is covered with concrete and asphalt on a large scale. Green spaces requiring being available in the city leave their places to the concrete structure, by cannot withstand the intense pressure of residential functions and workplaces. The air pollution becomes the main issue of many cities. One of the most effective way against this case is to re-design and apply the plant areas lost on the structure which have destroyed themselves, in other words, it will be the greening of the roofs. The most important factor to prevent it is the protection of green spaces in urban areas and the development of alternative green space applications. In the cities rapidly overbuilding in which protection opportunity of green spaces is gradually decreased; the conversion of different building parts and surfaces into green spaces with herbal applications in roof, terraces and facades as well as parks and gardens is of vital importance not only in terms of aesthetics and visual quality and also their contribution to urban ecology. Vertical planting, which brought a new dimension to today's modern architecture, consists of a garden that positioned on a facade or a wall. Besides its aesthetical function, planting the vertical surfaces has great contributions to urban ecology within the scope of protection of buildings, optimization of the climatic influences, improving the environmental conditions and reducing environmental problems. This statement, within the context of features of ecological building and green building culture design case and their contribution to the environment; was assessed. On the other hand problems and opportunities of how to prevent the damages caused by environmental problems with such urban building culture in the context of urban ecology and sustainable cities were discussed.*

**Key Words:** Ecological building, Green Building, Vertical garden, roof garden.

**AIMS**

As a result of changing conditions in the world, there is an increase in population in cities, and structural intensity in urban areas augments based on technological developments, and urban construction and structuring, which will change form, go thorough changes as well; in this context, more vehicle, building and environmental- resource usage is discussed. All of these changes bring along air pollution and many factors harmful to human health. The primer facts characterized as environmental problems today are rapid population increase, rapid loss of natural and cultural resources as a result of industrialization and imperfect urbanization and leaving their places to a structural mass. Rapid decrease of green areas in the urban texture especially leads to the loss of ecologic balance; the habitats established by vegetation existence, which shows dynamic characteristics, are rapidly used up.

**BACKGROUND**

Ecological planning, ecological structure design, green structures and studies related to the design of sustainable and environmentally-friendly structures made up the major material of the research. In this context, any type of literature data (books, research, theses, brochures, papers, etc.) was evaluated as supportive material. Application for vegetation of structure surfaces performed in the national and



international scale, and findings such as visual material, projects, etc. were reviewed in the scope of the research.

## **RESULTS AND DISCUSSION**

### **Ecology and Structure Culture**

Damages and destructions generated in the environment because of desensitized societies have increased rapidly and thus the concept of ecology gained importance. Structure and urban ecology concepts emerged with the claims of the people for living in more healthy environments and more comfortably. Ecology is a phenomenon including the relationship of all living beings within themselves and their environment; including human-nature-environment structural relationship directly when it is evaluated in the structural meaning. In Greek, “ecology” means “oikos: house”, and it is a discipline investigating the relationship of living beings with their environment. It meant “animal and plant economy” at the beginning, and until recently, it was recognized as a field of biology, and after the 1970’s, with the environmental problems gaining importance, it was expanded by taking the human-nature relationship in its content (Erdoğan, et al., 2014).

When it is evaluated in the environmental/urban shaping and structure culture, structuring, which is suitable to the existing local ecology and compatible to the habitats formed by it and suitable to both global and local ecological characteristics and where harmonized and natural balance is protected and regarded, becomes important.

### **Ecological Structure Design**

Since improved environmental problems are important, “structural biology”, “ecological structuring” and “ecologic design” phenomenon have been brought to the agenda. Biological structuring, environmentally sensitive, nature-harmonized structuring is a structural design using the environmental resources and energy efficiently, and suitable to climatic and local environmental conditions and values by means of recyclable structural material usage. Here, energy effective and effectively isolated buildings/structures aiming to benefit from sun energy, preferring natural structure material, using the recycling techniques, self-sufficient and environmentally respectful, becoming integrated easily with the environment are regarded to be ecological structuring samples (Erdoğan, et al., 2014).

Fundamental components of ecological design are as follows;

- Structural area/land conditions; topography and geomorphology,
- Water resources,
- Air,
- Natural values/natural environment/ other environmental resources,
- Climate,
- Vegetation / existing plants.

### **Vertical Gardens**

Vertical planting is situating a garden on the wall of a building and brings a new understanding for current modern architecture. It provides significant contribution to urban ecology due to vertical surface planting in structures in addition to its aesthetic function and protection of structures, making the climatic effects more appropriate for human beings, improving environmental conditions and minimizing some of the environmental conditions due to its functions (Kemaloğlu, et.al. 1991)

## **Usage of Plant Material on Building Façades and Its Contribution to Urban Ecology**

Rigid surfaces such as concrete and asphalt contribute to the heat island effect, which is a rapidly growing problem in urban areas. Dry walls, roofs and streets act like a reflector and absorb some of the energy and reflect some of it from hard surfaces. Heat that is absorbed by hard surfaces during the day after sunset is released and it forms dome-shaped heat islands covering the city. This formation in the city ends up with the generation of hot points in other cold sections of rural areas (Aksoy and Icmek, 2010).

Vertical gardens absorb dust and other pollutants and harmful materials in the air by the aid of plant components and contribute to the formation of a healthier environment. Moreover, they absorb hazardous carbon dioxide in the air and release oxygen to the atmosphere and affect micro climate of the city favorably and ensure an increase of oxygen amount in urban areas (Aliasghari Khabbazi et.al, 2012).

### **Noise Level Reduction**

Soil and plant material used for plant arrangement in vertical gardens have a sound-absorbing characteristic. Therefore, they function to reduce noise generated both within the building and immediate vicinity of the building.

### **Oxygen Production**

Solution of air pollution, one of the important problems of cities, depends on the presence of as much as possible green texture in addition to reaching correct area usage decisions. An increase in plant density augments oxygen production and carbon dioxide consumption and plays an effective role in the renewal of urban atmosphere. As a result of planting even a single wall of a two-floor building, oxygen production and carbon dioxide consumption is achieved in a value reached by a large tree. Considering it in a very general sense, planting a single wall of 50 dwellings on any street is equivalent to planting 50 trees on this street.

### **Dust Collection and its Contribution in a Health Aspect**

Dust consists of deposits lifted from dry surfaces by wind without facing any obstacles. Planting, on the other hand, is the most significant process removing this effect. In addition to reducing wind speed, plants collect dust particles by means of humid settings that they form in their root or leaf regions. Owing to this incident, harmful microorganisms disappear by sap or secretions situated in the plant structure. Since one of the obstacles in front of wind in cities is dwelling walls, the significance of planting these walls is revealed clearly (Aliasghari Khabbazi et.al, 2012).

### **Aesthetic Contributions of Usage of Plant Material on Building Façades**

In addition to the effective usage of renewable energy sources and environmentally-conscious local material and pollution prevention and habitat protection, public health and aesthetic contributions are considered in ecological designs as well. Vertical gardens ensure crucial aesthetic contributions to urban areas with numerous and alternative design opportunities that they present and have a city ecology-improving effect.

Aesthetic and functional effects of plant material used on building surfaces depend on plant physiognomy and morphological properties. These are plant habitus and escalation form, habitus changing during the vegetation stages (shooting, flowering, leaf formation, etc.), changing during the transition from a vegetation stage to the other (growing, lignification, etc.), plant form and structure, leaf thickness, and vegetation density and color (Baris et.al, 2003).

## **Green Roof System**

When roof gardens, as urban greenery, are compared with other green areas, it is clear that there are significant differences in terms of both realization and healthy sustainability. Whereas existing areas are used in green areas other than roof gardens, an environment needs to be generated for roof gardens initially. Roof gardens are divided into intensive and extensive roof gardens in terms of function and benefiting properties. These categories are used in the explanation of different purposes, methods and different applications generally. Different ideas will reveal the type of method proper for the roof where the application will be made. Intensive roof gardens are flat roof arrangements, which require more than the growth environment with intensive afford and excessive growth inputs such as grass, bushes, shrubs and small trees, and application of various nonliving materials (pavement, sitting elements and water surfaces, etc.) (Küçükerbaş 1991).

It is mandatory that isolation, filtering, drainage and watering systems must be perfect in intensive roof gardens, which have a thick growth environment (200mm or more). Main target of such type of roof gardens is to provide open areas, serving recreational activities for people (Johnston, et.al. 1993). Intensive roof gardens have a thick soil layer and watering and drainage systems and provide more proper growth conditions in comparison to extensive green roofs, and they have various advantages and disadvantages.

### **Advantages**

- They provide growth of various vegetation on top of roofs.
- Soil and vegetation taking place in these gardens attribute to heat insulation of the buildings.
- Soil surfaces gained on structures provide new living environment for the fauna (birds, bees, butterflies, spiders, beetles, worms and ants, etc.) as well as for the plants.
- In addition to the functional benefits, they provide significant benefits for urban ecology and aesthetics. They have constructive effects for human health as well.
- They enable various utilization of roofs.

### **Disadvantages**

- They generate excessive load on roofs.
- Utilization of watering and drainage systems requires extra financial burdens.
- They are highly costly.
- They require more complex systems and technical perfection (Johnston1 et. al.1993).

## **STRUCTURAL CHARACTERISTICS OF GREEN ROOF SYSTEM**

Certain characteristics are sought in the roof overlay, due to both structural properties of the roof and growth environment to be prepared for vegetation. Since all of these characteristics cannot be found in a single layer, an overlay method is applied as layers. In this overlaying, the layer is ranged as carrying layer, insulation layer (water, heat and steam blocking insulation layers), separation layer, filter layer, substrate and vegetation layer. Structural walls such as flooring, windows, wind blockers, pergolas, steps and pools, which are thought as materials other than the plant material in roof gardens, should be designed based on the carrying capacity of the roof carrier system. Very light material should be used in roof gardens and strong yet light materials should be selected such as light concrete and light aluminum (Barış et al. 2003).

### **Plant**

Selection of the plants that are to be used in a planted roof varies according to the planted roof type that is to be used.

### **Plant Bearer Layer**

Plant species used in different climate conditions for green roof systems are as follows;

- Lichens
- Single year herbaceous
- Perennial Herbaceous
- Grass
- Alliaceous, tubercular and rhizome plants
- Succulents
- Short Ligneous

### **Filter Layer**

Today, geotextiles that are not braded are preferred as a material in the filter layer. Non-braded geotextiles are made of regularly or irregularly stacked fibers of various lengths. These fibers may form an overlay brought together with various mechanical, chemical or heat effects. Or they may be protected naturally and produced due to the structural characteristics of the tree itself used as a raw material.

### **Drainage Layer**

It is necessary that a drainage layer and drainage system is used for storing water requirement of plants and taking away the excess water from the buildings. In case excess water coming to the roof is not stored, plants cannot meet their water requirement when they need water and this leads to their death. If excess water is not drained away from the buildings, this leads to an excess load in the building carrier system, and water accumulating on the surface may also harm the plant layer (Toydemir, 2002).

### **Root Retaining Layer**

The purpose of the root retaining layer is to prevent water reaching to the layers and materials as a water insulating layer first of all, and thus preventing plant root harming and losing their function. Root retaining layer may be generated in two ways. In the first method, a protective layer is used for this requirement, similar to other layers. In the second method, root-retaining characteristics are gained with the aid of various chemicals on roof-carrier layover or on concrete surfaces like stems (Toydemir, 2002).

### **Water Isolation Layer**

Water isolation materials are used for the roof system sub layers and inner environment not to be harmed by rainwater. Water isolation material makes the roof system impermeable to water. Furthermore, a slope shaft can be used to collect the water accumulating on the roof, and a rainwater removal system can be used to take away the collected water.

### **Roof Carrier System Component**

The function of the roof carrier system is to transfer the vertical loads in the roof to the building carrier system safely (Toydemir 2002).

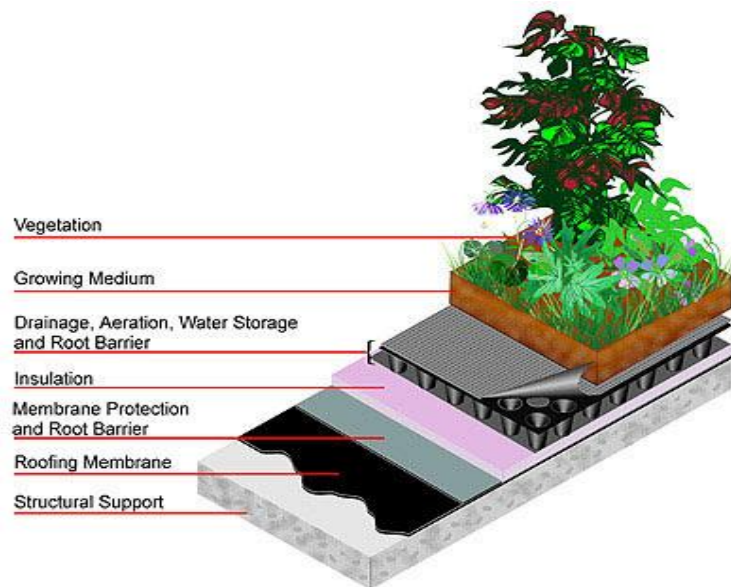

Figure 1. Green Roof System Constructions (URL 1: 2012)

## CONCLUSION

Ecological buildings are the formations built with energy efficient building materials that minimize needed energy by their design properties and energy consumption approaches. As far as energy consumption of the world was concerned, energy efficient building design has vital importance, by reducing the energy usage of buildings by means of green building design, we can contribute to the sustainability of nonrenewable energy sources. Besides, that energy can be used in order to promote the life quality of the world. By using the existing buildings stock, unhealthy, harmful and dense urban environment will be eliminated. Besides by means of environmentally sensitive green buildings, healthy and clean buildings integrated with natural values and in harmony with the environment will be obtained. So that healthy environments for future generation will be created.

There is a rapidly increasing need for roof gardens today due to rapidly increasing population and gradually decreasing green areas in large cities. Roof gardens balance surface flows, and regulate heat balances in the buildings and regulate excessive temperatures or other extreme climatic conditions generated by hard surfaces in cities. Roof gardens create green areas similar to natural areas in towns owing to their ecological and creative functions, and they have a vital role in the increase of green areas per person. However, roof gardens never take the place of a forest or any ecosystem in the nature. Green areas diminish in parallel to increased structuring today, and it is approved that green areas are won back by establishing roof gardens in buildings, which are actually supposed to be green areas. Roof gardens, which play an accessory role in the establishment of green area integrity in cities, have a significant role in people's lives owing to their economic and creative functions.

Planting building surfaces makes important contributions to urban ecology due to its aesthetic and visual values in both urban scale and single structure scale, and the functions including structure protection, making the climatic effect more suitable for humans, improvement of environmental conditions and diminishing some environmental problems.

Various effects occur in building surfaces and façades depending on plant type, light requirement and season. Therefore, plant selection is made based on the design purpose and target and the effects. Plant types that can grow in the ecological conditions of the building environment need to be used in building surface planting studies. Growing strength, growth direction and growth characteristics of plants, and their suitability to the structural system of the building where they are to be applied and to the material properties, and advance informing of the user about subjects including maintenance and

usage manner can be assessed as the prevention of harming of building surfaces where plant application has been made.

## REFERENCES

- Aksoy, Y. İçmek, S. Çatı Bahçelerinin Kent Yaşamındaki Yeri ve Önemi. 5. Ulusal Çatı ve Cephe Sempozyumu, 15-16 Nisan, İzmir, 2010
- AliasghariKhabbazi, P. Olgun, Y. Yazgan, M.E. Case Studies in The Planting of Structure Surfaces; Roof Gardens. Uluslararası Iconarch Kongresi Bildiri Kitabı, Konya, 2012
- Barış, M.E., Yazgan, M.E., Erdoğan, E. 2003. Çatı Bahçeleri.Saksılı Süs Bitkileri Üreticiler Derneği, Ankara
- Erbaş, Ö., Erbaş, E. 2008. Soğuk Buharlı Hava Nemlendirme Sisteminin İç Hava Kalitesinin İncelenmesi. I Mühendislik ve Teknoloji Sempozyumu, Çankaya Üniversitesi, 28-28 Nisan, Ankara
- Erdoğan, E. Aliasgharikhabbazi, P. 2013.Yapı Yüzeylerinde Bitki Kullanımı, Dikey Bahçeler ve Kent Ekolojisi. Türk Bilimsel Derlemeler Dergisi, 6 (1) 23-27
- Erdoğan, E. Erdinç, L. Peyzaj Yapıları. Ankara Üniversitesi Yayınları, Ankara, 2009
- Johnston, J., Newton, J. 1993. Green Roofs, Building Green A Guide to Using Plants on Roofs, Walls and Pavements. London Ecology Unit, London
- Küçükbaş, E. 1991. Ege Bölgesi Koşullarında Sığ Topraklar Üzerinde Az Bakımla (Ekstansif) Bitkilendirme Olanakları Üzeride Bir Çatı Çatı Bahçesi Örneğinde Araştırmalar. Institute of Science, Department of Landscape Architecture, Ege University, Phd thesis. Izmir
- Toydemir, N., 2002. Çatılar, Yapı Endüstri Merkezi, Istanbul
- URL-1: <http://www.greenspec.co.uk/green-roofs-1.php>, 2012

V International Conference  
„ECOLOGY OF URBAN AREAS“ 2016

**RESHAPING OF HUMAN CONSCIOUSNESS THROUGH  
SUSTAINABLE DORMITORY**

**Miljan Šunjević\*, Mirjana Vojinović-Miloradov, Darko Reba, Ivana Mihajlović**

Faculty of Technical Sciences, Novi Sad, Serbia

msunjevic@uns.ac.rs, miloradov@uns.ac.rs, rebad@uns.ac.rs, ivanamihajlovic@uns.ac.rs

**ABSTRACT**

*In twenty first century human consciousness of environment (air, water, soil and biota) reached new heights. Protecting environment became number one task, and one of the best ways for doing so is creating self sustainable system. Implementation of sustainability in existing systems must be followed by education, because educated people are carriers of cultural and economical progress. If we want to reshape human consciousness and their awareness of environment and surrounding, we need to influence young people while they are at their peak of education. That is why this project is based on indirect education through sustainable dormitory-students housing. Idea is that people can be reached and educated by living in eco and sustainable system, and when they finish with their studies they will reshape their environment based on eco and sustainable principles they learned while living in dormitory. Innovation and interdisciplinary approach makes this dormitory project perfect for reshaping of human consciousness for environment.*

**Key words:** sustainability, student dormitory, reshaping, environment, multidisciplinary.

**INTRODUCTION**

Requirements of new century are very demanding. Link with environment is specially emphasized. Fight to reduce pollution (in surrounding and on source) is still one of primary requirements. More innovations and multidisciplinary approaches are needed. Many regulations and initiatives are created by countries and organizations (European Environment Agency, United Nations Environmental Program, PAMSEA, and others) so all requirements can be achieved. One of the most important initiatives is based on changing environmental consciousness of humans so that sustainability of environmental protection can be maintained.

Environmental consciousness at the beginning of twenty first century is rapidly increasing and becoming very important part of human behavior and lives. Sustainability, as the crucial part of environmental consciousness must be specially taken into consideration and research. Understanding influence we have on our environment (air, water, soil and biota) and the ways we can reduce pollution we create, can be considered the basic premises of environmental consciousness.

British Government's Sustainable Development Strategy (DEFRA, 2005, p.25) assumes that "Behavior changes will be needed to deliver sustainable development. However, attitude and behavior change is a complex subject. Information alone does not lead to behavior change or close the so-called attitude behavior gap. One of the key elements of new approach is the need to engage people close to home." We can understand this as a realization of downfall for all past and current actions on human consciousness change to environmental. Realizing that, new ways and ideas are required to fill gap created by this system failure.

There are many studies researching socio-psychological and socio-cultural aspects of environmental behavior, and all of them agree at one point: giving lectures and trying to have instant-direct change of human consciousness is implausible and even with constant repeating have momentary effect, it can only tickle human consciousness, but for real change it requires more subtle way - through indirect learning. As it can be seen in figure 1. through direct learning only 30 % of learning subject can be memorized by brain, but through indirect learning we can enhance that up to 90 %.

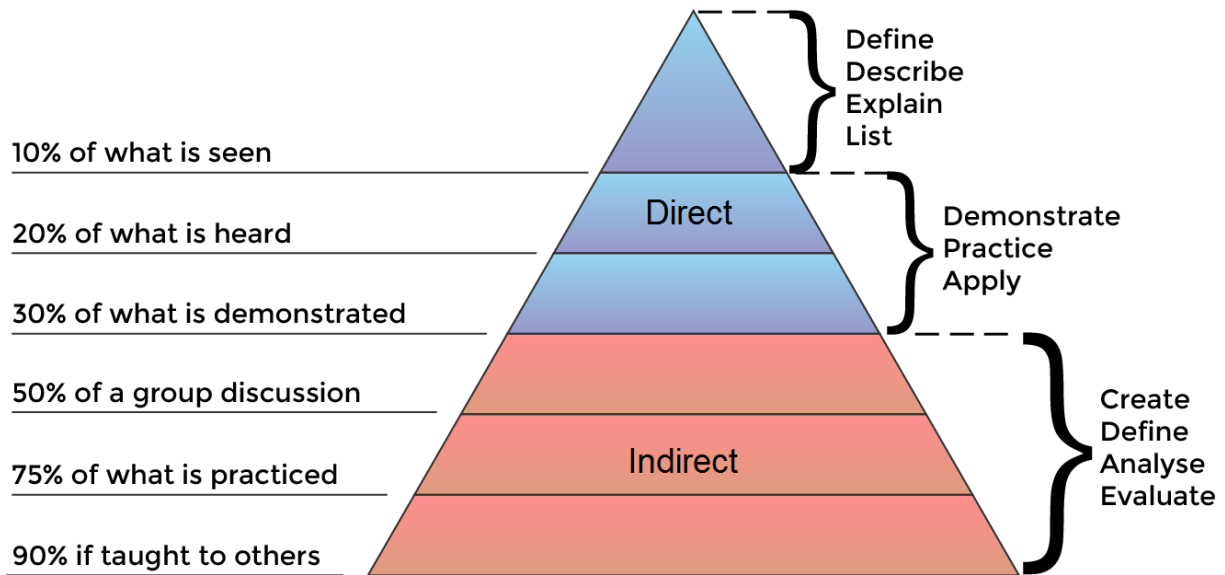

Figure 1. Cone of learning (blue-direct, red-indirect)

The other important factor that cannot be forgotten in learning is age of student. For better understanding cognitive development from birth through old age it is important to understand the nature of mental representation. The question how infants develop mental representation, in particular how they advance from sensory-motor experience to symbolic representation. The problem of aging and mental representation is approached widely believed to be stable in form and organization during adulthood, however older adults declines in ability to create new representations. At hart of this approach lies belief that cognitive learning decline with age (Craik, et al., 2006). The research conducted by Janacsek, Fiser and Nemeth continues and give final numbers to Burke's research. As visible in figure 2. the most quality age for learning is form age of 8 till age of 25, which corresponds with average students age.



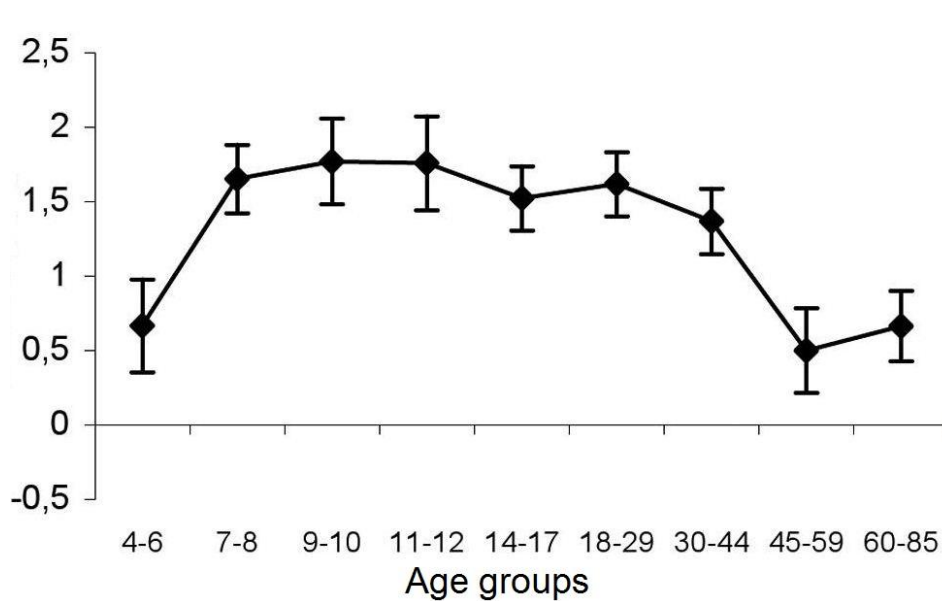

Figure 2. Learning by age groups

## MODEL

The basic idea is to provide solution for indirect learning and insight of advantages from sustainable systems through eco and sustainable students dormitory- students housing. It is also an alternative to existing conventional thinking and planning when students standards and life in general during the study is in question. One of main purpose for this kind of thinking is to make link between build environment and surrounding environment (air, water, soil and biota).

It is very important to leave enough space for multidisciplinary approach and for undertaking all important steps is project development. Beside basic forms we have two levels of thinking. Horizontally that represents poly-functionality, as well as vertically in shape of possibility of lifting another level with same energy resources.

To be able to understand what is needed for this kind of project, it is required to be familiar with global trends (environmental issues), the growing need for energy savings and rapid technological development of materials and components in construction as well as overall technology that changes our daily habits, lifestyle and thinking.

Sustainability demands:

- Low or no waste emission
- Low cost
- Low gasses emission
- Low energy use
- Connection with surrounding (link with environment)
- To be able to sustain by it self

Taking all that in consideration we also must be prepare to show it through MSD (Model of sustainable development) (Sunjevic, M. et al. 2016):

$$MSD = \int \sum (EC, CC, GC, SC, Mc, EcC, LF, nk)$$

Where:

EC-Environmental characteristics

CC-Climate characteristics

GC-Geological characteristics

SC-Spatial characteristics  
MC-Material characteristics  
EcC-Economical characteristics  
LF-Legislative framework  
nk-all other relevant characteristics

That demands implementation of benefit, easy, cheap, optimal material design (metallic, non-metallic and composite) and sustainable ways of getting and preserving energy in building design. That is one of most important requirements of MSD missions. Considering the high, unique, holistic environmental properties of nature and manmade heritage the model can be realized.

Parameters:

- EC: plain (Vojvodina, northern province of Serbia)
- CC: temperate continental climate (mild to warm summers and cool winters)
- GC: rich with thermal sources
- MC: lot of possibilities
- EcC: stable
- LF: supporting sustainability and eco buildings

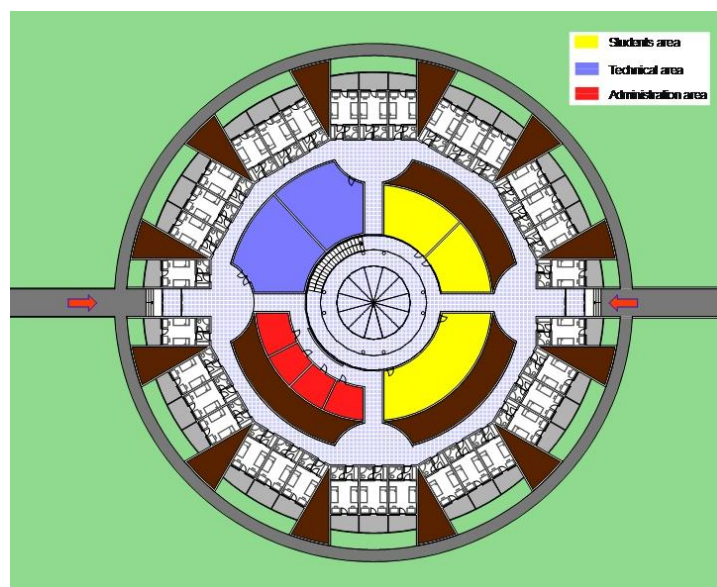
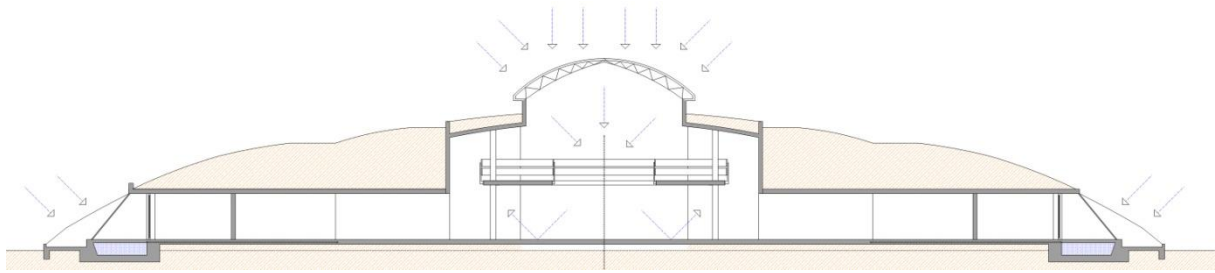

Figure 3. Floor plan

Following all given parameters and demand for innovation we created closed circle. Formative - we started from the ideal circular form (the best form for energy preservation) with a large central hall, which contains a strong zenithal lighting and wide, transparent gallery space, that represents central visual and functional landmark of the building. Around this landmark are radially develop all necessary communications, administrative and technical facilities, reading room and mini gym. Large semicircular corridors outside rooms are provided with vertical pipes diameter 80 cm for lighting and ventilation and are related to the "central nerve system of the building." The building is fully equipped with sensors connected to a central control point, a computer facility so that the same beside for the control can be used in educational and research purposes. The final circle to the outside is closed with blocks of 3 double bedrooms, 34 overall in the engineering module 360/600 cm, which enables the connection of two units for study and life of married couples. The whole facility is designed so that the maximum distance from the entrance and exit (fire conditions) is 25 m. Both entrances are equipped with dual sensor sliding doors (windshield), and the whole electronic system of the building (and keeping control) is provided with auxiliary power unit.



*Figure 4. Section*

Constructive - the basic construction is made of the non-reinforced concrete (with possibility to use recycled materials depending of their availability) with a vaulted ceiling area (by blocks of rooms). The central hall is upgraded from the carrier frame of laminated wood and glassed like glassed terrace areas. All used thermo and hydro isolation materials are from certified materials according to European standards. In this regard it is important to emphasize that all the terraces in front of the room are glassed with five-chamber profile in the Al-frames, and with storage space for placing rocks (secondary solar energy). In the embankments of earth above the facility are secured and electronically controlled concrete water tank for collecting rainwater and watering green areas, including performance of water recuperation on the possible levels.

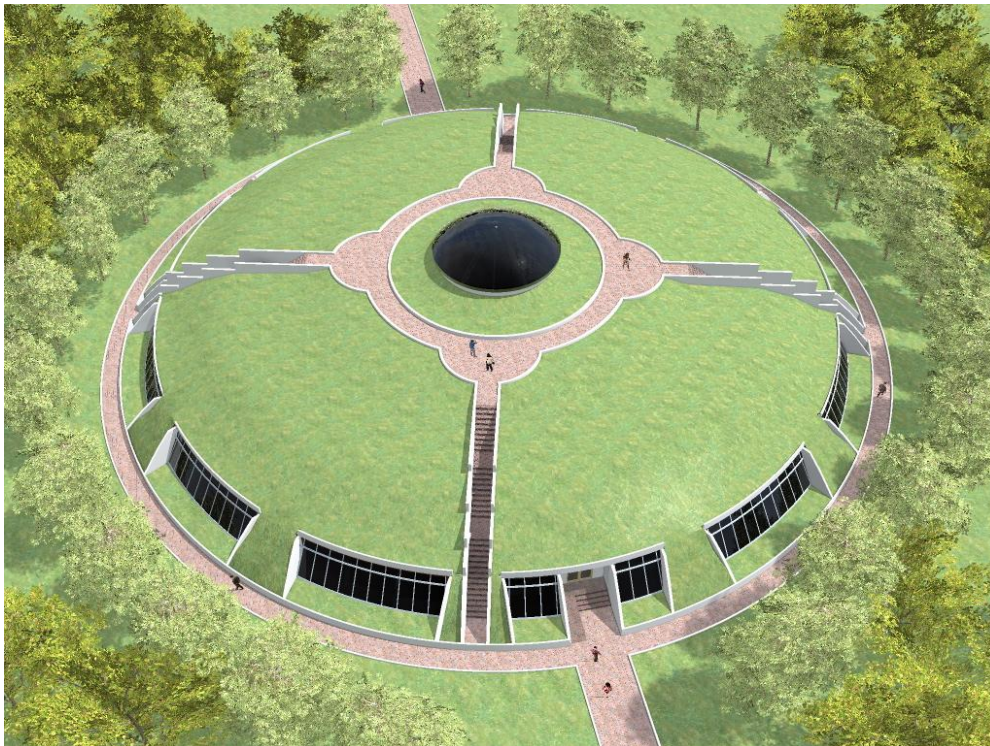

*Figure 5. 3D model*

## CONCLUSION

Creating this kind of dormitory-students housing requires interdisciplinary and innovative approach. Ideally the best age for influencing people indirectly is between 8 and 25 years, but because young people don't get sense for money (earning and spending) in early ages it is then recommended for people age from 18-25, which is in correspondence with students age in Serbia. That is one of the reasons this project is based on students.

Idea to give all dorm inhabitants insights in cheap and sustainable way of living is accomplished by making them pay for energy they consume (same principle-pay what you use, is already applied with success in China at Shanghai Jiao Tong University). This way users of dormitory will pay for water (both hot and cold), heating and cooling and electricity. It is calculated that bills for this kind of object should be around 30% from regular bills for rums same size in old non sustainable buildings.

Other advantages beside cheaper bills are reflected in specially created environment for students with best possible psychological and physical parameters. By giving students chance to live in sustainable dormitory we are changing their consciences to environment friendly. It is expected that when they leave this kind of eco and sustainable way of life that they will be unhappy with current housing and that they will start demanding from building investors to meet with their wishes. With this circle will be closed and better and safer future can be ahead us.

## REFERENCES

- The UK Government Sustainable Development Strategy*. Great Britain: Stationery Office, 2005. Print.
- Craik, Fergus I.M. and Ellen Bialystok. "Cognition Through The Lifespan: Mechanisms Of Change". *Trends in Cognitive Sciences* 10.3 (2006): 131-138. Web.
- Janacek K, Fiser J, Nemeth D. The Best Time to Acquire New Skills: Age-related Differences in Implicit Sequence Learning across Human Life Span. *Developmental Science*. 2012;15(4):496-505. doi:10.1111/j.1467-7687.2012.01150.x.
- Šunjević, M., Vojinović-Miloradov, M., and Reba, D. "SUSTAINABLE BUILDING DESIGN AND ENVIRONMENT". *The 22Th International Scientific Conference "Engineering For Environment Protection – TOP"*. 2016. Print.

**DEVELOPMENT OF URBAN ECOLOGY THROUGH  
EDUCATIVE AND INFORMATION ACTIVITIES**

V International Conference  
„ECOLOGY OF URBAN AREAS“ 2016

**SIGNIFICANCE AND ROLE OF INFORMAL PRACTICAL  
EDUCATION OF SCHOOL POPULATION AS A FACTOR FOR  
DEVELOPMENT OF URBAN ECOLOGY**

**Neda Nikolic, Vladan Paunovic\*, Aleksandar Dragasevic**

University of Kragujevac, Faculty of Technical Sciences Cacak, Serbia  
neda.nikolic@ftn.kg.ac.rs, vladan.paunovic@ftn.kg.ac.rs, aleksandar.dragasevic@ftn.kg.ac.rs

**ABSTRACT**

*The paper emphasizes the importance and role of informal practical education of the school population as a factor of development of urban ecology. The survey was conducted in a primary school „Milan Blagojević” Lučani, whose results were discussed in support of the effort to start important education of children in this area. Considering the results of the survey and the five-year contribution to the practical education of children in the field of environmental protection, especially recycling, it can be seen that the continuous educational project, and implemented in makeshift conditions, brought significant results. It is necessary, first of all, to introduce additional training of human resources dealing with the cases to preserve the environment, and then, children and the population. This requires the support of local government and professional approach to its implementation. As the solution proposed measures for the implementation of this program such as the introduction of environmental education and the system of small subsidies for raising environmental awareness.*

**Key words:** urban ecology, environmental protection, environmental education.

**INTRODUCTION**

In the contemporary society, students are provided many educational opportunities in the field of ecology and protection of the environment they are growing up like a quick and easily accessible information, knowledge transfer, without time and space limitations. In the age of globalization, every nation is faced with a greater challenge of developing its human resources for the future global society. [Siriwaiprapan S. 2009] Global technological connection unsuspected changed educational opportunities. Susceptibility of education and ease of learning have become greater with the emergence of multimedia content, as one of the resources in contemporary education, expressed through categories (text, sound, graphics, video footage, animation) and subcategories within each of them.

Of course, the education system is first constituted through the school system, which in recent years provides a significant contribution to the education of the youngest population on the subject of urban ecology. Additional education is caused, on one side, by school, while on the other, economic and political system. So, education is not synonymous with school education to the student developing initial interest, it is a much broader concept, because it is made of the whole human life, with a change of ways and methods of learning.

Education can be classified in the following way [Тамиловић С., Вујић В.]:

- general;
- general professional;
- close professional;
- specialized;
- expert.

Observing the education department of environmental protection is an important division in terms of the time. In this respect, we distinguish:

- **Compensatory education**, as its name suggests, serves to compensate failures of those who have not studied the "on time" and is mainly oriented to adults. Problem of omissions in the environmental education of the elderly population is reflected in the current poor state of the environment. Compensating these educational failures in the field of environmental protection, the hardest part of the additional non-formal education. Changing perceptions and habits of formed personality is a challenge whose outcome can not be said with certainty.
- **Intensively education**, which is interesting from the aspect of the environment which is constantly changing, because with this teaching we are able go side by side with the changes. Bearing in mind that the environment is also living area, with live human resources
- **Intencionaly education** has anticipative character, looking to the future and points to future changes. Such turbulent conditions of the environment, the significance for the growth of anthropogenic load, include monitoring and predicting changes. It is important to emphasize migrations from villages to towns in the Republic of Serbia, substantially determine the environmental JLS. The educational process should be adapted to these developments because of environmental education (especially practical) on a new dimension.

Education of students on the development of urban technologies at any school system is a complex task, because it nearly always ask questions the coherence and cohesion of mentors, their behavior, knowledge, creativity, will, on the one hand, and academic organizations and students, on the other hand.

#### **EDUCATION OF CHILDREN OF SCHOOL AGE IN LOCAL COMMUNITIES IN THE FIELD OF DEVELOPMENT OF URBAN ECOLOGY**

There are different approaches and ways of acquiring knowledge. Bearing in mind the presented current situation and the real possibilities of the Republic of Serbia, as well as the specificity of its local governments, environmental education and the development of environmental awareness by the current school education, can be obtained by:

- **additional education** (formal and informal) of pre-school children to older generations;
- **professional development** of human resources which are initiators, leaders and motivators process of environmental protection at the local level;
- A permanent **public informing** the people about the environment.

Education for a sustainable future means examining human systems and relationships in the context of their contribution to or detracton from sustainability... Education for sustainable development comprises formal and informal teaching and learning that enables humans to live in harmony with other human communities, other species and the larger environment. [Tarasova P. N. 2009]

Education of children of school age in the local communities in the field of environmental protection promote the level of quality and environmental characteristics of their development of environment - is confirmed by the research process. Research results show that 93.3% attitude management of local government units (JLS) that additional ecological (informal) education of children contributed to sustainable development of local government. By applying the  $\chi^2$  test has not been established statistical significance between the high percentage of these claims and the size of local government. Correlation analysis of the items in scale showed that there are positive and statistically significant correlation between these statements and opinions of management JLS that development of ecological awareness has contributed to raising the efficiency of management and protection of the environment, and attitude to the ongoing awareness and training of the population on environmental protection can help to solve problems of environmental protection.

Development of a system of practical education of the school population, as an important factor of urban ecology development , must be supported by ecological knowledge. It is not enough formal teaching programs. Non-formal education, with an emphasis on practical training, shows significant

achievements. Further development of the concept causes the formation of ecological knowledge as a relevant tool for understanding and understanding of the relation of movement and skills within each sector of the environment.

## RESULTS OF RESEARCH

Additional education of children of preschool and school age is implemented so that the impact on children is proactive, positive and lifelong. Results of the achievements are, among other things, the criteria and the tests which the children did before and after project implementation. Thus, in May 2011. The project was conducted in a primary school „Milan Blagojević“ Lučani. Starting with presumption that adult children do not have enough knowledge in the field of ecology and recycling, it is necessary as soon as possible to start training, was conducted a survey of students. Four eighth-grade classes (86 students), completed a questionnaire on ecology and recycling. The results speak in favor of efforts to initiate more significant education of children in this area.

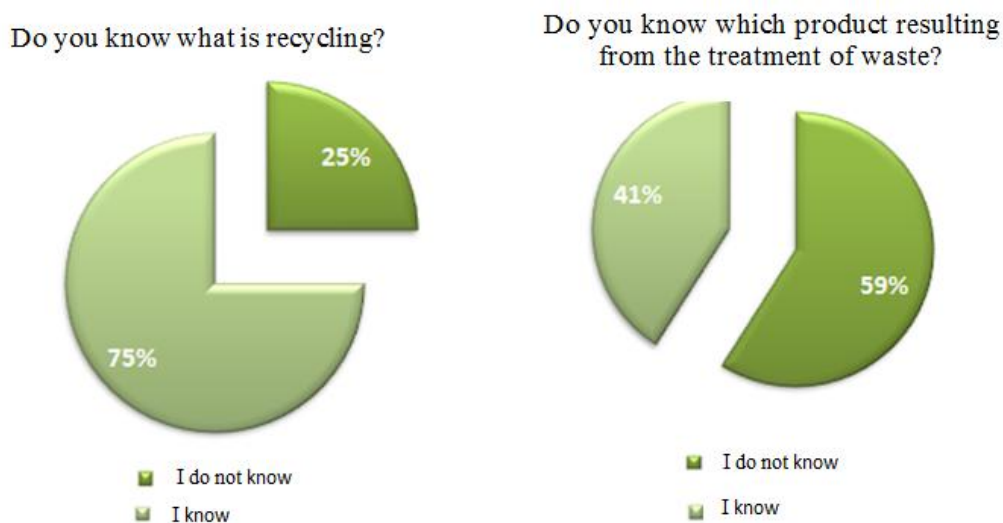

Figure 1. responses of students to questions about the conceptual meaning of recycling in the context of a pilot project for introduction additional training in recycling in the local government Lučani

In the first graph (Figure 1) we can see that much as one quarter of respondents did not know what is the recycling. The second graph shows that even 59% of respondents do not know any products resulting from recycling, which actually means that 75% of those respondents who know what recycling is, a significant number of them do not know specifically what it produced. Children are, therefore, very superficially educated in this area, or are not sufficiently motivated to deals with these issues.

It is a significant fact that 29% of respondents would be worried about waste, but did not know in which way. About waste would concern, regardless of the allowance, 26%, which leads us to the conclusion that at least half of the respondents participated willingly in the education and development of recycling. About 19% of respondents would not be motivated by money, while 26% of their attitude towards waste based on the amount of financial compensation (Figure 2).



Would you worry about waste if you are in this way able to earn pocket money?

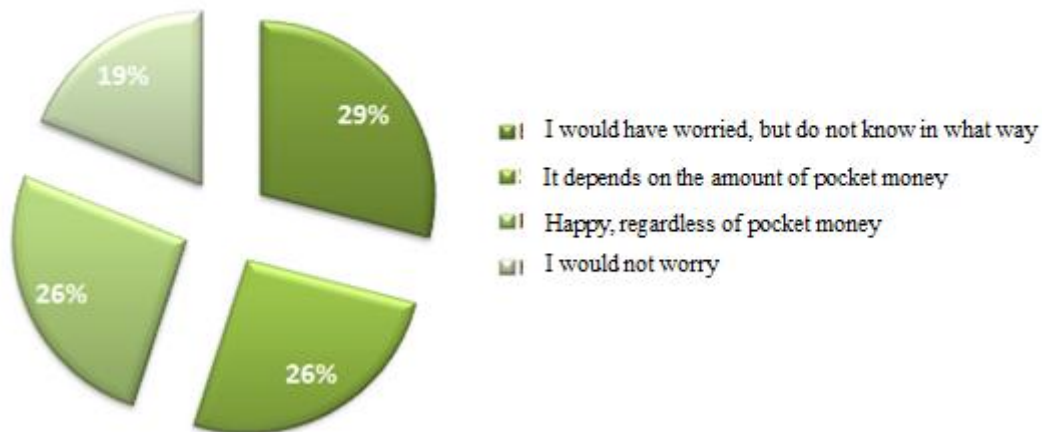
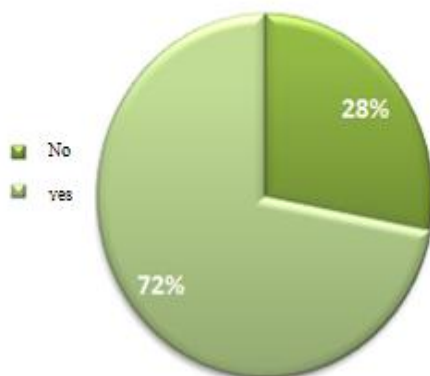

Figure 2. The answer to the question of the pilot project of introducing additional training in recycling in the local government Lučani

Summing up the results of the questionnaire, which were below expectations, and while bearing in mind that these are children who, along with pre-school education, attending classes for almost a decade, have access to the Internet and are determined by education and knowledge of the family, the question arises whether and how ecology and recycling in general represented in the education and lives of children in Serbia, especially in small communities.

All children who participated in the survey were later visited a recycling center SZTR „NEDA PLUS” Lučani, where they met with recycling processes and products which are the result of this process. They actively participated in the separation and selection of waste, familiar with their properties and showed great interest in learning by doing, explaining the visit useful and tangible, unlike previous learning in school. In addition to individual efforts and cooperation with the private school operators, this practical education of children continued in the next years. The success of the practical training of children spurred the desire to further work on their education. This, of course, implies a more serious approach and qualified lecturers. For this reason, in April 2015 in the municipality Lučani was conducted interview of 322 high school students of various directions from the first to the fourth year, in order to determine the results of past work and point to areas that need developed. The survey included various questions of ecology and environmental protection (Figure 3).

Did you have the opportunity to visit the recycling center?



Does the experience during the visit helped them to better understand the waste management procedures and the importance of recycling?

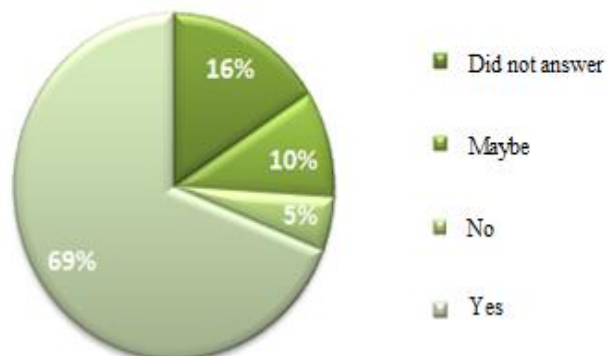

Figure 3. Student responses of secondary school "Dragačevo", local government unit Lučani

Environmental protection refers to?

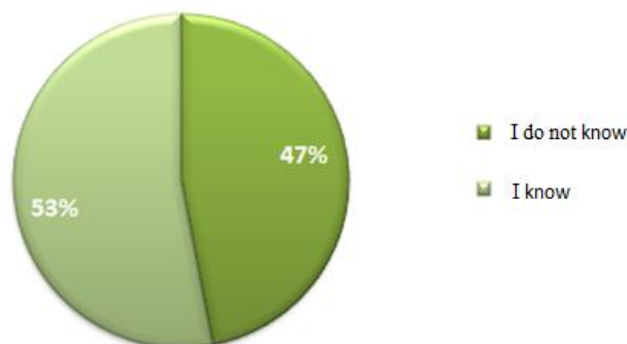

Figure 4. Responses of students to the question about the meaning of concepts of environmental protection

More than half of the respondents knew what it relates to environmental protection. Also, as the ecology is a science that deals with the preservation and protection of the environment, knowledge in this field is a prerequisite for understanding sustainable development. To this question the most of the students gave the correct answer, 78% of them.

Considering the results of the survey and the five-year contribution to the practical education of children in the field of environmental protection, especially recycling, it can be seen that the continuous educational project, and implemented in makeshift conditions, brought significant results. Of course, for the further development and implementation of the strategy presented by the above steps to bridge the gap, it is necessary, first of all, to introduce additional training of human resources dealing with the cases to preserve the environment, and then, children and the population. This requires the support of local government and professional approach to its implementation. Training and education that is much discussed in the previous part of the paper, play a decisive role in implementing clearly defined strategies.

Therefore, environmental protection is in the hands of human resources, their knowledge, skills and will. Further development also requires additional education on sustainable development and its establishment in the minds of citizens. From the the following view can be seen that there is a willingness to acquire new knowledge and faith that the additional training will be contributed to improving the attitude towards the environment.

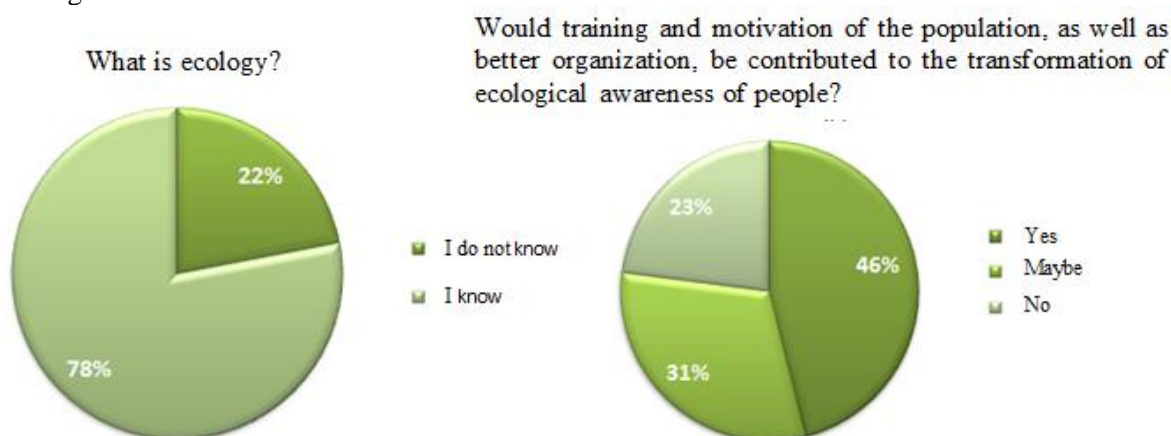

Figure 5. displays the answer to the question of secondary school students "Dragačevo", local government unit Lučani about what ecology and whether education and motivation of the population, as well as better organization, be contributed to the transformation of environmental awareness of people

On the question of whether they consider that the additional training and motivation of the population, as well as better organization of the environment at the level of Lučani, will be contributed to their better and more careful attitude towards the environment, the majority of respondents gave a positive answer. Number of respondents who gave a positive response, the 46% and the number of respondents who gave the answer "maybe" 31%, tells in favor of that, about 77% of respondents have a will and faith that additional education contribute to a better and more careful attitude towards the environment. This is more than a good basis for realization of additional education in the field of environmental protection in the municipality of Lučani be applied in practice. The number of students who do not think that education and motivation of the population give results, amounted to 23%.

## CONCLUSION

The educational process in the context vision and the research topics of environmental protection contributes, without a doubt, the creation of an institutional culture of sustainability, education environmentally responsible citizens, improving environmental literacy for all, involving all stakeholders, ie. personalities, groups, organizations or institutions that can benefit in connection with the very specific organized action in this area - all in order protect the participants in the social environment and accelerate benefit of the quality of life.

The reason for low participation of citizens in environmental education lies in the low living standards and developing mechanisms for citizen participation in the education process. As the solution proposed measures for the implementation of this program, such as the introduction of environmental education and the system of small subsidies for raising environmental awareness.

Therefore all the developing countries must to strive for forming environmental education, whose role is in achieving successful sustainable development strategy . We can say that eco-management project begins by top management, with the implementation of eco-educational strategies and programs implies that the management of local government must give its maximum in human resources management in environmental protection.

## REFERENCES

- Camilovic S., Vujic V. (2007). Osnove menadžmenta ljudskih resursa, Tekon, Beograd.  
Mihailovic D., Ristic S. (2011), Menadzment ljudska strana, Fakultet tehnickih nauka Novi sad.  
Mihailović D., Ristić S. (2005), Timski rad i radni apsentizam, Beograd.  
Robbins P. S., Coulter M. (2005)., Menadžment, Osmo izdanje, Data Status, Beograd.  
Robbins S. (2005)., Organizational Behaviour, John Wiley and Sons, New York.  
Siriwaiprapan S. (2009). Human resources and their development: Global Environment for Human Resources Development Vol I. Oxford, UK: Eolss Publishers Co. Ltd. 1  
Tarasova P. N. (2009). Quality of Human Resources: Education Vol I, Oxford, UK: Eolss Publishers Co. Ltd., 31  
Torrington D., Hall L. & Taylor S. (2004), Menadžment ljudskih resursa, Data Status, Beograd.

V International Conference  
„ECOLOGY OF URBAN AREAS“ 2016

## ENVIRONMENTAL EDUCATION OF PUPILS IN TECHNOLOGICAL AND INFORMATION TECHNOLOGY TRAINING

Ivan Tasić, Jelena Jankov, Marjana Pardanjac, Erika Eleven

University of Novi Sad, Technical Faculty “Mihajlo Pupin”, Zrenjanin, Republic of Serbia  
tasic@tfzr.uns.ac.rs

### ABSTRACT

*Ecology and environmental awareness are becoming the new spirit of the times, and the environmental movement more and more widespread and organized prejudice to the areas with which they, at first, no one has challenged the relationship, such as. economy, culture and education. The aim is to analyze the content of teaching technical and IT education suggest how it could be accomplished environmental education in teaching pupils. The paper studied teaching topics of technical and computer education of 5-8. Class and proposed teaching units that can be extended with the contents of ecology and environmental protection.*

**Key words:** *ecology, environment, education, teaching.*

### INTRODUCTION

Today's civilization was developed on the paradigm of continuous material growth and encourage unscrupulous consumption of natural resources. The consequences are well known. Mankind is entering the third millennium with global environmental problems:

- Damage to the biosphere and its ecosystems,
- The population explosion - by 2040 is expected to be 10 billion people,
- Global climate change,
- Exhaustion of natural resources,
- Waste into insurmountable amounts,
- Damage to human health, etc.

At a time of global ecological crisis, education and upbringing for environmental protection, in addition to timely and credible information, legislation and environmentally justifiable investment, puts as the most important task, since it most directly affects the creation of environmental awareness and ecological behavior. The basic elements of theoretical and empirical acquired environmental awareness are ecological knowledge, evaluation of ecological situation and ecological behavior. At the same time, environmental awareness is not only about knowledge about the relationship between nature and society, the disruption of the ecological balance and the need to protect the environment, but also the conscience, or the willingness of individuals and social groups to engage in such protection and to responsible and environmentally justified to treat the environment in which they live (Pavlović, 2004).

Education of environmental protection should enable the redefinition of man's relationship to nature and change its behavior: the basic condition is respect for the principles of nature. Nature is the source of life that must be protected. But to do this, one must not disturb its balance, diversity and interdependence and great power self-reproduction. The education of environmental protection is not just about exploring the natural and social sciences necessary for understanding and solving environmental problems and environmental pollution, but also assumes extension of moral principles and the formation of a new system of values of man in relation to nature and the environment: a man can and must to be the only users of nature, and not its unlimited master. If nothing else, for my own sake, one must keep in mind that they do not destroy their own environment, and thus itself. Former anthropocentrism must replace bio (eco) centrism.

Before the requirement of such a new relationship to nature, a new philosophy of life and a new model of development is to create environmental awareness and ecological behavior, ie, the development of environmental ethics and environmental culture.

The education of environmental protection, as in Chapter 36 of Agenda 21 (Programme of measures and activities for the 21st century) states in the function of sustainable development and therefore it is necessary for all the inhabitants of the planet and must be long term and planned development of interdisciplinary knowledge about the environment during the entire life of man.

The aim is to develop awareness of the basic characteristics of the environment, the relationships in her and for her, as a precondition of man's aspirations for its preservation and improvement for current and future generations. Therefore, it is in fact necessary to the educational process providing interdisciplinary and multidisciplinary approach in order to learn the essence of relations: society, man, technology, natural environment, and express aspects of environmental integrity, economic, social, technological, cultural and aesthetic content. The contents, methods of presentation and methods of work must aim at the formation of individuals able to participate in making decisions that will be in accordance with the principles of the so-called. maintainable (coordinated) development.

Thinking and learning about the relationship of man and the environment to improve over the centuries. History of education for environmental protection at the international level, in fact, run in parallel with the development of thinking about the environment and sustainable (coordinated) development, as a new philosophy of life, a new view of the world.

For education for the protection of the environment from all international meetings have special importance of the conference in Stockholm (1972), Belgrade (1975) and Tbilisi (1977) Congress in Moscow (1987) Conference in Rio (1992) and Thessaloniki (1997) in which they stressed that education is the key to survival and hence this brand-new education for survival.

At the global level, back in 1975 prepared the first "International Programme of Education for Environmental Protection" (UNESCO and UNEP), and after the Rio Conference in 1993, and amended in order to the reorientation of education of the population on the Planet sustainable (coordinated) development.

The program defines the main goals of education:

- Enabling each individual to gain awareness, knowledge and skills necessary to actively participate in protecting and improving the environment and achieving harmonious development,
- Create a new environment for desirable behavior and lifestyle,
- The development of environmental ethics and environmental culture,
- Strengthening of education for environmental protection for all,
- Improving the quality of life.

## **MANDATORY ECOLOGICAL APPROACH TO THE DEVELOPMENT OF EDUCATION IN SERBIA**

The emphasis for future development of the educational system, from kindergarten to university, must be on efficiency, quality and modernization concept in line with EU commitments and internationally accepted documents.

In the recently adopted National Education Council document on possible directions of education development in Serbia from 2010 to 2020, although a comprehensive and analytical assesses the current situation and indicates the commitment of the school system to ensure each pupil acquiring basic literacy in all major domains of knowledge that should be the basis for a lifelong learning

process, however, ecological literacy is not stated explicitly, although the universal precondition for the survival of humanity on Earth.

The Republic of Serbia, the adoption of the National Strategy on sustainable development and legislation in the field of environment identified for the implementation of education for environment and sustainable development through the formal educational system and professional training, and informal forms of training of the population, because this education as far as possible coincide with the concept of modern education.

### **EDUCATION OF PUPILS**

The world in which we live requires the pupils to a very early start to think about it. The amount of knowledge or information which the individual pupils should be raspolagativno increased over the past hundred years, but it is also the availability of this knowledge much higher than before.

Pupils should point out that the whole universe is a network of interconnected processes / energy so that each man's action has a reaction / result universe / existence. By concentrating on such an understanding of things, pupils are required to understand that they are responsible for the world in which they live.

### **SCHOOL AS A FACTOR OF ECO-EDUCATION**

School is the basic factor of education and eco-education. With the established program contents and forms of school provides the greatest opportunities in building awareness of pupils. It provides significant opportunities for the acquisition of certain knowledge, but also for developing certain habits, to develop environmental awareness by developing love and responsible attitude towards the family.

Basically, our educational system implies a continuous educational process, which is conducted regulatno in institutions intended for this type of activity. Although the education of young people for the protection of the environment has its roots in family education, schools for this purpose becomes indispensable (Kolović, 2008).

How much will be paid to environmental amenities and whether it will be made a correlation between the subjects in the teaching process and the experience and knowledge of pupils, to a large extent depends on the affinity and training of teachers.

Therefore, great attention must be paid to constant professional training of teachers through additional training and seminars. Significantly, the life of the school as an institution involves serious in activities that are organized at the level of the local community and whether there is such kind of cooperation (Jokić, Marjanović, 2009). Modern ecological situation has shown that the knowledge of the ecology is not at the required level. This knowledge in itself does not mean anything, but they have a tremendous educational potential.

### **PROPOSAL TO IMPROVE ENVIRONMENTAL EDUCATION IN TEACHING TECHNICAL AND IT EDUCATION**

In the realization of the technical and IT education in the 5th grade pupils learn the topics:

- Introduction,
- Graphic communications.
- Information technology,
- From idea to realization,
- Materials and technology,

- Energy,
- Constructors modeling,
- Traffic.

In the realization of the technical and IT education in the 6th grade pupils learn the topics:

- Introduction to the architecture and construction,
- Technical drawing in construction,
- Information technology,
- Construction materials,
- Energy,
- Technical means in construction,
- Transport systems,
- Culture of living,
- Constructors modeling – Modules,
- Technical means in agriculture.

In 7th grade pupils are learn the topics:

- Introduction to the mechanical technique
- Technical drawing for mechanical engineering
- Information technology
- Materials
- Measurement and control
- Material processing technology
- Machines and mechanisms
- Robotics
- Energy
- Constructors modeling - Modules

And in the 8th grade pupils learn the topics:

- Information technology
- Electrotechnical materials and installations
- Electrical machines and devices
- Digital electronics
- From idea to implementation – Modules

Among the objectives and tasks related to the ecology of 5-8th grades are as follows:

- Recognize the natural resources and their limited resources;
- Adapt to the dynamic construction (models) the energy source;
- Meet the economic, social, technical, technological, environmental and ethical aspects of work and production, and their importance to the development of society;
- Know the extent of protection and the need for the restoration and improvement of the living environment;
- Introduced the possibility of using solar energy, wind and water;
- Get used to save energy;
- Recognize the natural resources and their limited resources,
- Adapt to the dynamic construction (models) the energy source,
- Acquire the habits of rational use of materials and energy;
- Acquire and develop the culture of living in modern conditions;
- Recognize the limitation of natural resources,

- Learn about the economic, technical, technological, environmental and ethical aspects of work and production and their značaj the development of society, know the extent of protection and the need for the restoration and improvement of the living environment.

From 5-8th grades pupils can talk about the following topics in ecology

In 5th grade:

- Information technology (3rd theme)
- In this issue we can talk about the electrical and electronic waste. On what is this electronic waste, the disposal of e-waste in landfills and recycling of e-Charlotte Stocker.
- Materials and technology (5th theme)
- Here we can talk about the planned cutting of forests, water pollution, recycling of paper, metal, glass, plastic.
- Energy (6th theme)
- Here we can talk about energy resources, on renewable energies,
- Constructors modeling (7th theme)
- Here we can mention the recycling of paper, textiles, leather, augoguma, plastic bags for recycling.
- Traffic (8th theme)
- This topic may draw attention to the pollution of air, water, land.

In 6th grade:

- Information technology (3rd theme) You can talk about the electrical and electronic waste.
- Construction materials (4th theme)
- Here we can talk about the rational use of building materials.
- Energy (5th theme)
- There may be mentioned isolation house, using solar panels for hot water, rational use of electricity (energy saving bulbs).
- Transport systems (7th theme)
- This topic may draw attention to the pollution of air, water, land, hybrid vehicles.
- Constructors modeling - modules (9th theme)
- Creating models from recycled materials.
- The technical means in agriculture (10th theme)
- We can mention the pollution of soil, water, minimize the use of pesticides, human health.

In 7th grade:

- Informatics technology (3rd theme)
- We can talk about the rational use of paper and repeat Sterne children are taught in grades 5 and 6 of electronic waste and recycling.
- Of materials (4th theme)
- We can talk about recycling of metals, iron, bronze, aluminum, copper, brass.
- Processing technology materials (6th theme)
- We can talk about water pollution, according to the country and the environment.
- Machinery and mechanisms (7th theme)
- We can talk about the use of energy efficient equipment.
- Robotics (8th theme)
- One can make a robot from recycled materials. Using robots in the production process can save energy (electricity).
- Energy (9th theme)
- Rational use of energy, existing and alternative sources of energy.



In 8th grade:

- Information technology (Theme 1)
- We repeat what we have learned and do so adding that the transfer of data going through electronics which saves time, energy and money.
- Electrotechnical materials and installations (second theme)
- Recycling conductors, copper, aluminum, light bulbs, recycling electric parts consumers in the household.
- Electrical machines and devices (3rd theme)
- We can talk about alternative energy sources (geothermal, solar, wind).
- Digital electronics (4th theme)
- There may be mentioned e-waste recycling from e-waste can be reused various elements of electronics.
- To the idea to implementation - modules (5th theme)
- From recycled materials to make new products.

## CONCLUSION

The educational work everything related to ecology must be based on an understanding of the relationship between society, nature and culture. Only respect for this attitude will lead to the development of false environmental awareness. Ecological theories and environmental practices should develop participation of wider circle of people who need to understand the ecology as a way of life, to participate in the overall social reproduction and the reproduction of the human environment. Achieving awareness of the actual socioekološkoj middle is the most important goal of education. The education system must train for a wide scope of social needs relating to the problem of the environment and includes a wide range of extracurricular institutions and levels, each of which represents a specific and accountable factor in the unique educational process.

Modern society swung to the educational process-mannered, as compulsory, and elective subjects, and extracurricular activities, in addition to the known principles of teaching, plug and ecological principle. While the man was modest, the environment was not so compromised, so ecological principle, perhaps, was not necessary, but it is at the present time is necessary.

Practice shows that the establishment of adequate knowledge, attitudes and good habits of children and young people the most important role has a primary school. It is extremely important that the ecological principle and the concept of sustainable development are integrated into the curricula of all subjects, for which the pupils will acquire knowledge, what values, attitudes and habits develop largely depends on the achieved goals, objectives and proposed content of the curriculum. It also depends on the content and methods are represented as presented in school textbooks.

The inclusion of ecological principles in the educational process allows pupils to gain habits proper attitude toward nature and the environment and to observe the impact of humans on the environment. Pupils will understand that their role in the protection of the environment is significant, what will motivate them to get involved in the campaign to protect the environment, all of which will result in environmentally desirable behavior.

We can conclude that in spite of the fact that ecology as a separate school subject is not represented in the system of compulsory education, there is continuity in the study of organic content from preschool to the end of primary education. How many organic content will be represented in the election, free and optional activities and a lot depends on the affinity and interest of individual teachers and schools in general.

The area where we live has a favorable ecological situation. Given the amount of pollution and the extent of social problems in other countries in Europe and the world, our space is the "ecological reserve", in which it is possible to achieve beautiful, healthy and sustainable life.

## REFERENCES

- Pavlović, M. (2004). Environmental Engineering. Zrenjanin : Technical Faculty "Mihajlo Pupin"
- Kolović, D. (2008). Ecology as a way of life, Original research papers UDC 502/504: 008
- Savković, A. (2012). Ecological activities around elementary schools, Professional paper, 4. Booking International Conference, Čačak: Technical Faculty
- Jokić, D., Marjanovic, R. (2009). Environmental education to the protection of the environment, 1th International Conference Ecological Safety and post-modern environment, Banja Luka

V International Conference  
„ECOLOGY OF URBAN AREAS“ 2016

## SPECIFICS OF EDUCATION OF LOCAL GOVERNMENT HUMAN RESOURCES FOR THE DEVELOPMENT OF URBAN ECOLOGY

**Neda Nikolic, Vladan Paunovic\*, Aleksandar Dragasevic**

University of Kragujevac, Faculty of Technical Sciences Cacak, Serbia  
neda.nikolic@ftn.kg.ac.rs, vladan.paunovic@ftn.kg.ac.rs, aleksandar.dragasevic@ftn.kg.ac.rs

### ABSTRACT

*The paper discusses the importance of human resources in the environmental protection of local governments for the development of urban ecology. The survey was conducted in the local communities of the Republic of Serbia and points to failures in the current effects and the necessity of professional training of employees in this area. The permanent training of human resources in the field of environmental protection contributes to the quality and sustainability of local government. Environmental education transforms the power and quality dimensions of economic, social and environmental development of local governments.*

**Key words:** *ecological education, human resource, local government.*

### INTRODUCTION

Human resource management, in accordance with the basic principles of environmental protection systems is one of the pertinent challenges, linked to the developmental orientation of economic, social and environmental development of local government. Human resources are a socially responsible factor in protecting the environment from illegal departures and as such hope its sustainability.

Human resource relationship is the "human capital" which is a reflection of their physical, spiritual and emotional characteristics. The result of engaged human resources in the environment at the present way can not be identified with their total resources. Detection, guidance and engagement of hidden human potential in environmental protection represents a challenge.

Human resource management is, with regard to the environment, socially responsible management with the aim to alleviate or eliminate externalities of the environment and support to the creation of a successful sustainable development of local government. This is precisely the reason that the human resource should be upgraded by educational dimension ie. dimension that teaches how to rationally use natural resources, reduce the pollution, management-actions to reach a level of sustainability manipulation of waste etc. The other for changing the system of professional education in the last decade is the change of social and political system in a number of countries [Tarasova P. N. 2009]. Performances of environmental education of human resources are transformed into the force of a new quality of economic, social and environmental development of local government.

Development possibilities of human resource management in the protection of the environment are reflected in:

- *human resources (knowledge, abilities, skills, culture, ethics, social responsibility);*
- *additional environmental education (ecological knowledge within educational facilities is necessary to supplement by non-formal environmental education and training of employees in local governments);*
- *social awareness of the population of local governments in the field of ecology;*
- *the development of environmental awareness.*

The institutions that focus their business support management on environmental protection certainly apply in their practice and management of knowledge, because knowledge is a factor which drives and creates value. Workers need to have higher-order cognitive skills to create and apply new knowledge

to solve problems [Siriwaiprapan S. 2009]. Just as human resources, which in itself continuously design skills and competencies and introduce them into the area of sustainability, able to generate progress in every human activity and hence in the field of environmental protection.

Interactive relationship between the local government unit (LGU) and of the environment is reflected, in addition to the usual pressure of environment, in the impact of the environment on human resource development and thus indirectly on organizational outcomes. Visual map that illustrates causes and the consequences (public / institutional) of human resources management is shown in Figure 1.

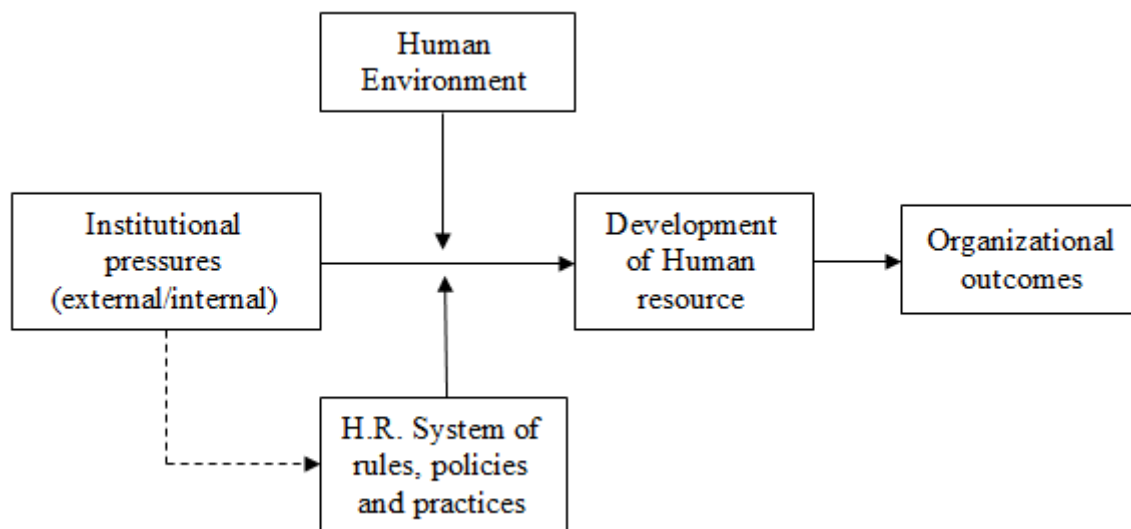

Figure 1. The causes and consequences of (public) human resources management: visual map (modified by: Hans-Jürgen Bruns, 2014)[Bruns, H-J 2014]

The human capital, defined by individual and collective knowledge skills and abilities (KSAS) stresses the importance of intellectual capital as a carrier of modern development aspirations. One of the principles of sustainable development, which promotes the National Sustainable Development Strategy of the Republic of Serbia is the "Knowledge as a factor of development."

## RESEARCH METHODS

The primary objective of this paper is to improve the quality of the environment at the level of local self-government units, using well-designed models of human resources management in the environmental protection.

The scientific contribution of this research is particularly significant, considering that its role is a pioneering, respectively that the subject of this research is orientation in our region is very rare. By it will be filled evident cognitive gap and complemented by the possibility of checking insufficiently verified data of some previous research.

Continuous education of the population of the local communities in the field on environmental protection improves the level of quality and development of environmental characteristics of their environment.

We are aware of the fact that the units of local self-government of the Republic of Serbia are not sufficiently oriented towards innovation related to human resources and the environment. By applying scientific methods was expressed the desire to cover the positioning and understanding of certain actions and decisions of human resource management in connection with the operation of the system of environmental protection on the one hand and future strategy, regarding to the change of a given system on the other hand.

In the projected research is applied is common methodological process of inductive inference. The procedure is supplemented by derived methods of content analysis and case studies. The collection of data placed in the the research project is carried out by the method of testing, as a basic method of research, which is a common phenomena of this nature.

In this study, as the method is applied its most commonly used and most effective techniques - interviewing. The study included 145 subjects of local governments in the Republic of Serbia. The research process was undertaken is appropriate, specially designed instrument-questionnaire, realized technique of individual interview subjects. Attitude of local governments management on the issue of internal characteristics and factors of human resource management JLS is realized by means of a specially designed indoor electronic questionnaire. The questions are divided into groups, and the focus was on the attitudes of top management JLS on the importance of human resources for the environment, their ecological knowledge and the necessity of their training with the employees and the population, the possibilities of improving the environment for new strategic concepts, related to human resources, methods and techniques for efficient management of human resources in the environment and so on.

The procedure of processing the obtained data was performed by using standard procedures and parameters of descriptive statistics and reasoning. Statistical analysis was directed to check the hypotheses based on the statistical significance of differences of obtained indicators.

Further processing was performed using the SPSS software package. For testing the association between variables in the further processing of data are derived parameters correlation (coefficient c and r coefficient) which are tested in a standard procedure for applying  $\chi^2$  test and its significance DF (with a set threshold,  $\alpha$  - usually 0.01 or 0.05).

Table 1: Descriptive indicators of the characteristics of employees scale - display according to individual items

STATEMENTS	The frequency and percentages of frequency						Arithmetic mean	Median	Extent	Min.-max.	Standard deviation
	The degree of agreement / disagreement					$\Sigma$					
	1	2	3	4	5						
	$\phi$ %										
1. Employees in local government do not have sufficient knowledge in the field of environmental protection.	<b>10</b>	<b>24</b>	<b>24</b>	<b>40</b>	<b>7</b>	<b>105</b>	3,1	3	4	1-5	1,123
	9,5	22,9	22,9	38,1	6,7	100					
2. Knowledge of environmental protection of employees in local self-government should be improved by additional education.	<b>0</b>	<b>0</b>	<b>2</b>	<b>39</b>	<b>64</b>	<b>105</b>	4,59	5	2	3-5	0,532
	0	0	1,9	37,1	61	100					
3. Employees in local government would like to improve their knowledge on environmental protection.	<b>0</b>	<b>2</b>	<b>24</b>	<b>27</b>	<b>52</b>	<b>105</b>	4,23	4	3	2-5	0,869
	0	1,9	22,9	25,7	49,5	100					
4. Employees in local self-government would mastered their knowledge on environmental protection by more education, if this were additionally paid.	<b>11</b>	<b>13</b>	<b>18</b>	<b>29</b>	<b>34</b>	<b>105</b>	3,59	4	4	1-5	1,335
	10,5	12,4	17,1	27,6	32,4	100					
5. Employees in local government are not motivated enough to improve the environment.	<b>12</b>	<b>22</b>	<b>17</b>	<b>35</b>	<b>19</b>	<b>105</b>	3,26	4	4	1-5	1,294
	11,4	21	16,2	33,3	18,1	100					
6. Knowledge transfer of employees from the field of environmental protection of the population would be valuable.	<b>1</b>	<b>1</b>	<b>6</b>	<b>35</b>	<b>62</b>	<b>105</b>	4,49	5	4	1-5	0,735
	1	1	5,7	33,3	59,0	100					
7. Former effects of environmental protection are not satisfactory due to the lack of professional training.	<b>7</b>	<b>22</b>	<b>19</b>	<b>30</b>	<b>27</b>	<b>105</b>	3,46	4	4	1-5	1,264
	6,7	20,9	18,1	28,6	25,7	100					

## RESULTS OF RESEARCH

The survey was conducted in the Republic of Serbia, in the period from March to June 2015, on a sample of the predicted  $N=145$  subjects - local government units, which was reduced to  $n=105$  respondents (returned questionnaires was 108; the number of respondents who responded to the questionnaire in a very appropriate way was 105; the number of invalid questionnaires was 3). Number of 105 respondents, which makes 72.41% of the total number of respondents ( $N = 145$ ), it is sufficient, according to statistical postulates, processing and drawing valid conclusions of the research process.

From the Table 1 we can conclude that the top management of most local governments predominantly expresses the position that it knowledge on environmental protection of local government should improved by additional education (98.1% of respondents are in accordance). At the same time, 75.2% of management of local governments feel that there is a willingness among employees to improve environmental knowledge, while only 2% do not agree with this statement. Interestingly, the top-managers believe that the willingness of employees to further their knowledge does not depend so much on monetary compensation: frequency of agreement on this point (statement no. 4) is lower compared to the previous item (60%), while the level of disagreement is noticeably higher ( 23%). In terms of employee motivation for improving environmental protection, attitude of 52.4% managers JLS is that employees are not motivated to improve environmental protection, while 32.4% believe that employees are not motivated enough in this regard. Also, there is a dispersion of views on the issue of cooperation between local governments with the population, although a significant percentage of respondents, 49.5% are not satisfied with the cooperation so far.

Attitudes of the respondents on the issue on relations of unsatisfactory state of the environment and the lack of skilled personnel also vary. Even 38.5% of respondents do not share the opinion that the current state of the environment, due to a lack of professional staff, while 36.2% of them consider that it is the result of lack of professional staff. In terms of importance of knowledge transfer staff on environmental protection to individuals, executives JLS almost unanimously agree - 92.3% of management of the local government believes that it would be valuable and significant. Respondents are also very common in the attitude that the transfer of knowledge of employees in the field of environmental protection can help local government to improve its performance in environmental protection (94.2%).

*Table 2: Mutual correlation of the items on the scale of employees characteristics*

	1	2	3	4	5	6	7
1. Employees in local government do not have sufficient knowledge in the field of environmental protection.	1	.420**	-.279**	.373**	.274**	.072	.423**
2. The knowledge of environmental protection of local government should be improved by additional education.		1	.059	.330**	.169	.317**	.210**
3. Employees in local government would like to improve their knowledge on environmental protection.			1	-.283**	-.250*	.050	-.131
4. Employees in local government would mastered their knowledge on environmental protection by more education, if this were additionally paid.				1	.557	.097	.283**
5. Employees in local government are not motivated enough for improvement of the environment.					1	.009	.257**
6. Knowledge transfer of employees in the area of environmental protection would be valuable.						1	.173
7. Until the present the effects of environmental protection are not satisfactory due to the lack of professional training.							1

$N=105$ ,  $p < 0,01$  \*\*,  $p < 0,05$  \*

We performed a correlation analysis of the items in the scale Characteristics of employees. In the Table 2 are indicated all correlation coefficients that are statistically significant at the significance level of 0.05 and 0.01. A high positive correlation was observed with the attitude that employees in local governments do not have sufficient knowledge in the field of environmental protection and attitude on the method of their advancement additional education ( $r = 0.420$ ). Interestingly, the high correlation is expressed between this paragraph and attitude 7 by which the effects of the protection of the environment are not satisfactory, due to the lack of professional training ( $r = 0.423$ ). Based on this correlation analysis is noticeable attitude of top management JLS that the insufficient knowledge of employees must be improved by training and education of employees.

In a further research method were also detected high positive correlation observed between the variables relating to the desirability of transferring knowledge of employees in the field of environmental protection ( $r = 0.764$ ) and those relating to the unsatisfactory effects of this protection, because of the lack of skilled staff and training employees ( $r = 0.673$ ).

## CONCLUSION

Education is gaining importance in accordance with the progress of human resources and increase of quality of life, which is some kind of a key to success in ranking of development affiliations. Training of employees in area of environmental protection creates a strong basis for new, successful paths of development of local governments. Environmental education transforms the power and quality dimensions of economic, social and environmental development of local governments.

Since the local government team contributes to the quality of life of its citizens and their environment, each employee must have a broad knowledge in the field of ecology.

Environmental protection requires today of local government in the field of human resource management a new way of thinking and working, ie. manner which causes high individual, group (team) and organizational performance. For human resources is relevant possession and sustainability of knowledge, since there is no strategic thinking without mastering in the usage of knowledge management.

## REFERENCES

- Bogicevic, B. (2004), Menadžment ljudskih resursa, CID: Ekonomski fakultet, Beograd.
- Bruns, H-J (2014). HR development in local government: How and why does HR strategy metter in organizational change and development?, Business Research 7:1-49.
- Mihailovic D., Ristic S. (2011), Menadžment ljudska strana, Fakultet tehnickih nauka Novi sad.
- Mihailović D., Ristić S. (2005), Timski rad i radni apsentizam, Beograd.
- Robbins P. S., Coulter M. (2005)., Menadžment, Osmo izdanje, Data Status, Beograd.
- Robbins S. (2005)., Organizational Behaviour, John Wiley and Sons, New York.
- Siriwairapan S. (2009). Human resources and their development: Global Environment for Human Resources Development Vol I. Oxford, UK: Eolss Publishers Co. Ltd. 1.
- Tarasova P. N. (2009). Quality of Human Resources: Education Vol I, Oxford, UK: Eolss Publishers Co. Ltd., 28.
- Torrington D., Hall L. & Taylor S. (2004), Menadžment ljudskih resursa, Data Status, Beograd.



## **ICT IN THE ECOLOGY OF URBAN AREAS**

V International Conference  
„ECOLOGY OF URBAN AREAS“ 2016

## SMART HOMES AND SECURITY ISSUES

Ana Štajminger<sup>1</sup>, Josip Naglič\*<sup>2</sup>

<sup>1</sup>NTNU Gjøvik, Sustainable Manufacturing student, Norway

<sup>2</sup>Natural Science and Graphics School, Rijeka, Croatia  
*ana.stajm@gmail.com, josipnaglic@gmail.com*

### ABSTRACT

*The increasing popularity of the 'smart homes' which utilizes the idea of Internet of Things, creates the space for security breaches and frauds. In post-Snowden era, the public has been rightfully concerned about the mechanisms behind the operations which 'make life easier.' Because the average citizen is not well informed about the decisions he/she is making in the digital world, he/she thus has a communication barrier. Such is the case with the deaf community in hearing world. By making a comparison between a non-informed user of 'smart' appliances (such as 'smart benches') and a deaf user in everyday situations, the paper points to the security issues which are a part of sustainable solutions, especially in urban areas.*

**Key words:** *smart homes, security, privacy, Internet of Things, literacy.*

### INTRODUCTION

Smart homes are becoming the new standard of living, as "68 percent of Americans are confident smart homes will be as commonplace as smartphones within 10 years" (Klein 2015). Smart homes are just an upgrade of the new trend with the prefix 'smart', which in most cases means collecting and exchanging data for the purpose of improving the enjoyment and cost of living. The improvements are so far reaching that they could not just enhance the lives of the few, but solve some important economical and security issues that a state alone could not do so far.

However, because smart homes are rapidly networking in another new trend called Internet of Things (IoT), and connected among each to form smart communities, this raises the security issues over the reliability of these connections. Connections that have improved our lives in the past like telephone and Internet have been under manipulative attack, for the purpose of financial or security gain. The Snowden case has shown the lack of knowledge of technology being used, with figures showing more than one-fifth of American adults "22 percent — say they have changed their use of various technology tools 'a great deal' or 'somewhat' since first learning about the Snowden leaks, which began in 2013" (Hesseldahl 2015).

This paper aims raising at least some awareness of the issue. There already exists a corpus of critical literature of the smart solutions and the privacy/security issues. Some papers are more technical, some are less – this one is less, but cites some technical solutions in order to argue the point. The paper continues as follows: after presenting the benefits of smart homes, it presents the problems, before offering possible solution. This solution mostly consists of raising the digital awareness and literacy of smart home users and general population.

### SMART SOLUTIONS

Before moving further, it will be useful for the sake of the argument later on to briefly go over the terms involved and the history of the field.

#### The terminology

The term 'smart solutions' that was used above seeks to encompass smart phones, smart homes and smart communities. If 'smart home' may be a new term, 'smartphone' is already widely used, meaning

a phone which combines features of personal computer and phone, or a “complete operating system (OS) software that provides a standardized interface and platform for application developers” (Phone Scoop).

'Smart home', further on, is a home which collects data on of its users or inhabitants and "adjusts its functions to the inhabitants' needs according to the information it collects from the inhabitants, the computational system, and the context" (Koskela, Väänänen-Vainio-Mattila 2004: 234). It should also be pointed out that "this kind of intelligent environment, information processing and networking technology is hidden away, and interaction between the home and its devices takes places via advanced, 'natural' user inter-action techniques, such as speech" (Koskela, Väänänen-Vainio-Mattila 2004: 234) – this will be crucial later on. (Note the use of word 'intelligent environment' – these homes are sometimes called 'intelligent homes' and the group of such connected homes are 'smart community' or 'intelligent community' (e.g. Kumar 2014)).

All this is just the last phase of the development started some half a century ago: "... in the late 1960s, communication between two computers was made possible through a computer network. In the early 1980s, the TCP/IP stack was introduced. Then, commercial use of the Internet started in the late 1980s. Later, the World Wide Web (WWW) became available in 1991 which made the Internet more popular and stimulate the rapid growth. Then, mobile devices connected to the Internet and formed the mobile-Internet. With the emergence of social networking, users started to become connected together over the Internet. The next step in the IoTs is where objects around us will be able to connect to each other (e.g. machine to machine) and communicate via the Internet" (Kumar 2014: 20).

In other words, a smart home is filled with "devices [that] sense and record user activities, predict their future behavior, and prepare everything one step ahead according to the user's preference or needs, giving him/her the most convenience, comfort, efficiency, and security" (Li et al, 2011: 68). The ultimate goal of IoT is to create – "with minimum human intervention" – "a better world for human beings" (Kumar 2014: 20).

### **The benefits**

An introduction to smart homes written a decade ago (then already in 3rd edition), lists the reasons for using smart homes: access the Internet from anywhere in your house, remotely control your home, save time, save money on communications costs, save money on your home expenses, save money on the future, etc. (Briere, Hurley 2007: 18-19). All of the mentioned have mostly one thing in common: saving time and money. A pretty smart way of living.

However, let us take a look at the big benefits of smart living, not just the family budget. Given the urbanization, declining birthrate, population aging, etc., the medical staff is often either in shortage or unavailable in rural areas, and together with prevention programs "health of the citizen becoming heavy burden on economy, individuals, families and state" (the example is from Kumar 2014, 22).

Smart home, however, can "can collect human body medical information timely through a variety of body medical sensors loaded in the human body or surrounding space and extract useful information by data encryption, storage, comparative analysis and processing" and when "abnormal appearance is found, users are notified to take early treatment; this enables the early detection and prevention" (ibid.). Not only that, but "establish national health management records, to provide prevention and decision-making basis for lifestyle diseases, epidemic and regional disease through monitoring, comparing analyzing and processing healthcare information of associated group" (ibid.). In this way, without much politics involved, "capabilities of disease prevention, early detection and early treatment are improved enormously" (Kumar 2014, 22).

Also, given that "over a billion people including children (or about 15% of the world's population) are estimated to be living with disability" (Domingo 2012: 584-5), and "the employment rate was 44% and 75% for people with and without disabilities, respectively" (Domingo 2012: 585), all goes in favor

of alternative solutions. One such is RFID-based assistive device, which helps blind people in an unfamiliar area: "RFID tags are distributed through the area. They can for example be placed in the center of the sidewalks to orient the blind person and prevent possible falls near the border of the sidewalk" (Domingo 2012: 586). Or, in detail: "The RFID cane has a tag reader with an antenna that emits radio waves; the tags respond by sending back their stored data, hence identifying the location of the blind person. The tag reader (RFID cane) transmits via Bluetooth or ZigBee the data read from the RFID tag, which includes the tag ID string. This data is sent from the monitoring station through the network layer to the RFID server of the application layer. The blind person can record the destination's name as a voice message using the monitoring station. Directions are received by the monitoring station and played as voice messages" (ibid.).

Let me cite just another example of the use of IoT and disability. A deaf person in educational setting is often a debate with a Gordian knot, with very few articles going beyond the traditional stands and offering technological solutions (see Stajminger 2015). Here is a perfect example of this: "RFID-tagged toys are used to help deaf kids ages three to four learn how to use sign language. The software developed enables a child to use a RFID reader to scan an item's tag, capture the unique identifying number and send it to the computer's software via the USB connection. An animation is launched, which includes videos of a person and of an avatar signing that item (in American Sign Language (ASL)) as well as several pictures of the item to familiarize the child with the many versions of the object (e.g. multiple types of ships). The concept is also shown in written English for a bilingual approach to language acquisition. The system was integrated into the early childhood curriculum at the Louisiana School for the Deaf for four weeks to determine its impact on vocabulary acquisition, and the results were positive" (Domingo 2012: 590-1). (There are more examples with detail explanation behind some solution for the disabled in this excellent study by Mari Carmen Domingo.)

The last example is on neighborhood security, namely, Neighborhood Watch, "involving a group of residents devoted to crime and vandalism prevention within a neighborhood" (Li et al, 2011: 71). However, because "unavailability, tiredness, distraction, and limited perception, human-dominated neighborhood watches are inconsistent and of limited effectiveness" (ibid.), which is why "smart community environment provides a perfect platform to implement unattended and pervasive always-on neighborhood watches, saving human resources and increasing effectiveness and efficiency" (ibid.).

On the other hand, homes have cameras which "continuously monitor the surroundings of their corresponding homes, including not only the homes' yards but also nearby road/street segments" (ibid.). In detail, it can be "abstracted as computationally capable sensors with limited sensing range, and the community network is therefore a wireless sensor network covering the geographic region of the community. Homes cooperatively and distributedly detect suspicious events, and decide whether a detected event is a safety threat; when necessary, they inform other community members within the event interference range and/or contact the call center. Meanwhile, they report the event to the community center, where all the event reports are gathered and analyzed." (ibid.)

However, one thing was worth noting, which was mentioned earlier, that this solution seeks to make life easier "with minimum human intervention," and in this example authors say that such "community center determines the correlation of received event reports (data) by statistical approaches" (ibidem, 72). And if "together, they indicate a community-wide threat, it sends alarms to all the homes in the community as well as contact the call center" (ibid.). Another thing worth mentioning is "that the monitoring objects of neighborhood watches are events happening in the public space. Other events take place on private property and are taken care of by individual home security systems" (ibidem, 71-72). Similar responses can be taken for fires, earthquakes, etc.

### **The problems**

Some problems are of technical nature. For instance, Domingo cites challenges on wireless embedded devices, such as "Battery-powered wireless devices require low duty cycles, whereas IP is based on always connected devices" (Domingo 2012: 587). Some are only partly technical, as in the case of the

mentioned neighborhood surveillance: "When the number of reports is beyond a certain threshold, it notifies the corresponding homeowners by other means such as an automatic telephone call. *The homeowner is responsible* for investigating and fixing the problem quickly and reporting the repair to the community center, which then informs the entire community so that those home gateways can be reused for routing" (Li 2011: 71, our emphasize).

In a word, smart homes may be seek to be "with minimum human intervention", but they are not *without* human intervention. Second example is even more important because it involves the security not just of one home, but of a community also.

Another example is about personal healthcare information (PHI), because the "residents' PHI is transmitted in the community network, exposed to unauthorized collection, disclosure, or other inappropriate use, and constituting privacy threats to those residents" (Li et al, 2011:73). For instance, "if an observer knows that a resident often sends his/her PHI to a particular healthcare worker, then based on the medical treatment domain of the healthcare worker, the observer can correctly guess that resident's disease with a high probability" (ibid.). These and similar issues may be "resolved by cryptography, packet re-encryption, and mix techniques" (ibid.). However, this only covers part of the concerns, because "[i]mproper design and disclosure of the policy would enable partial information of the communicating parties to attackers, and thus violating user privacy" (ibidem, 74). Something an average user should be aware of. But what is an average user?, one might say.

## **THE LANGUAGE BARRIER**

Vaguely as it seems, the average user may be defined as the one who uses the technology without understanding the mechanism behind it. For instance, most people who search the Internet often find themselves clicking "OK" to a message popping up on the screen, that reads something like this: "This website uses cookies to improve service and provide tailored ads. By clicking OK or using this site, you agree to this use. Learn about our Cookie Policy" (with the last phrase being a hyperlink to the page on the policy in question). Not many people, though, can explain what these "cookies" are, and do not thoroughly read the policy (nor understand the often too legal jargon).

This, however, does not stop the visitors of these pages from using the content or technology behind it. The same can be told of users of traction control system in vehicles or auto zoom in digital camera. On the other hand, the most vehicles or digital cameras do not send any data out from a vehicle or a camera (smartphones not included). Which brings us to the point.

A non-informed user is acting like a deaf person in a hearing world. Because the first language of congenital deaf is not a word, but a sign, this often makes them the most discriminated minority (because their disability is communication, which means that they are "discriminated in school, on the job, and in gaining access" – Lane 2005: 296). Which does little harm when a deaf person wants to order an ice cream among the hearing people, but but can have big repercussions when the same person wants to order a dress, by clicking OK to paying something online or synchronizing the accounts. Even worse, having a third party do that for them – which is precisely the trend of the industry.

As one author explains: "When smart home companies first launched, they didn't have access to nearly as much user data as they have today. Now, flooded with an abundant amount of information on user activity, preferences and goals, IoT companies are turning this data into notifications to give users as many insightful tips as possible" (Klein 2015). This "information overload", he says, leads to more activity from IoT company, which "will need to organize, prioritize and streamline data – and then present it properly" (ibid.). Note that organizing, prioritizing and streamlining of the data is *not* done by the user. (It is also worth noting that "security and the protection of privacy is not a matter to be addressed exclusively by a legislator," says one author, adding "Research and development in the field of information technology should also consider ethical consequences of new inventions" (Weber 2010: 28).)

Without the knowledge of the things we are agreeing to, what is the difference between a deaf person and a non-informed one? A big issue therefore is the need for a change of the definition of literacy (often described simply as an ability to read and write) and consequently education (for more see Štajminger 2015, Buckingham 2006).

## **DIGITAL LITERACY**

The answer to this issue is that a smart home user, just like a smart phone user, should know the basics of the technology. Arguably, “the basics” is not an easy thing to define, as many introductions tell us. Or, in other words: "First, what do they call these new skills that are evidently required to function adequately in today's society? Second, how can these new skills be taught? And third, who is best placed to deliver these skills?" (Belshaw 2011, 19).

There have been many attempts to define "digital literacy", and in one good analysis an author points to "inconsistency" because "some restrict the concept to the technical aspects of operating in digital environments, while others apply it in the context of cognitive and socio-emotional aspects of work in a computer environment" (Eshet-Alkalai 2004: 103). Although we do not give a definite answer to a digital, IoT or smart literacy, we are stressing the importance of it.

Nevertheless, a smart home user should be aware of at least two things. First, that the devices that are part of smart solutions do *collect* data which is the user's activity, as we have seen, in order to "predict" and "prepare." Unlike other appliances that give the service in a way that was imagined, programmed and manufactured in the year it was produced and sold, the smart appliances are in a way still being manufactured and improved on a daily basis. To insist on the least possible amount of information that should be stored or collected is the exact opposite of the smart solutions concept. It is like asking a psychiatrist to help, but only to remember as little as possible and not to ask so many questions. The 'smart' in smart solutions *depends* on the data collected. In that sense, the same thing that is a blessing is also a curse – a pattern. "In a familiar environment," one paper points out, "human behavior assumes certain regularities. Doing everyday chores often turns into chains of action, which assume patterns, such as doing the laundry at a particular time and in a particular place and way ... these chains of action occur in various action centers. In this study, we found that, in particular, families with children and the elderly had established activity patterns. (Koskela, Väänänen-Vainio-Mattila 2004: 236). It seeks "to maximize inhabitant comfort and minimize operation cost. In order to achieve these goals, the agent must be able to predict the mobility patterns and device usages of the inhabitants" (Das et al, 2000: 77).

Which leads us to the second issue, perhaps the most important thing of living in a smart home: the awareness that this home now goes beyond its constructed nature. Or, as Michael Seeman says: "we used to have walls and distances—in the ‘old game’ privacy was not just a right, it was the default setting. It took a lot of effort to bring information to someone outside the room in which you were speaking. Now things have changed dramatically and it is the other way around – you have to make a great effort NOT to distribute information all over the world" (Seeman, Lilly 2015).

Therefore, no matter how much trustworthy the other party is – even in the case of police department or hospital – it involves data exchange which can be manipulated.

## **CONCLUSION**

We are aware that this puts the pressure on the consumer to be informed. But we do not hold that the consumer – an inhabitant of a smart home or community – nor a provider or any other party involved is solely responsible (for legal issues see Weber 2010). We argue for prevention, instead of a blind trust. Just like an ordinary citizen does not have to be a legal expert, he should not be a naive, law-abiding citizen.

## REFERENCES

- Briere, D., Hurley, P. (2007), *Smart Homes For Dummies* (3rd Edition), Wiley Publishing, Inc.
- Buckingham, D. (2006), "Defining digital literacy", *Digital Kompetanse*, 4-2006, Vol. 1.
- Das, S. K., Cook, D. J., Bhattacharya, A., Heierman, E. O. III, Lin T. (2002), "The role of predictional algorithms in the MavHome Smart Home Architecture," *IEEE Wireless Communications*, December 2002.
- Domingo, M. C. (2012), "An overview of the Internet of Things for people with disabilities," *Journal of Network and Computer Applications* 35 (2012).
- Eshet-Alkalai, Y. (2004), "Digital Literacy: A Conceptual Framework for Survival Skills in the Digital Era", *Jl. of Educational Multimedia and Hypermedia* (2004) 13(1).
- Hesseldahl, A. (2015), "Snowden Leaks Have Changed How Americans See Their Privacy," <http://www.recode.net/2015/3/16/11560290/snowden-leaks-have-changed-how-americans-see-their-privacy>
- Klein, C. (2015), "2016 predictions for IoT and smart homes", <http://thenextweb.com/insider/2015/12/23/2016-predictions-for-iot-and-smart-homes/#gref>
- Kumar, J. S. (2014), "A Survey on Internet of Things: Security and Privacy Issues", *International Journal of Computer Applications* (0975 – 8887).
- Lane, H. (2005), "Ethnicity, Ethics, and the Deaf-World," *Journal of Deaf Studies and Deaf Education*, 10:3 Summer, Oxford University Press.
- Li, X., Lu, R., Liang, X., Shen, X., Chen, J., Lin, X. (2011), "Smart Community: An Internet of Things Application," *IEEE Communications Magazine*, November 2011.
- Phone Scoop, <http://www.phonescoop.com/glossary/term.php?gid=131>
- Seeman, Michael and Lilly, Adriene (2015), "Digital tailspin: rules for the internet after Snowden", <http://podacademy.org/podcasts/digital-tailspin-rules-for-the-internet-after-snowden/>
- Štajminger, A. (2015), "Deaf and Technology: Lesson from a Deaf Student", *Academic Research of SSaH* 2015, Prague.
- Weber, R. H. (2010), "Internet of Things – New security and privacy challenges", *Computer Law & Security Review* 26 (2010).

V International Conference  
„ECOLOGY OF URBAN AREAS“ 2016

## AN INTRODUCTION ON LITERATURE OF SMART CITY

Ali Zeynali Azim<sup>\*1</sup>, Mostafa Basiri<sup>2</sup>, Mohammad Zeynali Azim<sup>3</sup>

<sup>1</sup>Young Researchers and Elite Club, Tabriz Branch, Islamic Azad University, Tabriz, Iran

<sup>2</sup>Department of Architecture, Ilkhchi Branch, Islamic Azad University, Ilkhchi, Iran

<sup>3</sup>Department of IT, BostanAbad Branch, Islamic Azad University, BostanAbad, Iran  
al.zeynali@gmail.com, m.basiry@yahoo.com, mo.zeynali@gmail.com

### ABSTRACT

*The city is one of human phenomena in the environment in order to housing, livelihoods, economic and social relations and so on. Time spending and deep dependence of human to different resources, feel the need to consolidate in one place and also need to collective life and their requirements, led to human housing in coordination with the natural environment and building information of their surrounding environment. In every culture and civilization, according to their specific characteristics and differences, city has a common and effective factor and the fundamental factor is human as the main users and beneficiaries of cities. Unfortunately, irregular migration to cities, especially metropolises has caused an uneven grow and led to the have many problems in provide services to citizens. To solve this problem, in recent decades many strategies offered in academic circles that smart city is one of the most important strategies. Smart city as an electronic city is able to provide uninterrupted service to users and citizens, but unlike electronic city which in residents only plays the role of the client, users and citizens in smart city play the role of source or capital of city. Unlike electronic city, smart city has not meet the needs of citizens alone, but in a reciprocal cycle, civilians as human and information capitals of city are encouraged to provide services for the city which results in the interaction of urban development. On the other hand, it should be noted that because of the extensive and high density of modern cities, these cities are not manageable and controllable by traditional methods of urban management anymore. This study attempts to explain the difference between smart city and electronic city using an overview of the history of creating cities. In this study, it has been tried to use the findings of other scholars in order to better understand these differences.*

**KEY WORDS:** *City, Smart City, Digital City, Smart City Architecture.*

### INTRODUCTION

Smart City is the fact has emerged that due to the increasing development of information technology in the city and in order to meet the new needs of citizens to information and hardware and software features in urban life. What moves a city toward smartness is not merely the use of electronic tools and communication system of the city but the use of these tools in order to improve the quality level of life for the citizens of city. Smart City has 6 elements that are both smart economics, smart, smart people, smart governance, smart mobility, smart environments and smart living. Each smart city has six smart elements include smart economics, smart people, smart governance, smart mobility, smart environments and smart life. Get ready to achieve smart city seems to be necessary in the virtualization processes at two levels of smart people and smart government. Smart people level includes education, e-learning, human capital and research, development and innovation and smart government level includes public costs on ICT, access to websites, public online services, transparent governance, e-democracy and promote ICT and innovation. In fact, Smart City is the fact has emerged that due to the increasing development of information technology in the city and in order to meet the new needs of citizens to information and hardware and software features in their urban life. Each smart component means opening a new concept in urbanism. What moves a city toward smartness is not merely the use of electronic tools and communication system of the city but the use of these tools in order to improve the quality level of life for the citizens of city. The plan of smart cities is a conscious effort to use information technology to transform life and work in our area in critical ways



instead of increasing ways. There is a conceptual and practical distinction between digital city and smart city. Smart city label is usually used to describe a city is able to support learning techniques, technology development and innovation. In this sense, every digital city is not necessarily smart, but every smart city has digital components.

## **SMART CITY**

The term "smart city" in recent years a lot of attention 1990 'in the late since many cities smart city initiatives In the European commission digital Agenda, cities such as health, environment, participation and work in areas such as innovation as drivers are accepted. The concept of smart cities captures different meanings and pure city marketing purposes period we need to look beyond a superficial use. (Zeynali Azim, Aghajani, 2014). The most effective definition of a smart city is a community that is efficient, live able, and sustainable— and these three elements go hand-in-hand. Traditionally, the water, gas, electricity, transportation, emergency response, buildings, hospitals, and public services systems of a city are separate and operate in silos independent of each other. A truly efficient city requires not only that the performance of each system is optimized, but also that these systems are managed in an integrated way to better prioritize investment and maximize value (Aoun, 2013). "Smart City" (Partridge, 2004) refers to a city where the ICT strengthen the freedom of speech and the accessibility to public information and to public services. The Smart City approach was initially applied in the case of Brisbane (Australia) and supported the social participation and the close of the digital divide. The Smart City notion has been evolved to an urban space for business opportunities. This approach has created a network of cities (Partridge, 2004). Based on our literature review of the field, we believe that in providing the most comprehensive definition of smart cities, urban performance should be gauged against a city's hard infrastructure and its attention to the environment; the accessibility to and use of information and communication technologies (ICTs), for both urban population and public administration (Graham, Marvin, 1996; Roller, Waverman, 2001); as well as its human and social capital, manifested in decisive factors such as the presence of a creative class (Florida, 2002), the education level of urban population (Berry, Glaeser, 2005; Glaeser, Berry, 2006), and the generation of Localized Knowledge Spillovers (LKS), originated from face-to-face contact between peers in an urban environment (Breschi, Lissoni, 2001; Fu, 2007; Capello, 2009). Furthermore, the smartness of a city should be measured by its participatory governance, its smart economy, its smart urban mobility, its smart environmental strategy and management of natural resources, and the presence of its self-decisive, independent, and aware citizens leading a high-quality urban life. (Roch, 2012).

### **Elements of a smart city**

Smart Cities are expected to dramatically improve their citizens' quality of life, encourage business to invest, and create a sustainable urban environment (Vasseur & Dunkels, 2010). Interestingly, while the term Smart City literarily implies an outcome or result, most usage of the term consider it as an 'activator' of change through exploring relevant open innovation processes (Paskaleva, 2011). Other conceptualizations such as (Nam, Taewoo; Pardo, 2011) consider smart city as urban innovation involving technological, organizational, and policy innovation. Finally, a Smart City could be understood as a certain intellectual ability that addresses several innovative socio-technical and socio-economic aspects of growth (Zygiaris, 2012). Three elements characterizing the Smart City concept identified in (Hollands, 2008) include:

- ✓ utilization of networked infrastructures to improve economic and political efficiency and enable social, cultural, and urban development; infrastructures including ICT;
- ✓ Business-led urban development and
- ✓ Social and environmental sustainability.

Social sustainability implies social cohesion and a sense of belonging, while environmental sustainability refers to the ecological and 'green' implications of urban growth and development. (Komninou, 2011) presents the concept of spatial intelligence of cities as a composite capability enabling communities within the city to harness the intellectual capital, institutions, and material

infrastructure in dealing with problems and challenges. Spatial intelligence is composed of three types of intelligence: 1) the inventiveness, creativity, and intellectual capital of the city; 2) the collective intelligence of the city's institutions and social capital; 3) the artificial intelligence of public and city-wide smart infrastructure, virtual environments, and intelligent agents. These three types of intelligence involve all dimensions of the city and map to three types of spaces – physical, institutional, and digital spaces. The “physical space” corresponds to the inventiveness and creativity of the city, the “institutional space” includes the social capital and collective intelligence of a city population, and “digital space” contains the artificial intelligence embedded into the physical environment, including public broadband communication infrastructure and digital technologies. (Ojo *et al.* 2014).

Focusing on the digital space, (Vasseur & Dunkels, 2010) identified the following infrastructure networks for smart cities. Some of these networks are related to transport, public safety and security, public services, utilities, and social networking. In the physical space, skills and human capital are considered as arguably the most important element. For instance, it is argued that the greatest competitive advantages of cities are qualities that attract the best and brightest from around the world to a city (Bloomberg, 2011). This is supported by the fact that educated cities grow more quickly than less educated ones, since skilled cities are economically more productive and better at adapting to economic shocks (Glaeser & Saiz, 2003).

We summarize the different elements of the definitions of the Smart City concept below in Table 1. Further discussions on the conceptualizations and definitions of the Smart City are provided in (Hollands, 2008), (Caragliu *et al.*, 2009) and (Nam, Taewoo; Pardo, 2011).

Table 1: Elements of “Smart Cities” Definitions

No	Description	Reference
Nature	<i>Is a</i> (1) forward-looking City in the areas of economy, people, governance, mobility, environment and lifestyle; (2) form of urban innovation; and (3) Intellectual Capital Profile of a City	Giffinger <i>et al.</i> 2007), (Nam, Taewoo; Pardo, 2011), (Zygiaris, 2012)
Essence	<i>Means to</i> (1) Information access, bridging digital divide, lifelong learning, social inclusion and economic development; sustainable economic growth and urban development, higher quality of life; and wise management of natural resources; (2) innovative socio-technical and socio-economic growth of a city	(Hollands, 2008), (Vasseur & Dunkels, 2010), (Zygiaris, 2012)
Approach	<i>Involves</i> (1) investments in human and social capital; (2) investment in traditional (transport) & modern (ICT) communication infrastructure; (3) promoting participatory governance and engagement of citizens; (4) technological, organizational and policy innovation	(Caragliu <i>et al.</i> , 2009), (Nam, Taewoo; Pardo, 2011)

### Smart City Model

It begins with the concept of an Urban System, which can be understood as a generic term for a process in any of the kinds of networks of systems mentioned above. Such Urban Systems may be elementary entities or may be complex entities composed from simpler entities. We then introduce the Urban Information Model as a means to structure and classify the many different types of information contained or flowing in these networks. From an information technology point of view, it is helpful to think of the Urban Information Model as a very large number of layers representing a common two-dimensional space, the territory of the urban environment, whether that is a single city or a metropolis. This Urban Information Model is illustrated in a highly simplified form in Figure 1. Such a model is often instantiated in a Geographic Information System (GIS), however increasingly social networking tools are taking this model in new directions.

The groups of layers are:

a. The Natural Environment group including topography, flora and fauna, natural resources, geology, and so forth.

- b. The Infrastructure group including the Built Environment (roads, bridges, tunnels, buildings, pipelines, electrical and communication lines, and so forth) as well as Things That Move (trains, boats, buses, and so forth) that is constructed on the Natural Environment.
- c. The Resources group representing materials that originate in and eventually return to the Natural Environment after passing through various processes of refining and consumption in the Services group as well as capacities that are temporarily consumed, for example by the passage of a vehicle over a bridge, and are then re-generated.
- d. The Services group representing many kinds of services, including transportation, energy, commerce, healthcare, and so forth. Many of these services consume or transform resources from the Resource group.
- e. The Social Systems group, including the locations and Actions of people, such as commerce and culture, laws, regulations, governance, and so forth that exploit the Services and Resources from these respective groups. This group contains the topmost and most interesting layer in which we find the People Systems. (Harrison C, Donnelly A 2011)

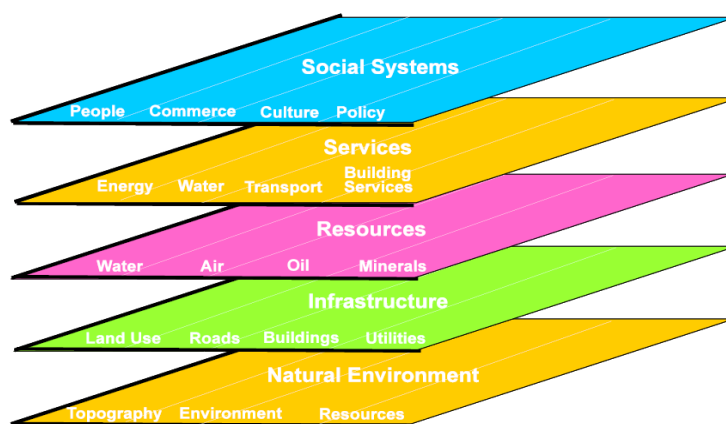

Figure 1: A simplified view of the Urban Information Model. Each plane represents a group of layers containing different, but related, types of information about the two-dimensional space.

### Characteristics Smart City

It is a mistake to think that making smarter cities requires just more investment in IT (Information Technologies) – what cities need to be able to do is to use IT as a means to deliver local (and national and EU levels) aims and objectives. The most important issue confounding efforts to make cities smarter is not the development of appropriate technologies per se, but to tackle the difficulties in changing organizations and existing ways of working to use these new technologies to deliver smarter cities. The concept of Smart Cities has also been used in different ways: to describe a cluster of innovative organizations within a region; the presence of industry branches that have a strong focus on ICT; business parks; the actual educational level of the inhabitants of a certain city; the use of modern technologies in an urban context; technological means that increase government efficiency and efficacy; etc. A clear definition remains elusive (Giffinger R, 2007)

In other literature the term Smart City is referred to the relation between the city government resp. administration and its citizen. Good governance as an aspect of a smart administration often also referred to the usage of new channels of communication for the citizens, e.g. “e- governance” or “e- democracy”. Smart City is furthermore used to discuss the use of modern technology in everyday urban life. This includes not only ICT but also, and especially, modern transport technologies. Logistics as well as new transport systems as “smart” systems which improve the urban traffic and the inhabitants’ mobility.

Moreover various other aspects referring to life in a city are mentioned in connection to the term Smart City like security/safe, green, efficient & sustainable, energy etc. To sum up, there are several

fields of activity which are described in literature in relation to the term Smart City: industry, education, participation, technical infrastructure, various ‘soft factors’; finally we can identify six characteristics (see Fig 2, Table 1) as a roof for the further elaboration of smart cities which should incorporate the findings but also allow an inclusion of additional factors. (Correia, et al. 2011). Thus the key characteristics of truly smart city is intelligent/knowledge communities of smart people and (Anthopoulos , Vakali , 2011) territorial institutions enabled with the eco-smart urban infrastructure, integrated and controlled by a Single Intelligent City Management Platform, the foundation of the Urban Internet of Systems, Services, Knowledge and Citizens (Abdoullaev, 2011).

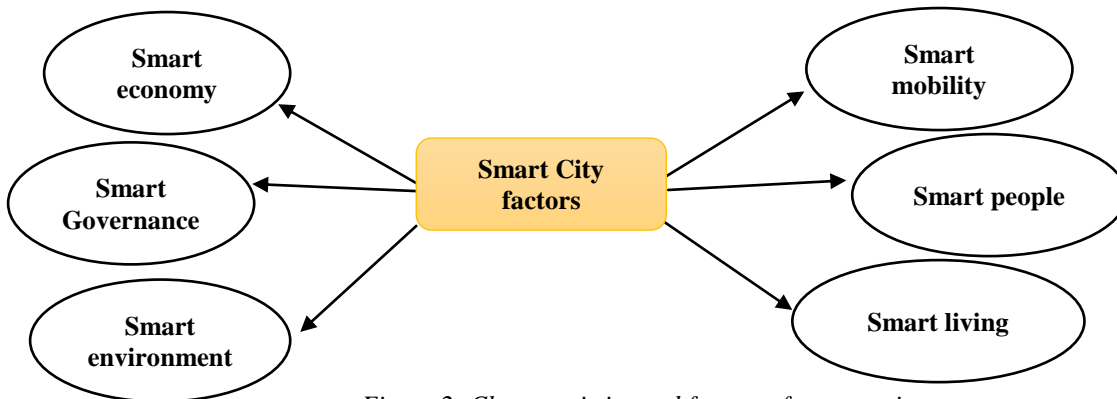

Figure 2: Characteristics and factors of a smart city

Table 1: Characteristics and factors of a smart city

Characteristics smart city	
<b>Smart Economy</b>	<ul style="list-style-type: none"> <li>• •Penetration of ICT use in businesses.</li> <li>✓ <input type="checkbox"/> PC and Internet usage in enterprises.</li> <li>✓ <input type="checkbox"/> Internet usage penetration for electronic commerce.</li> <li>• •Financial promotion.</li> <li>✓ Local development agencies.</li> <li>✓ <input type="checkbox"/> Strategies for the economic development of the city.</li> <li>• •Retaining and attracting talent and promoting creativity.</li> <li>• •Entrepreneurship. Support for entrepreneurship.</li> <li>• •Development of business spaces.</li> <li>✓ <input type="checkbox"/> Science and technology parks.</li> <li>✓ <input type="checkbox"/> Industrial parks.</li> <li>✓ <input type="checkbox"/> Business incubators.</li> <li>• •Internationalization of the city</li> <li>✓ <input type="checkbox"/> International promotion strategy for the city.</li> <li>✓ <input type="checkbox"/> Development of flagship projects for the city's international positioning.</li> <li>✓ <input type="checkbox"/> Participation in international networks.</li> </ul>

<p><b>Smart people</b></p>	<ul style="list-style-type: none"> <li>• •Education and training.</li> <li>✓ <input type="checkbox"/> Population with college degrees.</li> <li>✓ <input type="checkbox"/> Presence of a University in the City.</li> <li>✓ <input type="checkbox"/> Priority areas for educational offers.</li> <li>✓ <input type="checkbox"/> Adaptation of the educational offer to the current labour market demand.</li> <li>• •E-Learning.</li> <li>✓ <input type="checkbox"/> Plans for digital development in classrooms.</li> <li>✓ <input type="checkbox"/> Penetration of ICT use in education.</li> <li>✓ <input type="checkbox"/> Implementation of e-learning programmes.</li> <li>✓ <input type="checkbox"/> Life-long training.</li> <li>• •Human Capital</li> <li>✓ <input type="checkbox"/> Collaboration between companies and knowledge centres.</li> </ul>
<p><b>Smart Governance</b></p>	<ul style="list-style-type: none"> <li>• Local public spending on ICT.</li> <li>• Website availability.</li> <li>• Strategic plans to promote e-Government and ICT</li> <li>• On-line public services.</li> <li>✓ Percentage of services available on-line.</li> <li>✓ Major on-line services offered by cities.</li> <li>✓ Administration staff that use Internet-connected computers.</li> <li>• Electronic signature.</li> <li>• Transparent governance.</li> <li>• e-Democracy.</li> <li>✓ Citizen participation.</li> <li>✓ Electronic voting.</li> <li>• Promoting ICT and Innovation</li> </ul>
<p><b>Smart Mobility</b></p>	<ul style="list-style-type: none"> <li>• Connectivity and ICT infrastructure.</li> <li>✓ Penetration of ICT use in homes.</li> <li>✓ Internet usage.</li> </ul>

	<ul style="list-style-type: none"> <li>✓ Broadband coverage.</li> <li>✓ Broadband usage.</li> <li>✓ Mobile phone usage.</li> <li>✓ Mobile Internet usage penetration.</li> <li>• Public Internet Access.</li> <li>✓ Wi-Fi hotspots in cities.</li> <li>✓ Public Internet access centres.</li> <li>✓ Promotion deals with ISPs.</li> </ul>
<b>Smart Environment</b>	<ul style="list-style-type: none"> <li>• Security and trust.</li> <li>✓ Using ICT to improve public safety.</li> <li>• Culture and identity.</li> <li>✓ Initiatives for the digitization of heritage assets</li> </ul>
<b>Smart Living</b>	<ul style="list-style-type: none"> <li>• e-Health.</li> <li>✓ Electronic health card.</li> <li>✓ On-line medical services.</li> <li>✓ Remote home control or alarm systems for patients.</li> <li>• Accessibility and e-Inclusion.</li> <li>✓ Development of digital inclusion programmes for groups at risk of exclusion.</li> </ul>

### Smart City Architecture

The concept of ‘Smart city’ has been evolving over time (N. Komninos). At least four different descriptions of what an intelligent city is can be found in the literature and practice, largely involving innovation, smart growth, community spaces; namely:

- Virtual reconstructions of cities, smart representations, simulation cities, or virtual cities.
- Smart cities, an urban development based on information and communications technologies.
- Urban environments with embedded information and communication technologies creating interactive spaces that bring computation into the physical world. smart cities (or intelligent spaces more generally) refer to physical environments in which information and communication technologies and sensor systems disappear as they become embedded into physical objects and the surroundings in which we live, travel, and work.
- Territories that bring innovation systems and ICTs within the same locality, combining the creativity of talented individuals that make up the population of the city, institutions that enhance learning and innovation, and digital innovation spaces facilitating innovation and knowledge management.

Its most close synonyms are “innovation city”, ‘smart communities’ and ‘smart innovation environments’. For us, intelligent cities and regions are territories with high capacity for learning and innovation, which is built-in the creativity of their population, their institutions of knowledge creation, and their smart infrastructure for communication and knowledge management. The distinctive

characteristic of intelligent cities is their increased performance in the field of innovation, because innovation and solving of new problems are distinctive features of intelligence. In this sense, intelligent cities and regions constitute advanced territorial systems of innovation, in which the institutional mechanisms for knowledge creation and application are facilitated by digital spaces and online tools for communication and knowledge management. (Abdoullaev, 2011)

The notion of smart city has been also approached as part of the broader term of Smart City (Anthopoulos, Tsoukalas, 2006) by, where a generic multi-tier common architecture for Smart cities was introduced, and assigned smart city to the *software and services* layer. This generic architecture (Fig. 3) contains the following layers:

- *User layer* that concerns all e-service end-users and the stakeholders of a smart city. This layer appears both at the top and at the bottom of the generic architecture because it concerns both the local *stakeholders* –who supervise the smart city, and design and offer e-services- and the *end-users* –who “consume” the smart city’s services and participate in dialoguing and in decision making.
- *Service layer*, which incorporates all the particular e-services being offered by the smart city.
- *Infrastructure layer* that contains network, information systems and other facilities, which contribute to e-Service deployment.
- *Data layer* that presents all the information, which is required, produced and collected in the smart city.

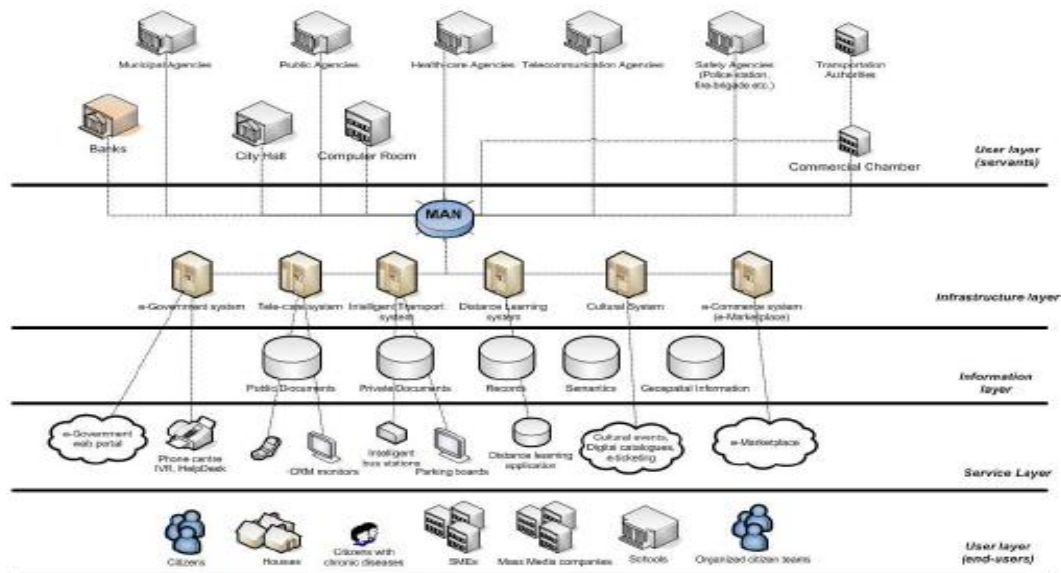

Figure 3: Smart cities layered architecture

## Smart City and Digital City

To better understand similarities, differences, boundaries and contents of smart city and digital city ideas, a deeper analysis of most important definitions has been carried out. In Table 2 and Table 3, respectively, the most cited and meaningful smart city and digital city definitions are listed. Smart city and digital city are often confused each other, and these two terminologies are used indifferently to indicate an innovative urban strategy, aiming at improving the quality of life in urban areas, especially in large cities. However, a deeper analysis of their meanings and their contents reveals that smart city and digital city define different development paths for cities, with different instruments to be used and different goals to be reached, even if smart city and digital city have several overlaps and common strategies. Similarities and differences in smart city and digital city have been evidenced, and they are useful to both drive local and central governments to orient their policies for urban innovation, and to measure and evaluate reached results for public administration and citizens in improving the quality of life in even larger and complex cities.

Table 2: Smart City Definitions

	Smart City Definitions	References
a	“A Smart City is a city well performing city built on the ‘smart’ combination of endowments and activities of self-decisive, independent and aware <b>citizens</b> ”.	Giffinger, 2007
b	“A city to be smart when investments in human and social capital and traditional (transport) and modern ( <i>ICT</i> ) communication infrastructure fuel sustainable economic growth and a high <b>quality of life</b> , with a wise management of natural resources, through participatory governance”.	Caragliu et. al. 2009
c	“Smart City is the product of <i>Digital City</i> combined with the <i>Internet of Things</i> ”.	Su, Fu, 2011
d	“A city that monitors and integrates conditions of all of its critical infrastructures, including roads, bridges, tunnels, rails, subways, airports, seaports, <i>communications</i> , water, power, even major buildings, can better optimize its resources, plan its preventive maintenance activities, and monitor security aspects while maximizing services to its <b>citizens</b> ”.	Hall 2000
e	“Smart City is a city in which it can combine technologies as diverse as water recycling, advanced energy grids and mobile communications in order to reduce environmental impact and to offer its <b>citizens</b> better lives”.	Setis-EU 2012
f	“A smart city is a well-defined geographical area, in which high technologies such as <i>ICT</i> , logistic, energy production, and so on, cooperate to create benefits for <b>citizens</b> in terms of well-being, inclusion and participation, environmental quality, intelligent development; it is governed by a well-defined pool of subjects, able to state the rules and policy for the city government and development”.	Dameri 2013

Table 3: Digital City Definitions

	Digital City Definitions	References
a	“A digital city is substantively an open, complex and adaptive system based on computer network and urban information resources, which forms a virtual <i>digital space</i> for a city. It creates an information service marketplace and information resource deployment center”.	Qi, Shaofu, 2001
b	“A Digital City has at least two plausible meanings: (1) a city that is being transformed or re-oriented through digital technology and (2) a <i>digital representation</i> or reflection of some aspects of an actual or imagined city”.	Schuler 2007
c	“The concept of Digital City is to build an arena in which <b>people</b> in regional communities can interact and share knowledge, experiences, and mutual interests. Digital City integrates urban information (both achievable and real time) and create public spaces in the <i>Internet</i> for people living/visiting the city”.	Ishida 2002
d	“Digital city denotes an area that combines broadband communication infrastructure with flexible, service- oriented computing systems. These new <i>digital infrastructures</i> seek to ensure better services for <b>citizens</b> , consumers and business in a specific area”.	Komninos 2008

## CONCLUSION

Today, the development of cities, pollution and related problems has led city officials and intellectuals to solve urban problems through smart city strategy. Smart city is a city has appropriate communication infrastructure, hardware, software, organization and human resources. The smart city is able to provide services produced by government sectors, institutions, organizations, companies, stores and other private sectors of a city in twenty-four hours a day, uninterrupted and safe for its citizens. The city is formed from citizens, transport, environment, infrastructure, and overall smart and training living in the use of advanced technologies. In such a city, geographical characteristics do not disappear, but making smart processes such as warp and weft of a network link through flows and signals, connect urban locations and functions to each other. In such a city being informative not only led to the isolation of the location citizens, but also on the contrary, places and families are formed in a smart space and have the possibility of communicate, exchange ideas and more services. In this city, urban managers with knowledge of departments and help of smart tools have better facilities for smart management of departments and areas they are in charge. The plan of smart cities is a conscious effort to use information technology to transform life and work in our area in critical ways instead of increasing ways. There is a conceptual and practical distinction between digital city and smart city. Smart city label is usually used to describe a city is able to support learning techniques, technology



development and innovation. In this sense, every digital city is not necessarily smart, but every smart city has digital components. Comments on the relationship between real and virtual city are different. Digital city includes every function of the city, such as work, housing, movement, recreation and the environment while smart city primarily includes functions of research, technology transfer, product development and technology innovation, as the context of innovative industries like the city of knowledge.

## REFERENCES

1. Aoun Charbel, (2013). The Smart City Cornerstone: Urban Efficiency, Schneider Electric White Paper Revision 0, 1-13.
2. Partridge, H., (2004). Developing a Human Perspective to the Digital Divide in the Smart City. In: “ALIA 2004, challenging ideas”, Queensland University of Technology Brisbane, Australia, 2004.
3. Berry, C.R., and Glaeser, E.L., (2005), The Divergence of Human Capital Levels Across Cities, *Papers in Regional Science*, 84 (3): 407–444.
4. Breschi, S. and Lissoni, F., (2001), Localized Knowledge Spillovers vs. Innovative Milieux: Knowledge ‘Tacitness’ Reconsidered, *Papers in Regional Science*, 80(3): 255–273.
5. Capello, R., (2009), Spatial Spillovers and Regional Growth: A Cognitive Approach, *European Planning Studies*, 17(5): 639–658.
6. Florida, R.L., (2002), *The Rise of The Creative Class and How It’s Transforming Work, Leisure, Community and Everyday Life*, New York: Basic Books.
7. Fu, S., (2007), Smart Cafe’ Cities: Testing Human Capital Externalities in the Boston Metropolitan Area, *Journal of Urban Economics*, 61 (1): 87–111.
8. Glaeser, E.L., and Berry, C.R., (2006), *Why Are Smart Places Getting Smarter?* Taubman Center Policy Brief 2006-2, Cambridge, MA: John F. Kennedy School of Government.
9. Graham, S., and Marvin, S., (1996), *Telecommunications and the City: Electronic Spaces, Urban Place*, London: Routledge.
- 10. Roller, L.H., and Waverman, L., (2001), *Telecommunications Infrastructure and Economic Development: A Simultaneous Approach*, *American Economic Review*, 91(4): 909-923.
11. Roche St, Nabian N, Kloeckl N and Ratti C. (2012). Are ‘Smart Cities’ Smart Enough? We live in the Global Location Age. “Where am I?” is being replaced by, “Where am I in relation to everything else?” Introduction of Penn State Geospatial Revolution Project: 215-235 (<http://geospatialrevolution.psu.edu/>).
12. Bloomberg, M. R. (2011). The Best and the Brightest - New York City’s bid to attract science talent could serve as a model for other cities. *Scientific American*, 305(3), 11.
13. Giffinger, R., Fertner, C., Kramar, H., Kalasek, R., Pichler-Milanović, N., & Meijers, E. (2007). Smart cities Ranking of European medium-sized cities. October: 1–28.
- Glaeser, E. L., & Saiz, A. (2003). *The Rise of the Skilled City* (No. No 25). Social Science Research. Cambridge, Massachusetts.
14. Hollands, R. G. (2008). Will the real smart city please stand up? Intelligent, progressive or entrepreneurial. *City: Analysis of Urban Trends, Culture, Theory, Policy and Action*, 12(March 2012), 37–41. doi:10.1080/13604810802479126
15. Nam, T., & Pardo, T. (2011). Conceptualizing Smart City with Dimensions of Technology, People and Institutions. In *The Proceedings of the 12th Annual Conference on Digital Government Research* (pp. 282 – 291). MD, USA: ACM Press.
16. Paskaleva, K. A. (2011). The smart city: A nexus for open the smart city: A nexus for open innovation? *Buildings*, 3(March 2012), 153–171. doi:10.1080/17508975.2011.586672
17. Vasseur, J.-P., & Dunkels, A. (2010). Smart Cities and Urban Networks. In *Interconnecting Smart Objects with IP The Next Internet* (335–351). Morgan Kaufmann. doi:10.1016/B978-0-12-375165-2.00022-3
18. Zygiaris, S. (2012). Smart City Reference Model: Assisting Planners to Conceptualize the Building of Smart City Innovation Ecosystems. *Journal of the Knowledge Economy*. doi: 10.1007/s13132-012-0089-4.
19. Ojo A, Curry E and Janowski T. (2014). DESIGNING NEXT GENERATION SMART CITY INITIATIVES - HARNESSING FINDINGS AND LESSONS FROM A STUDY OF TEN SMART CITY PROGRAMS, Twenty Second European Conference on Information Systems, (Tel Aviv 2014). 1-14.
20. Harrison C, Donnelly A (2011). A Theory of Smart Cities Proceedings of the 55th Annual Meeting of the ISSS - 2011, Hull, UK. 1- 15.
21. Giffinger R, (2007). Smart cities Ranking of European medium-sized cities, Centre of Regional Science, Vienna UT, October 2007, 1-28.
22. Correia, L M, Wüstel K and Lucent A (2011). Smart Cities Applications and Requirements, Net!Works European Technology Platform Expert Working Group.

23. Abdoullaev A, (2011). Keynote: "A Smart World: A Development Model for Intelligent Cities", The 11th IEEE International Conference on Computer and Information Technology. 1-28
24. Anthopoulos LG, Vakali A, (2011). Urban Planning and Smart Cities: Interrelations and Reciprocities, Springer-Verlag Berlin Heidelberg, adfa. 1-12
25. Anthopoulos, L., Tsoukalas, I. A. (2006). The implementation model of a Digital City. The case study of the first Digital City in Greece: e-Trikala. Journal of e-Government (Haworth Press, Inc.), Vol.2 (2).
26. Zeynali Azim A, Aghajani R, (2014). Designing Smart Cities, Indian Journal of Fundamental and Applied Life Sciences, Vol. 4 (S3).146-153. [www.cibtech.org/sp.ed/jls/2014/03/jls.htm](http://www.cibtech.org/sp.ed/jls/2014/03/jls.htm).
27. Caragliu A., De Bo C., Nijcamp P. (2009), "Smart city in Europe", 3rd Central European
28. Hall P. (2000), "Creative cities and economic development", Urban Studies, Volume 37, Issue 4, pp. 633-649.
29. Dameri R.P. (2013), "Searching for Smart City definition: a comprehensive proposal", International Journal of Computers & Technology, Volume 11, Issue 5.
30. Ishida T. (2002): "Digital City of Kyoto", Magazine Communications of the ACM – How the virtual inspires the real, Volume 45, Issue 7, pp. 76-81, ACM New York, NY, USA.
31. Giffinger R. (2007), Smart Cities: Ranking of European medium-sized cities, Centre of Regional Science, Vienna.
32. Su K., Li J., Fu H. (2011), "Smart City and the applications", IEEE International Conference on Electronics, Communications and Control (ICECC), pp. 1028-1031.
33. Setis-Eu (2012), [setis.ec.europa.eu/implementation/technology-roadmap](http://setis.ec.europa.eu/implementation/technology-roadmap)
34. Qi L. and Shaofu L. (2001), "Research on Digital City Framework Architecture", IEEE International Conferences on Info-Tech and Info-Net, Volume 1, pp. 30-36.
35. Schuler D. (2002), "Digital Cities and Digital Citizens", Digital Cities II: Computational and Sociological Approaches, Springer LNCS, Volume 2362, pp. 71-85.
36. Komninou N. (2008), "Intelligent Cities and Globalization of Innovation Networks", Routledge, London.

**Author Index**

Abdousalam A. ALGAIDI .....	160	Hamdije Memedi .....	109, 292
Abdoussalam A. KHALIF .....	166	Hamed ABDORHIM .....	160
Aca Božilov .....	309	Hosam BAYOUMI HAMUDA ....	75, 160, 166, 225
Adrian Eugen Cioabla .....	26, 219, 240	Ioana Ionel .....	12, 94, 252
Adrian Tenchea .....	26	Irena Nikolić .....	129
Adriana Raluca Wächter .....	94	Ivan Tasić .....	379
Aleksandar Dragasevic .....	373, 386	Ivana Mihajlović .....	133, 138, 151, 366
Aleksandar Đurić .....	12, 26, 30	Ivana Milašević .....	129
Aleksandar Tomović .....	69	Ivana Stanivuković .....	201
Aleksandra Mihailović .....	195, 201	Ivica Stamenković .....	309
Aleksandra Šučurović .....	324	Jelena Đuričić-Milanković .....	303
Ali Hgeig .....	151	Jelena Filipović .....	184
Ali Zeynali Azim .....	399	Jelena Jankov .....	379
Alina Gabriela Dumitrel .....	240	Jelena Kiurski-Milošević .....	184, 324
Amelija Đorđević .....	309	Jelena Marinković .....	201
Ana Štajminger .....	393	Jelena Prodanović .....	117
Andreja Naumoski .....	21	Jelena Radonic .....	143
Anita Grozdanov .....	292	Jordana Ninkov .....	195, 201
Arianit Reka .....	109	José María Quiroga Alonso .....	88
Aysun TUNA .....	278, 318, 359	Josip Naglić .....	393
Blagica Cekova .....	175	Jovan Bajić .....	133
Bobi Stoimenovski .....	21	Jovan P. Šetrajčić .....	46
Bogdana Vujić .....	26, 30, 129, 195, 209, 284	Jovanić Dušan .....	324
Bojan Batinić .....	259	Katerina Atkowska .....	109, 292
Bojan Damjanović .....	303	Kiril Lisichkov .....	109, 124, 292
Boris Obrovski .....	133, 298	Kosana Popović .....	189
Branislav Batinić .....	133	Kosta Mitreski .....	21
Branko Markoski .....	245	Krisztina Demény .....	179
Carlos Alberto Aragón Cruz .....	88	László Makra .....	12
Cătălin – Virgil Rădulescu .....	252	Lato Pezo .....	184
Čedomir Ribić .....	259	Luka Nenadović .....	303
Danco Davcev .....	21	Ljiljana Živković .....	60, 309
Daniel Bisorca .....	12	M. Vojinović Miloradov .....	267
Danijela Jašin .....	324	Maja Đogo .....	138
Darko Reba .....	366	Maja Sremacki .....	143
Delia-Gabriela Calinoiu .....	219	Maja Turk Sekulic .....	143
Dijana Đurović .....	129	Maria Dolores Coello Oviedo .....	88
Dorin Lelea .....	240	Marina Šćiban .....	117
Dragan Adamović .....	133, 143	Marjana Pardanjac .....	379
Dragana Kukić .....	117	Marko Vlahović .....	245
Dragana Štrbac .....	138	Mila Kavalić .....	245
Dragica Ivin .....	209	Miladin V. Ševaljević .....	155
Dušan Stanojević .....	189	Milan Dimkić .....	298
Dušana Banjac .....	201	Milan Pavlović .....	12, 26, 69, 155
E. Škrgić .....	38	Milena Tadić .....	129
Ekaterina Arabska .....	284	Milica Vučinić Vasić .....	195
Erhan Mustafa .....	124, 175	Milorad Živanov .....	201
Erika Eleven .....	379	Miloš Živanov .....	133
Erika Tobolka .....	245	Miljan Šunjević .....	366
Eshagh Shayegan .....	102	Mirjana Antonijević Nikolić .....	189
Fatemeh Mehrabi Sharafabadi .....	102	Mirjana M. Ševaljević .....	155
Filip Jovanovski .....	175	Mirjana Vojinović Miloradov ....	133, 151, 298, 366
Francisc Popescu .....	26, 30, 240	Mirko Marinkovski .....	109, 124, 292
Gavrilă Trif-Tordai .....	219, 240	Miroslav M. Stanojević .....	155
Goran Štrbac .....	138	Miroslav Vulić .....	30, 69
Gordana Ludajić .....	184, 324	Mladenka Novaković .....	55, 138, 151, 259
Gordana Ruseska .....	292	Mohamad Sakizadeh .....	102

Mohammad Zeynali Azim .....	399	Srđan Kovačević .....	298
Mostafa Basiri .....	399	Stanko Milić .....	195
Nadezda Ljubojev .....	209	Stefan Kuvendziev .....	109, 124, 292
Neda Nikolic .....	373, 386	Stevo K. Jačimovski .....	46
Nenad Živković .....	60, 309	Stojan N. Simić .....	155
Nevena Živančev .....	298	Svetoslav Lazarev .....	303
Nicolae Stelian Lontis .....	12	Tamara Ivetić .....	138
Nikola Boskovic .....	143	Tijana Marinković .....	259
Nikola Mišić .....	309	Una Marčeta .....	30, 259
Olivera Paunovic .....	143	V. Petrović .....	267
Pablo Maria Romero Pareja .....	88	V. Sajfert .....	267
Parisa ALIASGHARI KHABBAZI .....	318	V.M. Zorić .....	267
Parisa GÖKER .....	278, 359	Vesela Radović .....	284
Ramon Mihai Balogh .....	12	Veselin Bežanović .....	138
Reinhold Wächter .....	94	Vesna Vasić .....	117
Robert Lakatoš .....	195	Viktorija Bezhovska .....	175
S. Mirjanić .....	38	Višnja Mihajlović .....	55
S.S. Dmitrašinić .....	267	Vjekoslav D. Sajfert .....	46
Sabolc Pap .....	143	Vladan Paunovic .....	373, 386
Sanja Stanisavljev .....	245	Vladimir Šinik .....	331, 340, 348
Savka Adamović .....	195	Zita Šereš .....	117
Shaban Jakupi .....	109	Zoltan Kazi .....	129
Slavko Arsovski .....	69	Zoran Bozinovski .....	109, 124
Slobodan Janković .....	331, 340, 348	Žarko Vranjanac .....	60
Slobodan Miladinović .....	46	Željko Despotović .....	331, 340, 348
Snežana Jakšić .....	201		